

APRS

ABOUT APRS

The Automatic Packet/ Position Reporting System (APRS) was created by Bob Bruninga, WB4APR, of Maryland, U.S.A.. Bob Bruninga is the president of APRS Engineering LLC, which owns the trademark for APRS. Bob created the APRS protocol and developed a program called “APRSdos”, which is the official name of “APRS”. This program runs on the MS-DOS platform.

The idea of APRS came about in the late 1970's, and it has been constantly updated since its initial release in 1992. Today, many licensed versions have been released for many platforms (refer to page 4, “The APRS Program”). Versions include MacAPRS for the Macintosh, WinAPRS and APRSplus for Windows, javAPRS written in Java, and PocketAPRS which runs on the Palm III.

One of the latest creations for APRS is the TH-D7. The TH-D7 is an APRS data communicator radio.

The APRS protocol uses packet communications which are Unnumbered Information (UI) frames. The packet contains the position, station data, status, and messages. The position contains the latitude and longitude, the station data contains the station's information (call sign, output power, etc.), weather information (temperature, wind speed and direction, etc.), etc., the status is like your comment, and the message is like e-mail.

To enjoy APRS, you require a transceiver with a Terminal Node Controller (TNC), and an APRS program that runs on a personal computer. The TH-D7 has an internal TNC and also contains the APRS functions that are considered indispensable in a portable transceiver. For information on how to operate APRS on the TH-D7, refer to page 12, “USING THE TH-D7 AS A SIMPLE APRS STATION”.

The following section describes general usage of APRS on transceivers, TNCs, and personal computers.



APRS STATION CONFIGURATION

A basic APRS station configuration is as follows. The transceiver connects to a TNC and the TNC connects to the serial port of a personal computer which must have the APRS program installed.

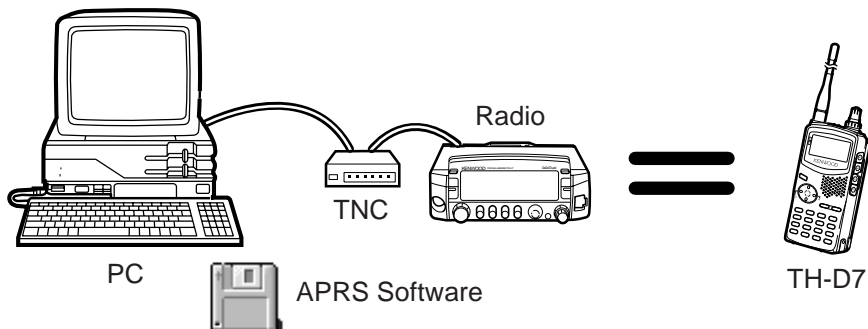

The configuration of a weather station consists of a weather observation instrument connected to one serial port on the personal computer, and the TNC connected to another serial port.

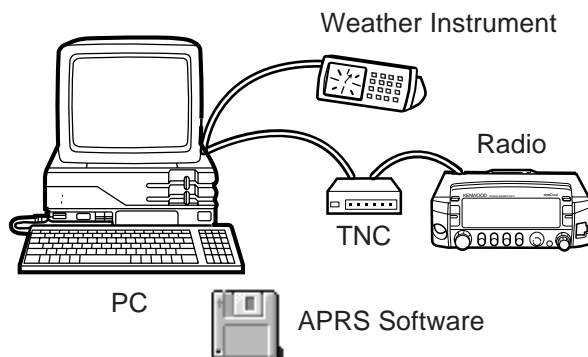

Mobile stations require a GPS receiver. The GPS receiver should be connected to one serial port on the personal computer and the TNC to another serial port. If the computer has only one serial port, the TNC should have GPS input.

APRS Mobile Station Configuration (Desktop PC)

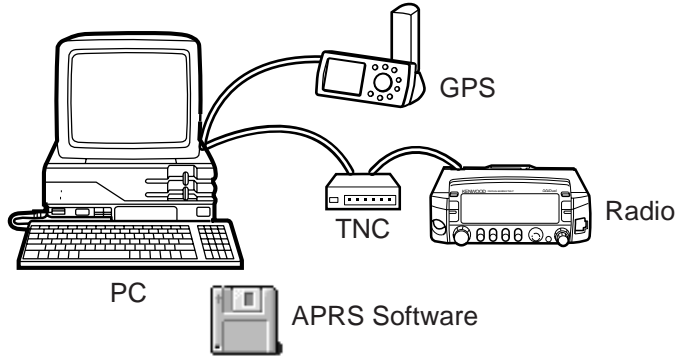

APRS Mobile Station Configuration (Laptop PC)

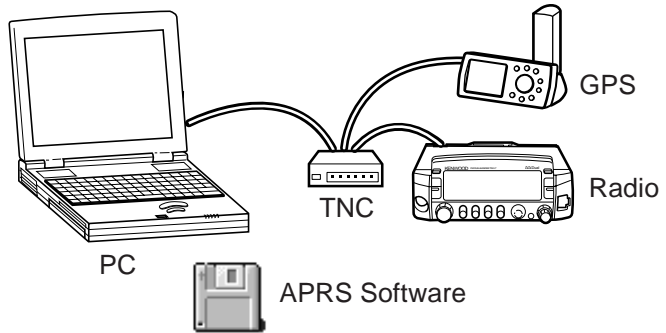

■ The APRS Program

The APRS program currently runs on a number of platforms. These programs are constantly being updated and can be downloaded from the Internet. Most programs are shareware and the latest versions are available at the TAPR (Tucson Amateur Packet Radio) FTP site: <ftp://ftp.tapr.org/aprssidg>

APRSdos (<ftp://ftp.tapr.org/aprssidg/dosstuff/APRSdos>)
Written by Bob Bruninga, WB4APR, the Father of APRS
Runs on MS-DOS.

MacAPRS (<ftp://ftp.tapr.org/aprssidg/macstuff/MacAPRS>)
Written by Mark Sproul, KB2ICI and Keith Sproul, WU2Z
Runs on Macintosh computers using Operating System 7 or higher.

WinAPRS (<ftp://ftp.tapr.org/aprssidg/winstuff/WinAPRS>)
Written by Mark Sproul, KB2ICI and Keith Sproul, WU2Z
Runs on Windows 95 or higher, or on Windows 3.1 + Win32s.

javAPRS (<ftp://ftp.tapr.org/aprssidg/javastuff>)
Written by Steve Dimse, K4HG
Runs on JAVA.

APRSplus (<ftp://ftp.tapr.org/aprssidg/winstuff/APRSPLUS>)
Written by Brent Hildebrand, KH2Z
Runs on Windows 95 or higher, or on Windows 3.1 + Win32s.

PocketAPRS (<ftp://ftp.tapr.org/aprssidg/palmstuff/palmapr>s)
Written by Mike Musick, N0QBF
Runs on Palm III.

- **Displaying Received Data**

When APRS data including position data is received, the icon and call sign of the station that sent the data will appear on the map displayed on your screen. The icon indicates the type of station, so you can see at a glance the type of APRS stations that are active in your area.

- **Tracking**

Mobile stations frequently send their position data. By receiving their positions, the APRS programs can track their movement. Movement is in real time, including speed and direction. You can save the tracked data to a file and replay it at a later time.

Two famous mobile stations in the past were the lead car of an Olympic marathon, and the Space Shuttle.

- **Maps**

Maps are usually included with the APRS program, so you can select the map of your area. Map data is frequently updated and is available at the TAPR ftp site (<ftp://ftp.tapr.org/aprssiG/maps/>).

- **Status**

APRS stations transmit status data packets and position data packets separately. These data packets have transmission interval times. Status data is the free text data called Status Text which is usually used for describing the station. Position data has a Position Comment. But some stations, such as a weather station's Position Packet, have meteorological data and cannot use a Position Comment.

- **Objects**

APRS allows information on natural disasters, such as hurricanes and tropical storms, to be transmitted as object data. This data includes location, direction of movement, and speed. When you receive such data, the object name appears on the map screen rather than the call sign of the transmitting station.

- **Meteorological Data**

APRS supports many meteorological instruments. You can connect them to your computer and send the real time data in APRS format with the location. By receiving real time data such as temperature and wind speed and direction, you can have beneficial information for surfing, hang gliding, mountain climbing, etc..



- **Messages**

APRS has a powerful message function. Two types of messages can be used: Addressed messages and bulletins.

Addressed messages allow you to use a call sign as an address, create a line message, and transmit it. The recipient returns the acknowledgment automatically. The message is resent at set interval times until an acknowledgment is returned. Digipeater and gateways (refer to page 9, "Networks") provide wide coverage area. A handheld transceiver like the TH-D7 can send messages from Los Angeles to New York with no troublesome setup procedure. APRS will also accept to send the message to Internet e-mail.

A bulletin is a message with no address. The purpose of a bulletin is to send multi-lined messages to all APRS stations. No acknowledgment is used because no recipient is specified.

- **GPS Receivers**

GPS receivers have become affordably priced. To use the GPS receiver, it must have NMEA-0183 format output (refer to page 7, "NMEA Format"). Most GPS receivers have this type of output. Mobile APRS stations with this type of GPS receiver can transmit their position in real time.

If your PC has 2 serial ports, connect the GPS receiver to one port and the TNC to the other, then use the APRS software to set up these devices.

If your PC has only one serial port, use a TNC that is equipped with a special input socket for a GPS receiver, such as the TH-D7. Alternatively, you can switch the serial port connection either automatically or manually between the TNC and the GPS receiver.

To connect the GPS receiver to the serial port on the PC, simply connect the Ground terminal of the GPS receiver to the SG (Signal Ground) terminal on the PC, and the Data Output terminal of the GPS receiver to the RD terminal on the PC.

Keep in mind that GPS receivers work in the 1500 MHz frequency range. Spurious emissions of 440 MHz or 1200 MHz transceivers may affect GPS signal reception. To avoid this, keep the GPS receiver and the transceiver as far apart as possible.



- **Latitude, Longitude, and Grid Square Locators**

APRS is designed to send and receive position data. Position data is described by latitude and longitude, expressed as “dd°mm.mm” (for example, 32°31.82 minutes). The decimal places are not seconds, they are actual decimal places.

You can establish your latitude and longitude using a GPS (Global Positioning System) receiver, or check it on a map which shows lines of latitude and longitude. When you operate in a fixed location, such as your home, a map is sufficient. When you operate as a mobile station, you need a GPS receiver to constantly identify your position.

Ham operators normally use the “Grid Square Locator” notation to explain their location. APRS allows the use of the Grid Square Locator notation when you cannot specify your exact latitude and longitude. A special data format is used for the purpose.

The Grid Square Locator divides the world into an 18 x 18 grid (324 areas), with each grid area assigned a name from AA to RR. Specify the grid square you are in, then divide that square into another 10 x 10 grid (100 squares). These squares are labeled 00 to 99. Each of these squares is then further divided into a 24 x 24 grid (576 sub-squares), labeled AA to XX. You can then obtain your exact location as a point between AA00AA and RR99XX (18,622,400 total grid squares).

- **NMEA Format**

NMEA-0183 is a standard used by the National Marine Electronics Association concerning interface with marine electronics devices. This standard contains electrical signals, data protocol and timing, and management of the serial signal bus.

In the electrical signal level, +5 V/0 V TTL level output and EIA-422 compatible interfaces are used. The baud rate is 4800 bps, there are 8 bits for data bits, there is no parity, and there is 1 bit for the stop bit.

All data starts with “\$” and ends with “<CR><LF>”. This data unit is called a sentence. A Talker identifier is represented by two characters which follow the “\$”, then characters showing the sentence format follows that. The data field is separated by commas. “ * ” shows the check sum field. <CR><LF> is at the end of the sentence.

The Talker identifier for a GPS receiver is GP. For example, “\$GPRMC” stands for an RMC sentence from a GPS (GP) device.

\$GPGGA = Global Positioning System Fix Data

\$GPRMC = Recommended Minimum Specific GPS/TRANSIT Data

\$GPGLL = Geographic Position - Latitude/Longitude.



■ TNC

APRS requires a Terminal Node Controller (TNC) that complies with the 1200 bps AX.25 protocol. The transfer speed between the PC and TNC can be set by the APRS software.

Some TNCs have built-in functions for APRS, such as direct connection to a GPS receiver and the Trace function which embeds the call sign into the signal when it is passed through a digipeater (refer to page 9, “Digipeaters”).

APRS packet data uses UI frames in converse mode. BTEXT is not used.

■ Transceivers

You can use any FM transceiver to operate APRS in the VHF/UHF band. Plug the transceiver audio output into the TNC. Connect the TNC modulated output and PTT signals to the transceiver. Connecting the transceiver and TNC ground terminals completes the connection. Finally, adjust the transceiver AF volume so the packet signals can be effectively decoded.

• Operating Frequencies

APRS originally began operating in the U.S.A. on 145.790 MHz, but is now available in most areas on 144.390 MHz. In southwestern Arizona, New Mexico, and Texas, APRS operates on 145.010 MHz. These regions are also preparing to shift to 144.390 MHz, however.

The HF gateway frequency is 10.151 MHz Lower Side band (10.1492 MHz MARK tone) for all areas.

■ Networks

APRS is a network system which uses Packet communications. VHF transceivers are limited in range, but with the use of digipeaters, you have nationwide APRS coverage. With the use of HF and Internet Gateways, you can access nationwide APRS stations.

- **Digipeaters**

Digipeaters are a function of TNCs and are an indispensable tool in packet communication. Using digipeaters, you can transfer packet data over longer distances. Unlike normal voice repeaters, which send and receive simultaneously on different frequencies, a digipeater sends and receives on the same frequency. Digipeaters do not send and receive at the same time, however. They store received packet data in the TNC memory until the end of reception, then they recall the data from memory and resend it. Packet data is rebuilt by the digipeater's TNC and it is transferred with no degradation. Digipeaters can relay the packet data from one repeater to the next, making it possible to transmit packet data over distances that cannot be attained by voice communications.

Generally, a digipeater relays (digipeats) data when the packet path includes the digipeater's own call sign (specified in the MYCALL command). APRS makes particularly good use of the way digipeaters operate. In fact, the growth of APRS to its current level is due in large part to the use of digipeaters.

How are digipeaters used in APRS? First, the digipeater uses either a WIDE or RELAY packet path. Most TNCs have a MYALIAS command which can assign a name other than MYCALL. For example, you send APRS data with the packet path WIDE, an APRS digipeater around your area with MYALIAS WIDE digipeats your data. WIDE type digipeaters are digipeaters that cover long distances. All other digipeaters are classified as RELAY digipeaters. Also, using a combination of RELAY and WIDE (the packet path will be RELAY,WIDE), your APRS data hops RELAY digipeaters first and then WIDE digipeaters. This means that a transceiver using APRS does not need to know the call sign of the digipeater. Simply by specifying "RELAY,WIDE" in its own packet path settings, it can send data over great distances. However, to reduce the APRS packet traffic, you should specify the digipeaters' call sign in the packet path. Without doing so, all RELAY or WIDE type digipeaters in your area will digipeat your data, creating unnecessary traffic.



- **HF Gateways**

A gateway is a digipeater that can relay packets between different frequencies. In APRS, HF gateways have been established to allow the thousands of VHF users to see what is happening on the HF APRS band. Most packets on the very low data rate (300 Baud) HF channel are automatically relayed by HF gateways into local VHF APRS networks everywhere. This is possible because the low data rate of HF does not significantly affect local VHF activity at higher baud rates. Other than for emergencies, APRS packets are not encouraged in the opposite direction where thousands of VHF users on VHF could instantly saturate the much slower HF channel and render it useless to everyone. The single HF channel can handle about 100 or so users nationwide whereas the hundreds of VHF nets can handle thousands of users independently. Yet, the thousands can still see what is happening on HF by the data coming to them via the HF-to-VHF gateways.

- **Internet Gateways**

An Internet gateway is a digipeater that relays data packets between radio frequencies and the Internet. APRS includes servers on which the APRServe software, written by Steve Dimse, is installed. The Internet gateway uses the Internet to connect to the APRS server and sends APRS data received in the VHF band to APRServe. Similarly, data received from the APRS server is transmitted on the VHF band. This extends the APRS network to cover the entire world. You can view data collected on the APRS server on the Web at www.aprs.net, www.aprs.org, and other locations. The APRS software also allows you to view the data by connecting directly to the APRS server. Refer to the descriptions of the Web and the software packages for more details.



■ Mic Encoder™

The Mic Encoder, owned by Bob Bruninga, was designed for convenient operation of APRS using a mobile station. This encoder was launched by the Tucson Amateur Packet Radio Corporation (TAPR). Following are the main features of this product. We noted from these features that the Mic Encoder minimizes the packet data and thus we selected this format for communication data using the TH-D7.

- It is installed between the transceiver and the transceiver microphone.
- It allows only data transmission.
- This format, designed by Bob Bruninga, contains approximately half the data bits used when compared with the basic APRS format.
- It is possible to connect directly to a GPS receiver.
- One of 8 possible messages is added to the position data and is transmitted. (This is called the Position Comment in the TH-D7.)
- It allows transmission of telemetry data.
- A personal computer is required to set up your call sign and various parameters.
- It does not allow APRS data communications because it does not have any character entry keys and it is not possible to receive packet.

You can select either Manual or Auto mode for data transmission from the Mic Encoder. In Manual transmission mode, when you release the PTT switch after voice transmission, a Burst transmission of packet data starts. However, the data is not transmitted each time the PTT switch is released. Data can be transmitted only when releasing the PTT switch after a preset transmitting interval.

In Auto transmission mode, packet data is transmitted in preset transmitting intervals. The TH-D7 inherits this transmission mode and the mode can be selected in menu 2–9 (DATA TX). In the TH-D7, interrelation is expressed as follows:

Mic Encoder	TH-D7	
Manual:	PTT:	Data is transmitted with a link to the PTT switch.
Auto:	Auto:	Data is transmitted in a certain interval.
	Manual:	Data is transmitted when [BCON] is pressed.

For more information, visit the TAPR home page at <http://www.tapr.org/>

USING THE TH-D7 AS A SIMPLE APRS STATION

A transceiver, TNC, and computer have always been needed to run APRS. **KENWOOD** has developed the TH-D7 transceiver as an easier and more convenient way of using APRS. The TH-D7 contains a built-in TNC and also includes the minimum program resources needed to operate APRS. Thus, the TH-D7 can run APRS as a stand-alone unit.

Do not forget that the TH-D7 is a dual band radio, allowing you to receive both voice signals and data packets simultaneously. For example, you can use the A band (the upper displayed band) for an APRS frequency and the B band (the lower displayed band) for VHF or UHF voice communication. You can even receive APRS data on the VHF band while you are talking on the UHF band by turning on the full duplex function.

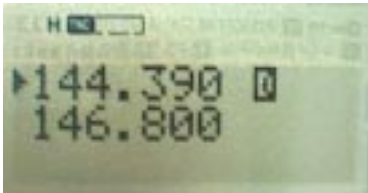

This section explains how to use the TH-D7 as a stand-alone APRS station, without using a GPS receiver, and provides some precautions regarding its use.

■ Setting Your Call Sign

To use APRS, you must first set up your call sign. Without your call sign, you cannot send APRS data.

Enter your call sign in the format stipulated by the AX.25 protocol. If you enter an invalid call sign, an error tone will sound and the call sign will be rejected.

Note:

- ◆ You can enter up to 6 alphanumeric characters for your call sign. When you include a SSID, you can enter up to 9 characters, but only 6 of those can be used for the call sign.
- ◆ Specify a number from 1 ~ 15 as the SSID. Enter a hyphen (-) between your call sign and the SSID. You cannot use more than 1 hyphen.

■ Setting Your Position

The most accurate method to determine your position is by using a GPS receiver. If you have a GPS receiver, refer to page 38, “USING THE TH-D7 WITH A GPS RECEIVER”.

You can enjoy APRS without a GPS receiver as well. All you need to do is use a map that shows lines of latitude and longitude. The more detailed the map, the better. If possible, pinpoint your position to within 1/100th of a minute (for example, North 35°31.82 minutes).

If you find this to be too difficult, purchase mapping software and install it onto your personal computer, then use it to check the latitude and longitude of desired locations. Some Internet Web sites provide maps with latitude and longitude.

If you do not set your position, you will not be able to check how far received data is from you, and the Position Limit function, menu item 2–C (POS LIMIT), will not function properly.

Note:

- ◆ Set menu 2–2 (GPS UNIT) to “NOT USED” when you do not use a GPS receiver.
- ◆ When you send APRS data, always include your position. The default setting of “N00°00.00, W000°00.00” is meaningless and may be inconvenient to other APRS stations.
- ◆ While you are entering the latitude and longitude, the grid square locator automatically appears in the top right of the screen.

■ Selecting a Position Comment

The TH-D7 transmits APRS data in the Mic-Encoder format. The Mic-Encoder format, devised by Bob Bruninga (WB4APR), includes 8 preset comments which you can select to best fit your current status. These comments cannot be deleted and are always included in the transmitted APRS data.

The available comments are:

- Off Duty
- In Service
- Committed
- PRIORITY
- Enroute
- Returning
- Special
- EMERGENCY!

Caution: EMERGENCY! is for emergency use only. Never use it for normal operation.



■ Entering Status Text

In addition to the position comment, a status text message of up to 20 characters can be added to the APRS packet data. Like the position comment, this data is always included with the transmitted data.















Note: To distinguish originally sent Mic-Encoder data from other data, the TH-D7 automatically adds the ">" symbol to the beginning of the status text. When the TH-D7 receives the data, the ">" symbol is not displayed.

■ Selecting Your Station Icon

APRS provides approximately 200 station icons. You can select and send whichever icon best suits your situation.

On the TH-D7, you can use the menus to select your station icon. The menu lists 15 widely used graphic icons for portable stations.

The 15 widely used graphic icons are:

		
KENWOOD (default)	SSTV	Triangle
		
Jogger, Runner	Aircraft (small)	Jeep
		
House QTH (VHF)	Ship (power boat)	RV
		
Campground, Portable	Car	Truck
		
Yacht	Motorcycle	Van

To select an icon other than those listed, select "OTHERS" and then chose the icon table and symbol. APRS icons consist of 2 bytes of data comprising of the icon table and icon symbol. The forward slash (/) is normally used to indicate the table, while the symbols are indicated by one of the following 94 keyboard symbols:

! "# \$ % & ' () * + , - . / 0 1 2 3 4 5 6 7 8 9 : ; < = > ? @ A B C D E F G H I J K L M N O P Q R S T U V W X Y Z [\] ^ _ ` a b c d e f g h i j k l m n o p q r s t u v w x y z { | } ~

To display more icons, a secondary icon table was created. The backslash (\) is used to indicate this table. For example, the CAR icon is expressed as ">", where "/" indicates the icon table and ">" indicates the icon symbol. For another example, the KENWOOD icon is expressed as "\K", where "\" indicates the secondary icon table and "K" indicates the icon symbol.

You can also add overlay characters to some icons. For example, you can add the number 3 to the CAR icon. When this icon data is received, "3" appears above and to the right of the car icon.

A list of the icons (as of February, 1999) is shown below.

/ \$	Primary Symbols	/ \$	Primary Symbols	/ \$	Primary Symbols
/ !	Police, Sheriff	/ 1	Numbered circle	/ B	BBS
/ "	Reserved	/ 2	Numbered circle	/ C	Canoe
/ #	DIGI (white center)	/ 3	Numbered circle	/ D	
/ \$	Phone	/ 4	Numbered circle	/ E	Eyeball
/ %	DX Cluster	/ 5	Numbered circle	/ F	
/ &	HF Gateway	/ 6	Numbered circle	/ G	Grid square (6 digits)
/ '	Aircraft (small)	/ 7	Numbered circle	/ H	Hotel (blue bed symbol)
/ (Cloudy	/ 8	Numbered circle	/ I	TCP-IP
/)	Available	/ 9	Numbered circle	/ J	
/ *	Snowmobile	/ :	Fire	/ K	School
/ +	Red Cross	/ ;	Campground	/ L	Available
/ ,	Reverse L shape	/ <	Motorcycle	/ M	MacAPRS
/ -	House QTH (VHF)	/ =	Railroad engine	/ N	NTS station
/ .	X	/ >	Car	/ O	Balloon
/ /	Dot	/ ?	Server for files	/ P	Police
/ 0	Numbered circle	/ @	HC Future predict	/ Q	T.B.D.
		/ A	Aid station		

/ \$	Primary Symbols
/ R	Recreational vehicle
/ S	Shuttle
/ T	SSTV
/ U	Bus
/ V	ATV
/ W	National WX service site
/ X	Helicopter
/ Y	Yacht (sail)
/ Z	WinAPRS
/ [Jogger
/ \	Triangle (DF)
/]	PBBS
/ ^	Large aircraft
/ -	Weather station (blue)
/ `	Dish antenna
/ a	Ambulance
/ b	Bike
/ c	T.B.D.
/ d	Dual garage (Fire dept)
/ e	Horse (equestrian)
/ f	Fire truck
/ g	Glider
/ h	Hospital
/ i	IOTA (Islands on the air)
/ j	Jeep
/ k	Truck

/ \$	Primary Symbols
/ l	Available
/ m	Mic-Repeater
/ n	Node
/ o	EOC
/ p	Rover (puppy)
/ q	Grid SQ shown above 128 m
/ r	Antenna
/ s	Ship (power boat)
/ t	Truck stop
/ u	Truck (18 wheeler)
/ v	Van
/ w	Water station
/ x	xAPRS (UNIX)
/ y	YAGI @ QTH
/ z	
/ {	
/	Reserved (Stream switch)
/ }	
/ ~	Reserved (Stream switch)











\ \$	Secondary Table
\ !	Emergency (!)
\ "	Reserved
\ #	Numbered star (green)
\ \$	Bank or ATM (green box)
\ %	
\ &	Numbered diamond
\ '	Crash site
\ (Cloudy
\)	
\ *	Snow
\ +	Church
\ ,	
\ -	House (HF)
\ .	
\ /	
\ 0	Numbered circle
\ 1	
\ 2	
\ 3	
\ 4	
\ 5	
\ 6	
\ 7	
\ 8	
\ 9	Gas station (blue pump)
\ :	Hail
\ ;	Park/Picnic area









\ \$	Secondary Table
\ <	Advisory
\ =	
\ >	Numbered car
\ ?	Info Kiosk (blue box with "?" in it)
\ @	Hurricane/Tropical storm
\ A	Numbered box
\ B	Blowing snow
\ C	Coast Guard
\ D	Drizzle
\ E	Smoke
\ F	Freezing rain
\ G	Snow shower
\ H	Haze
\ I	Rain shower
\ J	Lightening
\ K	KENWOOD
\ L	Lighthouse
\ M	
\ N	Navigation buoy
\ O	
\ P	Parking
\ Q	Quake
\ R	Restaurant
\ S	Satellite/Pacsat
\ T	Thunderstorm
\ U	Sunny
\ V	VORTAC Nav Aid

\ \$	Secondary Table
\ W	Numbered NWS site (NWS options)
\ X	Pharmacy Rx
\ Y	
\ Z	
\ [Wall cloud
\ /	
\]	
\ ^	Numbered aircraft
\ -	Numbered WX site (green digi)
\ `	Rain
\ a	ARRL ARES etc
\ b	Blowing dust/sand
\ c	Numbered civil defense (RACES)
\ d	DX spot by call sign
\ e	Sleet
\ f	Funnel cloud
\ g	Gale flags
\ h	HAM store
\ i	Indoor boxn digipeater (with overlay)
\ j	Workzone (steam shovel)
\ k	

\ \$	Secondary Table
\	Area locations (box, circles, etc)
\ m	Value signpost (3 digit display)
\ n	Numbered triangle
\ o	Small circle
\ p	Partly cloudy
\ q	
\ r	Restrooms
\ s	Numbered ship/boat (top view)
\ t	Tornado
\ u	Numbered truck
\ v	Numbered van
\ w	Flooding
\ x	
\ y	
\ z	
\ {	Fog
\	
\ }	
\ ~	

The TH-D7 can display the following graphics in the received station list. The icon table entry is shown in the “/” column and the icon symbol is shown in the \$ column. Icons with the backslash (\) for the icon symbol are in the secondary table. The # symbol in the “/” column represents overlay characters (numbers).

Icon	/	\$	Name
	\	K	KENWOOD (default)
	/	[Jogger, Runner
	/	-	House QTH (VHF)
	\	-	House (HF)
	/	y	Yagi @ QTH
	/	;	Campground, portable
	\	;	Park/Picnic area
	/	Y	Yacht
	/	T	SSTV
	/	V	ATV
	/	'	Aircraft (small)
	/	^	Aircraft (large)
	#	^	Numbered aircraft
	/	g	Glider
	/	X	Helicopter
	/	s	Ship (power boat)
	#	s	Numbered ship/ boat
	/	>	Car
	#	>	Numbered car
	/	P	Police car
	/	<	Motorcycle
	/	b	Bicycle

Icon	/	\$	Name
	\	n	Triangle
	#	n	Numbered triangle
	#	0	Numbered circles
	#	A	Numbered boxes
	/	j	Jeep
	/	R	RV
	/	U	Bus
	/	k	Truck
	/	u	Truck (18 wheeler)
	#	u	Numbered truck
	/	f	Fire truck
	/	v	Van
	#	v	Numbered van
	/	a	Ambulance
	/	#	Digipeater
	#	#	Numbered digipeater
	/	&	Gateway
	#	&	Numbered gateway
	/	I	TCP-IP
	/	_	Weather station
	#	_	Numbered weather station
	/	W	National WX service station
	#	W	Numbered NWS site

When the TH-D7 receives the XYZ icons that are used for a GPS tracker, the XYZ icons can be displayed. Refer to the symbol.txt file located in the Readme directory of the APRS dos software.

■ Setting the Transmit Method

You can select any of 3 methods to transmit your position as APRS data: MANUAL, AUTO, and PTT (accessed using menu 2–9 (DATA TX) in the APRS menu).

- **MANUAL**

The TH-D7 only transmits APRS data when you press **[BCON]**.

- **AUTO**

The TH-D7 transmits APRS data automatically by using the TX INTERVAL setting.

- **PTT**

Data is sent after you use the **[PTT]** switch for voice communication. Data transmission begins when you release the **[PTT]** switch. This method uses a Mic-Encoder to prevent unnecessary data transmission.

TX INTERVAL: In the AUTO and PTT modes you must specify a time interval using menu 2–7 (TX-INTERVAL) in the APRS menu. In AUTO mode, data is transmitted automatically at the specified interval. In PTT mode, data is queued for transmission when the specified interval has elapsed. Once the data is queued, the BCON icon on the TH-D7 screen starts blinking. Press and release the **[PTT]** switch to send the data.

A suitable interval for mobile operation is 1 to 3 minutes. For a fixed station, a good interval is between 10 and 30 minutes.

Note:

- ◆ *Do not send APRS data without setting your position.*
- ◆ *Do not set the TX INTERVAL too short. A short interval time creates heavy traffic on the APRS frequency.*



■ Setting the Digipeater Path (Digipath)

In APRS, it is very important that you set the digipeater path (also known as the packet path). These settings are dependent on how and where you use the TH-D7.

Following is an explanation on how to transfer data to distant stations more efficiently.

• Operating as a Fixed Station

How do you determine the type of digipeaters around your location?

Open menu 2–8 (PACKET PATH) and set the packet path to WIDE only, then send APRS data using this setting. If “MY PACKET” appears on the bottom of the TH-D7 display immediately after transmission ends, there is a WIDE digipeater within range and the packet path setting is fine. If “MY PACKET” does not appear, re-send the data several times.

If you cannot find a WIDE digipeater in your vicinity, the WIDE setting is not appropriate. In this event, change the menu 2–8 (PACKET PATH) setting in the APRS menu to RELAY only, then send the data again. This time, you need to determine the number of times the TH-D7 beeps when MY PACKET appears on the screen. Each beep corresponds to one RELAY station.

If there is only one RELAY station, use the “RELAY,WIDE” setting. If there are 2 or more RELAY stations, connect the TH-D7 to your computer (refer to page 41, “USING THE TH-D7 WITH A PERSONAL COMPUTER (AND GPS)”) and run the APRS program. Look for the nearest RELAY digipeater on the digipeater list, then specify the call sign in place of “RELAY” in the packet setting. For example, if the call sign of the digipeater you found is “WD6DJY”, specify “WD6DJY,WIDE”.

If you do not have an APRS program installed on your computer, ask a local APRS station or set the packet path to “RELAY,WIDE” for the time being.

• Operating as a Mobile Station

If you are a mobile station, it is difficult to always be aware of the types of digipeaters in your vicinity. Accordingly, use the default packet path setting (RELAY,WIDE).



■ Unprotocol Setting

Unprotocol usually describes the data type. For example, APRS data sent using APRSDos becomes APRnnn in unprotocol (“nnn” represents the version number). Data sent using WinAPRS becomes APWnnn and data sent using APRSplus becomes APnnnn.

The unprotocol for data sent using APRS programs always begins with AP. For this reason, the TH-D7 default setting is APK001 (**AP**rs **K**enwood version **001**).

For normal use, you do not need to change this setting.

In APRS, received data can be filtered by changing the unprotocol, so you only receive the desired type of data. Three types of settings can be used: All Calls, Special, and Alternate Net.

• All Calls

The TH-D7 receives the following unprotocols:

AP****, BEACON, ID, CQ, QST, MAIL, SKYWRN, GPS, and SPCL.

By setting the unprotocol of your station to one of these, you can set your TH-D7 to receive APRS data with a character string that matches any of them. Data that does not match any of these unprotocols is not received. However, data in the Mic-Encoder format and the GPSxyz and SYMxyz format can always be received.

The following SPCL unprotocols for special events can be received even if you select ALL CALLS.

BEACON: The only “UNPROTO TO” address for KANTRONICS TNCs when they transmit their BEACON text.

ID: The “TO” call for all TNC ID packets (HID command).

CQ: Generally selected as an initial parameter of TNC.

QST: The general “Q” code for “calling all radio amateurs”.

MAIL: The UNPROTOCOL (TOCALL) used by many BBS programs to send out a beacon listing those stations for which they have mail.

SKYWRN: NWS (National Weather Service) data.

GPS: Represents a stand-alone station coupled with a GPS receiver.

“GPSxyz”: A character string adding icon information followed by GPS.

SYM: Allocated for future use; presently not used.

“SYMxyz”: A character string adding icon information followed by SYM.



- **Special**

This setting is used for special events. If you set your station unprotocol to SPCL, received data that is not SPCL data is ignored.

Special events are such things as the installation of the APRS system in the leading car for an Olympic marathon, or any local events. The SPCL unprotocol was specified for these events and could be used by people wanting to receive only the APRS data transmitted by those stations and not be bothered by other traffic on the channel.

- **Alternate Net**

This unprotocol is used for transmissions within a group. By setting an unprotocol character string that is not included either in All Calls or Special, data can be exchanged only among the group of stations that all use the same character string as the unprotocol.

There are a number of precautions that should be observed. Because the TH-D7 uses the Mic-Encoder format, all Position and Status data transmitted by the local station is received by all stations using APRS. Only the message data uses the Alternate Net semi-privacy feature.

This happens because in the Mic-Encoder format, the latitude data and position comment are compressed and embedded in the unprotocol portion. The unprotocol character string specified in "UNPROTOCOL" in the TH-D7 APRS menu is not reflected in the station position transmission data. It is only used to filter the received data.

However, in the TH-D7 message function, the unprotocol is valid for both sending and receiving. This is because the Mic-Encoder format is only applied to the position data.

Refer to the figures below showing the correspondence between the local station settings and the types of data that can be received.

Local Station Settings and Received Data:

All Data Received with Mic-E (TH-D7), GPSxyz, and SYMxyz:

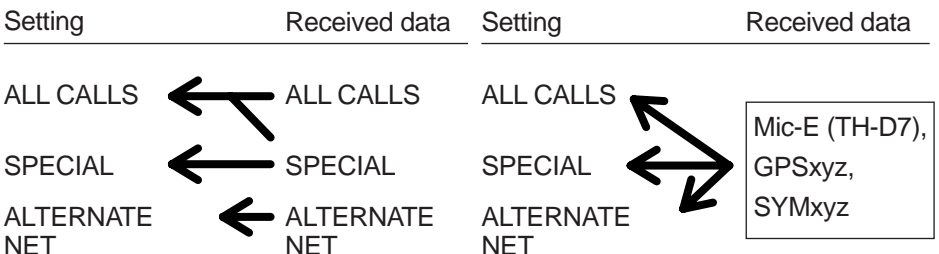

■ How to Receive APRS Data on the TH-D7

It is a very simple process to receive APRS data on the TH-D7. All you need to do is select the APRS frequency, then press **[TNC]**. (“PACKET” must not be displayed at this point.) “OPENING TNC” is momentarily displayed at the bottom of the screen. The TH-D7 is now ready to receive APRS data.

When you receive APRS data, the pop-up screen appears and an arrival tone sounds. The transmitting station’s call sign and status text appear on the screen for about 10 seconds before the original display reappears. If you receive object data, the object name is displayed instead of the call sign.

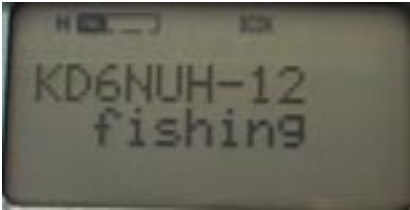

APRS Position Data is Received

- **Data Memory**

The TH-D7 can hold up to 40 stations of data in memory. When it receives data from the 41st station, the oldest data is automatically cleared. When the received data is from a station already in memory, the previous data is overwritten by the new data. Overwritten data goes to the top of the list.

- **Position data**

The TH-D7 has a function that restricts the received position data (Position Limit). This function is accessed using menu 2-B (POS LIMIT). When you turn this function OFF, all data is received. When a Position limit is specified, data from stations beyond that distance is not stored.

In the U.S.A. in particular, about 200 stations can be received when you monitor the APRS frequency for an hour. Some of this data is from too far away and may not be useful. If you are interested in the weather data for your current region, unwanted data may swamp the 40-station memory. The Position limit is useful in this type of situation.

You can restrict the range of data reception. This function limits reception to a radius of n miles (or kilometers) centered on your position. Data transmitted from outside that radius is not received. You can specify any value between 10 and 2500. Specifying OFF switches this function OFF, so all data is received.

• **Notification Messages**

When APRS data is received, the call sign may appear on the bottom of the screen without the pop-up screen being displayed. In this case, data with the same status text has been received from the same station. This avoids the annoyance of having the pop-up screen displayed repeatedly when the same data is received a number of times. When this occurs, a message such as “dP WD6DJY” appears on the bottom of the screen. A number of notification messages of this sort are displayed on the bottom of the screen. Some examples are shown in the table below.

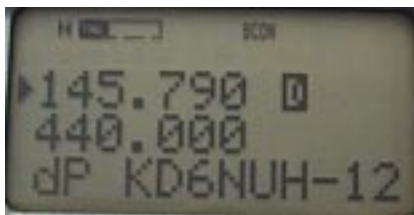

dP Display

dP WD6DJY	You have already received data from WD6DJY that contains the same status text.
dS WD6DJY	You have already received data from WD6DJY that contains the same status packet contents.
>P WD6DJY	You have received data from a station which is beyond the Position Limit. (This data is not stored in memory.)
dM WD6DJY	You have already received a message with entirely the same content.
oM	You have received a message addressed to another station. (This message is not stored in memory.)
rM WD6DJY	You have sent a message to WD6DJY, but it has been rejected for some reason.
Q? WD6DJY	You have received a query packet from WD6DJY.
dD	You have already received exactly the same DX cluster data. ¹
?? WD6DJY	You have received data from WD6DJY, but the TH-D7 cannot read it.

¹ The TH-D7 can store the DX Cluster data.

Note: The built-in TNC works only on the DATA band, selected in menu 1–4–1 (DATA BAND). The data band is indicated by “D”.

■ How to Read the Received Stations Data

Received APRS data is stored in your transceiver's memory and you can view it later.

- 1 Press **[LIST]** to view the list of stations you have received. The station call signs are listed on the screen with the most recent shown first.



Use the 4-way cursor key to view all the listed stations.

[^]/[v] ([UP]/[DWN]) Selects the station.

[<]/[>] ([ESC]/[OK]) Shows detailed data of the selected station.

- 2 Press **[UP]/[DWN]** to select the call sign of the station that you want to view, then press **[OK]**.

Information shown here is the status text. If the data was sent from a PC using APRS software, two types of text data can be accessed. The first is the comment text added to the position data. The second is the status packet. Up to 20 characters can be stored and displayed. The 21st and subsequent characters are discarded.

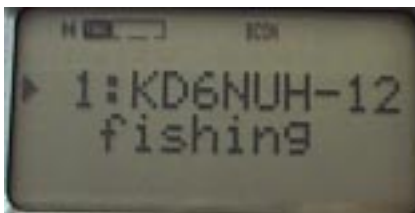

- 3 Press **[OK]** again to display the following information:

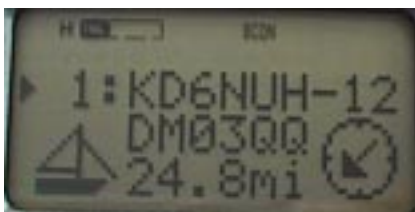

- Icon

The graphic icons that can be displayed on the TH-D7 are shown below. Other icons are displayed as a combination of 2 or 3 characters. The first character indicates the icon table. The second indicates the icon symbol. The third character may indicate GPS trackers XYZ-format icon data. Refer to page 14, “Selecting Your Station Icon”, for details.



- Grid Square Locator

The TH-D7 calculates the Grid Square using the received position information. The TH-D7 does not support reception or transmission of the APRS Grid Square Locator format.

- Distance from Your Station

Latitude and longitude data of My Position and the received station position are used for calculating the distance geographically. Press **[POS]** to confirm My Position.

Use menu 2–C (UNIT) to select miles or kilometers as the unit.

Distances under 100 (miles or kilometers) are displayed to 1 decimal place. The maximum distance that can be displayed is 9999. Distances greater than that are displayed as “xxxx”.

When the latitude and longitude values of the received data are 0, the distance is always shown as “xxxx”.

- Direction from Your Station to the Sending Station

Latitude and longitude data of My Position and received station position are used for calculating the direction geographically. Using My Position as a starting point, the direction of the station is displayed graphically as one of 8 compass points. The top of the screen is used as North.



For example, when the station from which you have received data is to your southeast, the display to the right appears on your screen:



- 4 Press **[OK]** again to display the latitude and longitude data.
- Latitude:
N for latitude North and S for latitude South.
yy°yy.yy: Degrees, minutes, and 2 decimal places.
 - Longitude:
W for longitude West and E for longitude East.
xxx°xx.xx: Degrees, minutes, and 2 decimal places.



APRS software allows you to use an “ambiguous position” specification. When the TH-D7 receives data with an ambiguous position, the latitude and longitude columns are left blank. The ambiguous position of the distance from the station and direction uses 0 for calculations.

- 5 Press **[OK]** again to display the information listed below. This information varies, depending on the type of data received.
- 1) Mobile station data (data sent using a TH-D7 or Mic-Encoder): The top line on the screen shows the call sign. The middle line shows the position comment. The bottom line shows the speed and direction of movement.
 - cse***°
The direction of movement is displayed with 0° for North and 90° for East.
 - s***m (or s***k)
The speed of movement is displayed in miles (or kilometers) per hour.



- 2) Mobile station data (data sent by other means): The top line on the screen shows the call sign. The middle line is blank. The bottom line shows the speed and direction of movement (same as point 1).

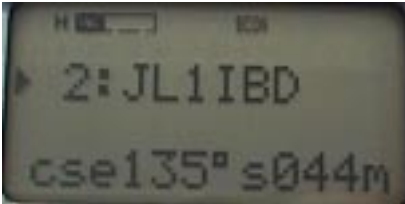

- 3) Fixed station data (with PHGD): The top line on the screen shows the call sign. The middle and bottom lines show the fixed station information (power, height, gain and directivity).

- pw**W

This shows the transmission power (in watts). A value of 0, 1, 4, 9, 16, 25, 36, 49, 64, or 81 W is displayed.

- h**** (h****M)

The altitude of the antenna is measured in feet (or meters). This value is not the height above sea level. Rather, it indicates the height of the antenna, relative to the average altitude of the area within a 10 mile radius of the antenna (Height-Above-Average-Terrain).

The units can be switched to meters (M) in menu 2-C (UNIT).

A value of 10, 20, 40, 80, 160, 320, 640, 1280, 2560, or 5120' (feet), or 3, 6, 12, 24, 49, 98, 195, 390, 780, or 1561 M (meters) is displayed.

- ant*dB

This shows the antenna gain (in decibels). A value of 0, 1, 2, 3, 4, 5, 6, 7, 8, or 9 dB is displayed.

- d***°, omni

This shows the antenna directivity. The directivity is displayed in 45° increments with North displayed as 360°, East as 90°, and South as 180°. Non-directional antennas are displayed as "omni".

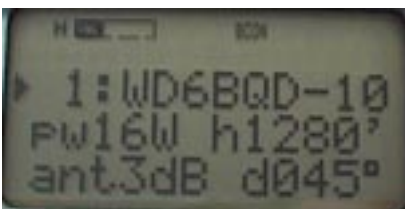

- 4) Fixed station data (with compressed format): The top line on the screen shows the call sign. The middle line is blank. The bottom line shows the radius of the transmission coverage as *** miles.
- 5) Fixed station data (with no information appended): The top line on the screen shows the call sign. The middle line is blank. The bottom line shows "cse---°s---m" (s---k).
- 6) Object data (with course and speed data): The top line on the screen shows the object name. The middle line shows the speed and direction of movement. The bottom line shows the call sign of the transmitting station.
 - cse***°
This shows the direction of movement with 0° for North, 90° for East, and 180° for South.
 - s***m (s***k)
This shows the speed of movement in miles (or kilometers) per hour.
 - fm:*****
This shows the call sign of the station that sent the object data.

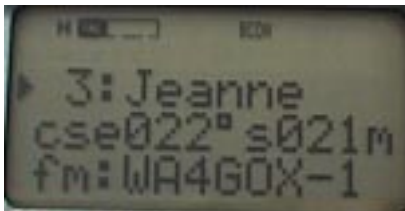

- 7) Object data (with no course or speed data): The top line on the screen shows the object name. The middle line displays "OBJECT". The bottom line shows the call sign of the transmitting station.
 - fm:*****
This shows the call sign of the station that sent the object data.

8) Meteorological (weather) data: The top line on the screen shows the call sign. The middle and bottom lines show the meteorological data.

- dir***°

This shows the wind direction, with 0° for North, 90° for East, and 180° for South.

- s***m (s***k)

This shows the wind speed in miles (or kilometers) per hour.

- t***F (t***C)

This shows the air temperature in derees Fahrenheit (or degrees Celsius).

- r*.***" (r***mm)

This shows the recent hourly rainfall in inches (or millimeters).

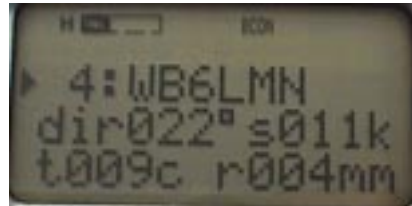
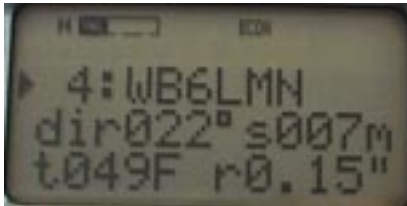

MESSAGES

The APRS message function is very powerful. You can use the TH-D7 to send and receive messages throughout the extensive area covered by digipeaters and gateways. For example, in the U.S.A., a user living in California can send a message to a friend in Florida using the TH-D7 alone. This is possible due to the Internet gateways in each region.

The TH-D7 message and bulletin functions are as follows.

Messages:

- You are notified about new messages by an icon and a beep tone. The display backlight also turns ON.
- The maximum text size of received and transmitted messages is 45 characters.
- You can store up to 16 messages, including bulletins.
- When the TH-D7 receives a message, an acknowledgment is automatically returned to the sender.
- The sending station transmits the message until an acknowledgment is returned, up to a maximum of 5 times. Transmission stops when an acknowledgment is received.
- The transmission interval is fixed at 1 minute.

Bulletins:

- The TH-D7 receives all bulletins.
- The maximum text size of received and transmitted bulletins is 45 characters.
- No acknowledgment is returned for a bulletin, as it has no set destination.
- The bulletin is resent 5 times at 1 minute intervals.



■ Entering a Message

Procedure for entering a message or bulletin on the TH-D7:

- 1 Press **[MSG]**.
- 2 Select "INPUT", then press **[OK]** to switch to message input mode.

3 *For a message:*

Type the destination call sign in the "TO:" field.

For a bulletin:

Type BLNn in the "TO:" field (n represents the bulletin line number). For example, the first time you type in a bulletin, type BLN0. The second time, type in BLN1.

- 4 Press **[OK]**.
- 5 Enter a message of up to 45 characters, then press **[OK]**.
 - The message or bulletin is sent.

When you send a message to a station on the APRS received stations list, the destination call sign is entered automatically:

- 1 Press **[LIST]** to display the APRS received stations list, then highlight the destination call sign.
- 2 Press **[MSG]**.
 - The call sign is automatically copied into the "TO:" field.
- 3 Enter a message of up to 45 characters, then press **[OK]**.
 - The message is sent.

When no acknowledgment is returned and you want to re-send a message that has already been sent 5 times:

- 1 Press **[MSG]**.
- 2 Select "LIST", then highlight the message to be resent.
- 3 Press **[MSG]** again.
 - The input screen for the message appears with the destination call sign and the message content.
- 4 Press **[MENU]** to re-send the message.

■ Transmitting a Message

A message is sent up to a maximum of 5 times at 1 minute intervals, until an acknowledgment is received. No acknowledgment is returned for a bulletin, which is always sent 5 times at 1 minute intervals.

A message number is added to the end of the actual message. On the TH-D7, serial numbers from 0 to 9 are automatically added. The acknowledgment returned for a message also contains the message number. Accordingly, the TH-D7 that receives the acknowledgment can determine which message is being acknowledged. When it receives the acknowledgment data, the TH-D7 emits the acknowledgment arrived tone.

Note: When you receive rejection data in the procedure described in “Receiving a Message” (page 34), “rejn” (reject) is displayed (n represents a number). When the TH-D7 receives rejection data, it displays “rejn” and continues sending the message. If no acknowledgment is returned after 5 transmissions, transmission ends.

Some examples of the packet data in a message are shown below.

Example 1

Data sent in a message from WD6DJY to JA1YKX:

```
WD6DJY>APK001,RELAY,WIDE::JA1YKX :How are you?{3
```

- The data field starts with a colon (:) which is located directly in front of the call sign.
- The destination call sign field is fixed at 9 characters.
- “{3” indicates the message number.

Example 2

The acknowledgment returned for the above data:

```
JA1YKX>APK001,RELAY,WIDE::WD6DJY :ack3
```

- The data field starts with a colon (:) which is located directly in front of the call sign.
- The destination call sign field is fixed at 9 characters.
- The number after “ack” indicates the message number.



■ Receiving a Message

The TH-D7 can store up to 16 messages (transmitted/ received messages and bulletins) in its memory.

- **Mail Icon**

When the TH-D7 receives a new message, the mail icon appears on the bottom left of the display. The icon is not shown when you receive a bulletin. To clear the mail icon, press **[MSG]**, then select “LIST”. The icon is cleared even if you don’t read all of the unread messages. This icon denotes new message reception, not unread messages.

- **Pop-up Screen**

When the TH-D7 receives a message addressed to you, the pop-up screen appears. This screen shows the transmitting station call sign and the first 20 characters of the message. The TH-D7 also emits the new message notification tone and the display backlight is automatically lit.

The TH-D7 detects whether the address of the received message data matches the call sign you programmed in menu 2-1 (MY CALL). If the call signs do not match, the message will not be received. If the call sign matches but the SSID is different, the TH-D7 will receive the message, but it will not send an acknowledgment.

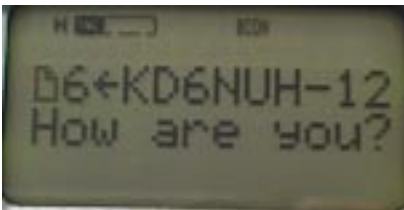

If an incoming message is exactly the same as a message you have already received, “dM” (duplicate message) appears on the bottom of the screen, along with the call sign of the sender.

If you receive message data addressed to another station, no pop-up screen is displayed. “oM” (other message) appears on the bottom of the screen.

- **Deleting Messages**

The TH-D7 automatically deletes stored data (transmitted/ received messages and bulletins) when a new message is received and when all 16 memory locations are full. The oldest stored data is deleted and the new data is stored. You cannot delete messages manually.

• Rejecting Messages

Under the following conditions, the TH-D7 will reject received messages and return them to the sender.

- ◆ All 16 memory locations are full,
- ◆ The mail icon is displayed, and
- ◆ The oldest data is a message that is addressed to you.

• Bulletins

When the TH-D7 receives a bulletin, the pop-up screen appears. This screen shows the transmitting station call sign and the first 20 characters of the bulletin. A tone does not sound and the backlight does not turn on.

■ Reading a Message

To read your messages, press **[MSG]** to display the message menu, select "LIST", then press **[OK]**. The most recent message appears. Press **[UP]** to scroll back through the stored data.

When you are reading your received messages and bulletins, pay close attention to the message and bulletin numbers, particularly bulletins, which can consist of multiple lines of text. Bulletin numbers are assigned to the respective bulletins, but they may not arrive in the correct order, depending on digipeater status. Data labeled 1, 2, and 3 may be received out of sequence (for example, they may be received as 1, 3, 2). Read them in the numbered order to ensure that the sentences flow as in the original data.

The message text is divided into 2 screens. The first screen shows the first 24 characters of the message, and the second screen shows the final 21 characters. Press **[ESC]** and **[OK]** to switch between the 2 screens.

The middle and bottom lines in the message list screen show the text of the message or bulletin. A left pointing triangle, as shown in the figure below and to the right, indicates the end of the message.

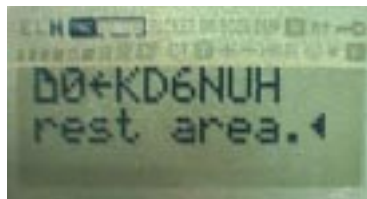
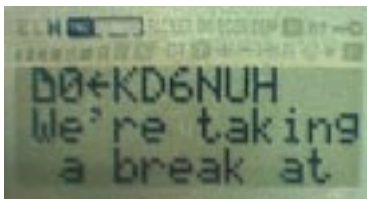

The top line in the message list screen varies, depending on the content of the data. The direction of the arrow indicates whether the displayed message is a received or transmitted message. The left arrow (←) indicates a received message. The right arrow (→) indicates a transmitted message.

1 Incoming messages

- The mail icon is displayed at the left end of the line.
- The last digit in the message number is displayed.
- The left arrow is displayed (received data).
- The call sign of the station that sent the message is displayed.

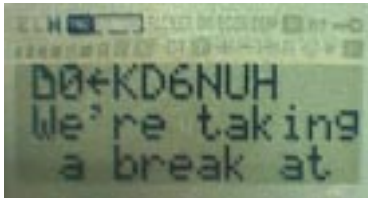

2 Incoming bulletins

- The last digit in the bulletin number is displayed at the left end of the line.
- The left arrow is displayed (received data).
- The call sign of the station that sent the bulletin is displayed.

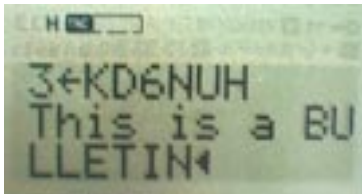

3 Outgoing messages

- The mail icon is displayed at the left end of the line.
- The right arrow is displayed (transmitted data).
- The call sign of the destination station is displayed.
- At the right end of the line, one of the following icons is displayed:
 - + Acknowledgment has not yet been received. The data is being sent at 1 minute intervals.
 - * Acknowledgment has been received. Transmission is completed.
- The data has been sent 5 times and no acknowledgment has been received.

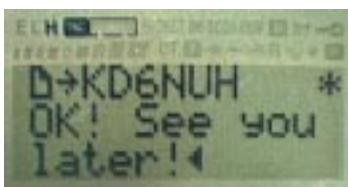

4 Outgoing bulletins

- The message icon is displayed at the left end of the line.
- The right arrow is displayed (transmitted data).
- “BLN” (bulletin) is displayed, followed by the bulletin number.
- At the right end of the line, one of the following icons is displayed:
 - + The data is being sent at 1 minute intervals.
 - The data has been sent 5 times.

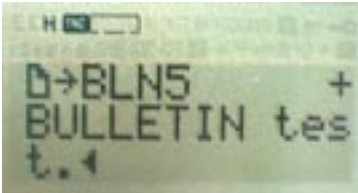

USING THE TH-D7 WITH A GPS RECEIVER

The TH-D7 has a GPS input port and can be easily connected to a GPS receiver. You can use the supplied cable to connect to the GPS receiver.

■ Enhancement

- The TH-D7 and GPS receiver with a built-in map is the most compact package for a mobile APRS station.
- Your current position, speed, and direction can be transmitted accurately. This allows other APRS stations to track you in real time.
- The TH-D7 can send waypoint packet data to the GPS receiver. GPS receivers with waypoint capability can display APRS station positions on the map.

In recent years, GPS receivers have become more affordable and a majority of current models meet the above specifications. We recommend that your GPS receiver support \$GPWPL sentence data input so you can use the waypoint function.

GPS receivers can be obtained through some radio shops, marine goods stores, outdoor goods stores, and large department stores. We recommend you do some research on the Internet or talk to local APRS stations before purchasing one.

■ Making the Cable

Use the cable supplied with the TH-D7, and connect it as shown below. Three (3) pins in the GPS receiver's data input/output terminal are used. If you do not use the waypoint function, only 2 pins are needed.

GND Signal Ground

TXD Data output

RXD Data input (used for the waypoint function)

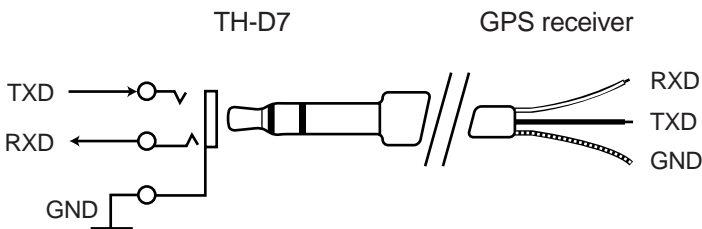

■ Receiving GPS Data

Connect the GPS receiver to the TH-D7 GPS input, then set menu 2-2 (GPS UNIT) to “NMEA”. We recommend you place the GPS receiver in an open location.

The TH-D7 receives position data from the GPS receiver every 10 seconds.

You can use one of the following methods to determine whether or not the GPS receiver is measuring your position.

- Check the GPS screen. The GPS screen displays your position in longitude and latitude.
- Press **[POS]** to display “My Position”. When the TH-D7 receives the measured GPS data, the minute units, “o”, and “.” blink.
- When the GPS receiver is not tracking your position accurately, the TH-D7 emits a tone every 10 seconds.
- After the GPS receiver accurately plots your position, the TH-D7 emits a short double-tone. This tone sounds only when the status changes from “Not measured” to “Measured”.

Note:

- ◆ *Do not send your APRS data when the GPS receiver has not accurately measured your position.*
- ◆ *Do not transmit your position data immediately after you switch the TH-D7 on and before GPS measurement, since your latitude and longitude at that point are 0. Wait until your position has been measured accurately.*
- ◆ *The position you entered in menu 2-3 (MY POSITION) is not used when you set menu 2-2 (GPS UNIT) to “NMEA”. While menu 2-2 (GPS UNIT) is set to “NMEA”, the TH-D7 uses the GPS position data that can be confirmed by pressing **[POS]**. You can copy this data to menu 2-3 (MY POSITION) as follows:*
 - 1 Press **[POS]** to display GPS.
 - 2 Press **[OK]** to display “COPYtoMENU?”.
 - 3 Press **[OK]** to complete the copy.



■ Waypoint Data Output

Waypoint originally referred to the way to a destination. This function is also used to leave a track of your path as you move towards your destination. The TH-D7 uses this function.

When the TH-D7 receives APRS position data, the call sign and position information are sent as waypoint data to the GPS receiver. The data is sent in the NMEA 0183 format \$GPWPL. By using a GPS receiver that supports \$GPWPL data input, the APRS station call sign and position received can be added to the waypoint list on the GPS receiver.

The call sign included in the waypoint data consists of a maximum of 6 characters. If more than 6 characters are used, only the last 6 will be displayed. See the examples below.

WD6DJY → WD6DJY

WD6DJY-1 → 6DJY-1

WD6DJY-12 → DJY-12

Note: Waypoint data is always output, even when you set menu 2-2 (GPS UNIT) to "NOT USED". If you do not want the waypoint data to be sent to the GPS receiver:

- Do not connect a line between the TXD output on the TH-D7 and the RXD input on the GPS receiver, or
- Set the GPS receiver input interface to a setting other than NMEA.



USING THE TH-D7 WITH A PERSONAL COMPUTER (AND GPS)

If you want to use the full range of APRS functions, connect the TH-D7 to a PC that has APRS software installed.

For mobile operation, connect a GPS receiver to the TH-D7.

■ System Configuration

- **Operating as a fixed station**

Connect the TH-D7 to your PC using the PG-4W cable.

- **Operating as a mobile station**

Connect the TH-D7 to your PC using the PG-4W cable.

Connect the GPS receiver to the TH-D7 using the cable provided with the TH-D7.

***Note:** Switch the battery saver function OFF to prevent the initial part of received data from being lost. If you are primarily transmitting APRS data, you do not need to switch the save function OFF.*

■ TH-D7 Setup

Connect the TH-D7 to the PC and set the TH-D7 to packet mode. Press **[TNC]** twice. (TNC and PACKET both appear on the screen.)



■ APRS Program Setup

As previously mentioned, setting the TH-D7 to packet mode sets it up for APRS operation using an APRS program on your computer. All that remains for you to do is set up the APRS program itself. Different APRS program packages operate in different ways, so refer to the Help and README files provided with the program.

- **Creating a TNC initialization file**

Most APRS software includes initialization files for different types of TNCs. These files are usually called "INIT****.TNC".

The "INITTHD7.TNC" file should be included. If it is missing, create a file as follows:

- 1 Start your text editor.
- 2 Enter the following text:

```
AWLEN 8
BBSMSGs ON
BEACON E 0
LOCATION E 0
ECHO OFF
FLOW OFF
AUTOLF OFF
MCOM OFF
MONITOR ON
MRPT ON
PACLEN 128
HBAUD 1200
GBAUD 4800
GPSTEXT $GPRMC
LTMH OFF
LTM 10
```

- 3 Save the file as "INITTHD7.TNC" in the same folder or directory used for the APRS software.

- **APRS program settings**

The results of tests conducted in February of 1999 is given below. Operation testing has not been conducted for some of the software, however, if you use the TNC initialization file given above, there should be no problems.

- APRSdos (version 830)
 - 1 Use the TNC initialization file for the TH-D7.
Press ALT-S, T, then enter INITTHD7.TNC and press ENTER.
 - 2 If you are using a GPS receiver, run the software in SPM (Single Port Mode).
Press ALT-S, G, M, then S. Next, register the validation number of the GPS function. Press ALT-S, then S.
- WinAPRS (version 2.2.6)
 - 1 Use the TNC initialization file for the TH-D7.
Click on Setting and Select TNC Type. Select Single TNC on VHF, then select INITTHD7.TNC as the TNC initialization file.
 - 2 Set up the serial port.
Click on Setting and select Serial Port, then select 9600, 8, 1, and NONE as the parameters.
 - 3 If you are using a GPS receiver, select Allow GPS in the VHF field in the current window.
- APRSplus (version 0.9.23)
 - 1 Use the TNC initialization file for the TH-D7.
Click on Setup and select INITTHD7.TNC.
 - 2 If you are using a GPS receiver, select Hardware Single Port mode.
Set the Port1 TNC mode to HSP.



REFERENCE MATERIALS

■ References

- The README file in the APRSdos software package.
- “Getting on Track With APRS” by Stan Horzepa, WA1LOU

■ Web Sites:

Bob Bruninga, WB4APR (APRSdos)
<http://web.usna.navy.mil/~bruninga/aprs.html>
<ftp://ftp.tapr.org/aprssi/dosstuff/APRSdos>

Brent Hildebrand, KH2Z (APRSplus)
<http://www.tapr.org/~kh2z/aprsplus>
<ftp://ftp.tapr.org/aprssi/winstuff/APRSPLUS>

Mark Sproul, KB2ICI (WinAPRS)
<http://msproul.rutgers.edu/KB2ICI.html>
<ftp://ftp.tapr.org/aprssi/winstuff/WinAPRS>

Keith Sproul, WU2Z (MacAPRS)
<http://dorm.rutgers.edu/~ksproul>
<ftp://ftp.tapr.org/aprssi/macstuff/MacAPRS>

Steve Dimse, K4HG (javAPRS, APRServe)
<http://www.aprs.net/steve.html>
<ftp://ftp.tapr.org/aprssi/javastuff>

Mike Musick, N0QBF (pocketAPRS)
<http://webusers.anet-stl.com/~mcmusick>
<ftp://ftp.tapr.org/aprssi/palmstuff/palmaprs>

PACKET COMMUNICATION

Packet communication is data communication using amateur radio.

Communication between personal computers and over the Internet is normally performed using telephone lines, but packet communication uses amateur radio to transmit and receive data.

Following is a brief discussion on what is possible using packet communication. More detailed explanations can be found in amateur radio magazines, and technical publications, as well as on the Internet.

Chat: Conversations that use keyboards and personal computers instead of voice.

E-mail: Mail written on a computer and sent via packet communication. E-mail is also a function provided by RBBS.

The TH-D7 TNC does not provide RBBS, but you can still write mail to other stations.

RBBS: The RBBS (Radio Bulletin Board System) is a system in which any kind of information can be posted on an electronic bulletin board and then read by other users.

Some RBBSs are transfer type bulletin boards, in which posted information is automatically transferred to other RBBSs. Mail can be transferred in the same way.

Satellite Communications: Some amateur communications satellites have a digital mode and can be used in packet communication. Refer to technical publications for details.

Some people say they have used a TH-D7 to receive PACSAT data.

Transfer of Position Data: Packet communication can be used to exchange position data. This is called Navitra in Japan and APRS in the U.S.A.. While a TH-D7 alone can be used to access Navitra and APRS, using the TH-D7 with a personal computer allows you to view your position, as well as other users' relative positions and messages, on a map. You can also use the Internet to check position data.

Using Relay Stations (Digipeaters): In packet communication, digipeaters are used for data communication with stations that are out of range of direct radio signals.

The TH-D7 TNC cannot be used as a digipeater, but it can readily access them.

High-speed Data Communication: Most packet communication is conducted at 1200 bps. The TH-D7 is capable of high-speed communication (9600 bps).

Members of some amateur radio groups are researching ways of achieving even faster data communication.



DX Clusters: Some DX clusters use packet networks. DX clusters comprise of a network in which packet communication is used to send DX data.

DX data includes information such as the station call sign, transmit frequency, and comments. Some Internet sites generate DX data.

The TH-D7 can monitor a DX cluster without being connected to a personal computer. The information displayed is the station call sign, the frequency, and any comment. Up to 10 stations can be displayed. When data is received from an 11th station, the oldest data is cleared.

The TH-D7 has its own built-in TNC, making it even easier to use packet communication.

CONNECTION AND SETUP

■ Setting Up the TH-D7

Set up the TH-D7 as follows:

- 1 Data Band (menu 1-4-1): Select the band (A or B) to be used for data communication.
- 2 DCD SENSE (menu 1-4-2): Select the TNC busy detection method.
 - For concurrent packet and voice communication, select BOTH BANDS.
 - For packet communication only, select Data BAND ONLY.
- 3 SAVE (menu 1-2-1): Set to OFF. (Data cannot be received while the Save function is ON.)
- 4 APO (menu 1-2-2): Set to OFF. (You only occasionally touch the transceiver in packet communication.)

Note: When the TH-D7 is used with SAVE and APO set to OFF, the battery charge is depleted more rapidly. Do not forget to switch the transceiver off when Automatic Power Off is not used!

To select packet mode, press **[TNC]** twice.

- “TNC” and “PACKET” appear on the display.



■ Setting Up the PC

Specify the following communication settings on the PC:

Data transfer speed: 9600 bps
 Data bits: 8 bits
 Parity bits: None
 Stop bits: 1 bit
 Flow control: Xon/Xoff

TNC CONFIGURATION AND SPECIFICATIONS

■ Configuration

The three major components are:

- TNC control CPU
- Packet data encode/decode IC
- External filter, comparator, etc.

The external components (PC and GPS receiver) are connected to the PC and GPS jacks on the side of the TH-D7 via an RS-232C level converter. This allows you to connect the PC and GPS together.

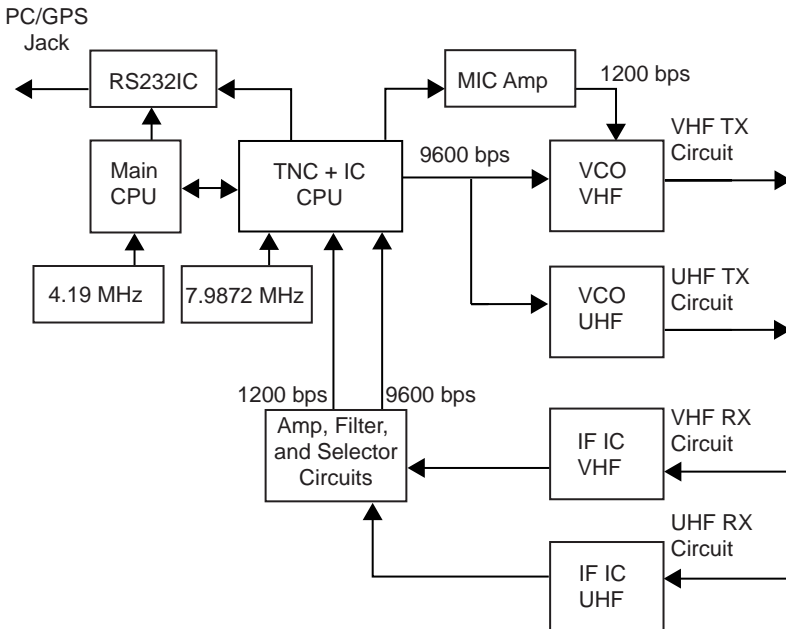

■ Specifications

• Packet

	1200 bps	9600 bps
Modulation	AFSK	GMSK
Protocol	AX.25 protocol-compliant	←
Frequency deviation	±500 Hz	
Subcarrier frequency	1700 Hz	—

• PC/GPS Jack

	PC	GPS (NMEA)	GPS (IPS)
Transmission speed	9600 bps	4800 bps	9600 bps
Data bits	8 bits	8 bits	8 bits
Stop bits	1 bit	1 bit	1 bit
Parity	None	None	None
Flow control	Software	None	None

PRECAUTIONS AND RESTRICTIONS FOR PACKET OPERATIONS

- The TNC was designed to fit inside the TH-D7 transceiver, therefore not as many functions and commands are available on it as there are on commercially available TNCs.

For example, it has no message board function and cannot be used as a digipeater.

- The TNC does not back up TNC settings. You can only backup the call sign onto the transceiver.
- The TNC is initialized by using the RESET command. However, when you use RESET, the stored MYCALL setting is also reset to the TNC default so you must set up MYCALL again. To avoid this, you can restart the TNC by turning the power OFF and then back ON rather than using RESET.
- The TH-D7 may pick up noise from the PC. Keep the transceiver as far away from noise sources as possible.
- When you switch the TNC ON, it may emit an internal beat. If this occurs, set the beat shift as described in the instruction manual.

The beat is emitted when the TNC oscillation harmonic is close to the reception frequency. The reception frequency is approximately $7.9872 \text{ MHz} \times N$ (where $N = 18, 54, 55, 56, \text{etc.}$)

- When packet communication fails, check the following:
 - ◆ Is the PC connected correctly?
 - ◆ Are the PC and TH-D7 connected correctly?
 - ◆ Are you using packet mode?
 - ◆ Is the squelch open? (Check the DCD SENSE setting.)
 - ◆ Is the correct packet communication speed selected?



TNC OPERATION MODES

The TNC can operate in two modes: Command mode and Converse mode.

- **Command Mode**

The TNC normally operates in Command mode.

In Command mode, the “cmd:” prompt is displayed. The prompt may not be visible when operation is being monitored, but pressing ENTER (or RETURN) causes the prompt to reappear.

- **Converse mode**

This mode is used to transmit keyed-in data as packets.

To switch to Converse mode from Command mode, issue the CONVERSE, CONV, or K command. Receiving another station will automatically switch operation to Converse mode.

To switch from Converse mode back to Command mode, hold down the Ctrl key and press C.

Always specify MYCALL before sending data.

TNC STATUS DISPLAY AND COMMANDS

The TNC operation status is displayed on the TH-D7 LCD screen and LEDs.

- **TNC icon**
Appears while the TNC is active.
- **PACKET icon**
Appears while in packet mode.
- **CONNECT icon**
Appears while the TH-D7 is in the process of connecting to a station. Goes OFF when disconnected.
- **STA icon**
Appears while RAM holds the data that is to be sent.
- **Busy LED**
Lights green when a signal is detected. Packets cannot be sent when this LED is lit.
- **TX LED**
Lights red during transmission.

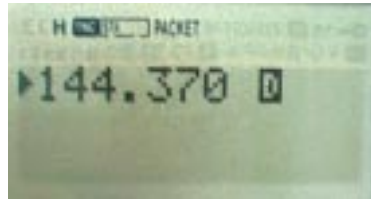
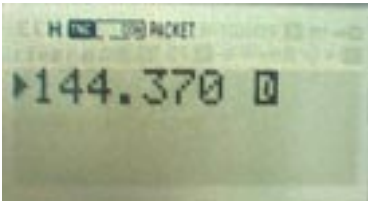

LEDs may light in special patterns, depending on the command status.

- **HEALLED**
Short form: HEAL Default: OFF Parameters: ON or OFF
Example: AW 8

Function: Flashes the LCD icons to indicate whether the firmware is operating normally or if it is malfunctioning.

ON: CON and STA alternate flashing. If the TNC is not functioning normally, this flashing cannot be performed.

OFF: The display functions normally.

COMMANDS

Command name	Short form	Default	Parameters	Description
AUTOLF	AU	ON	ON/ OFF	Sends a line feed (LF) to the PC after each carriage return (CR).
AWLEN	AW	8	7/8	The number of data bits between the TNC and host can be set to 7 or 8. The TH-D7 must be set to 8 bits.
BBSMSGS	BBS	OFF	ON/ OFF	Changes the message output by the TNC.
BEACON	B	EVERY 0	EVERY/ AFTER n (0 ~ 250)	Sets the beacon transmission interval in units of 10 seconds.
BTEXT	BT	–	159 characters	Enters the character string transmitted as the beacon.
CALIBRAT	CAL	–	–	Sends a space/mark square wave (50:50 ratio). Press Q to exit Calibrate mode.
CHECK	CH	30	0 ~ 250	Sets the interval between packet signal dropout and checking/disconnection in units of 10 seconds.
CMSG	CMS	OFF	ON/ OFF	Specifies whether or not CTEXT is automatically sent when a connection is made.
CMSGDISC	CMSGD	OFF	ON/ OFF	Specifies whether or not the TNC is automatically disconnected when a connection is made.
CONNECT	C	–	Call (VIA call1, call2,, call8)	Sends a connect request. (Call signs after VIA are for digipeaters.)
CONOK	CONO	ON	ON/ OFF	Accepts or rejects a connection request from another station.

Command name	Short form	Default	Parameters	Description
CONVERSE	CONV; K	–	–	Switches the TNC to Converse mode.
CPACTIME	CP	OFF	ON/ OFF	Enables and disables PACTIME in Converse mode also.
CR	CR	ON	ON/ OFF	Specifies whether a carriage return (CR) is added to sent packets.
CTEXT	CT	–	159 characters	Specifies the content of a message to be sent when a connection is made. CTEXT is also used by LTEXT.
DISCONN	D	–	–	Sends a disconnect request.
DISPLAY	DISP	–	Class specification characters (A, C, H, I, L, M, T)	Displays the command status.
DWAIT	DW	30	0 ~ 250	Specifies the interval between the channel being cleared and the PTT switching ON.
ECHO	E	ON	ON/ OFF	Switches echo back ON and OFF.
FIRMRNR	FIR	OFF	ON/ OFF	When an RNR frame is received, this command specifies whether to resend or not send before the next frame is received.
FLOW	F	ON	ON/ OFF	When ON, suppresses the display of received packets when key entry starts.
FRACK	FR	3	0 ~ 250	Sets the interval between a transmission and the retry of that transmission in units of 1 second.

Command name	Short form	Default	Parameters	Description
GBAUD	GB	4800	4800/ 9600	Selects the transmission speed between the TNC and the GPS receiver.
GPSMON	GPSMON	OFF	ON/ OFF	Sends the incoming GPS data input to the COM port.
GPSEND	GPSS	–	159 characters	Sends a character string to the GPS receiver. This string is used to set the GPS default setting and is not stored in memory.
GPSTEXT	GPST	\$PNTS	6 characters	Specifies the type of the GPS information message set by LTEXT.
HBAUD	HB	1200	1200/ 9600	Sets the communication speed.
HEALLED	HEAL	OFF	ON/ OFF	Tests the TNC operation
LOC10X	LOC10X	ON	ON/ OFF	Sets up the location time units (10 s/ 1 s)
LOCATION	LOC	EVERY 0	EVERY/ AFTER n (0 ~ 255)	Sets the interval for GPS data transmission in units of 10 seconds.
LOOP	LOOP	OFF	ON/ OFF	Loops back the transmitted contents of the TNC, or the status remains normal.
LPATH	LPA	GPS	Call (VIA call1, call2,, call8)	Sets the destination for GPS data, including the digipeater path.
LTEXT	LT	–	159 characters	Specifies the content of a message used to send GPS data.
LTMON	LTM	0	0 ~ 256	Specifies the intervals at which the content of an LTEXT message is displayed on the computer in exactly the same way as a received beacon.

Packet Communication

Command name	Short form	Default	Parameters	Description
LTMHEAD	LTMH	ON	ON/ OFF	Specifies whether a header is attached to the screen display generated by LTMON.
MALL	MA	ON	ON/ OFF	Monitors all stations (ON) or only unconnected stations (OFF).
MAXFRAME	MAX	4	1 ~ 7	Sets the maximum number of packets that can be sent at one time.
MCOM	MCOM	OFF	ON/ OFF	Specifies whether all frames are monitored or only information frames.
MCON	MC	OFF	ON/ OFF	Specifies whether or not to monitor other stations when connected.
MONITOR	M	ON	ON/ OFF	Specifies whether or not packet communication is monitored.
MRPT	MR	ON	ON/ OFF	Specifies whether or not the TNC includes the digipeater path in the header.
MYCALL	MY	NOCALL	6 characters + SSID	Sets your call sign.
NTSGRP	NTSGRP	000	3 alphanumeric characters	Specifies the group code added to Navitra ¹ GPS data.
NTSMRK	NTSMRK	0	0 ~ 14	Specifies the icon used in Navitra ¹ GPS data.
NTSMMSG	NTSMMSG	–	20 characters	Specifies the message added to the Navitra ¹ GPS data.
PACLEN	P	128	0 ~ 255	Sets the maximum length of the data component of a packet.

Packet Communication

Command name	Short form	Default	Parameters	Description
PACTIME	PACT	AFTER 10	EVERY/ AFTER n (0 ~ 255)	Sets the time interval for the automatic transmission of packets in units of 100 milliseconds.
PARITY	PAR	0	0 ~ 3	Sets the method for checking the parity.
PASSALL	PASSA	OFF	ON/ OFF	Specifies whether or not the TNC receives packets that contain errors.
PERSIST	PE	127	0 ~ 255	Sets the probability for the P-persistent CSMA protocol.
PPERSIST	PP	ON	ON/ OFF	Specifies whether or not the P-persistent CSMA protocol is used.
PORTOUT	PORTO	\$0000	\$0000 ~ \$07FF	Specifies an extension output board.
RESET	RESET	–	–	Restores the default settings. Backup parameters are also reset.
RESPTIME	RES	5	0 ~ 250	Specifies the acknowledgment packet transmission delay in units of 100 milliseconds.
RESTART	RESTART	–	–	Has the same effect as switching the TNC OFF and then ON again.
RETRY	RE	10	0 ~ 15	Specifies the number of transmission retries.
RXBLOCK	RX	OFF	ON/ OFF	Specifies whether or not the discrimination block adheres to the received packet.
SENDPAC	SE	\$0D	0 ~ \$7F	Sets the character code that sends packets.

Packet Communication

Command name	Short form	Default	Parameters	Description
SLOTTIME	SL	3	0 ~ 250	Specifies the time interval for random number generation in the P-persistent CSMA protocol.
SOFTDCD	SOFTDCD	OFF	ON/ OFF	Sets the DCD detection to either “soft” detection or “hard” detection.
TRACE	TRAC	OFF	ON/ OFF	Specifies whether all or only some of the frames in a message are displayed.
TRIES	TRI	0	0 ~ 15	Changes the setting of the retry counter.
TXDELAY	TX	30	0 ~ 120	Sets the time delay between PTT ON and the start of data transmission in units of 10 milliseconds.
TXUIFRAM	TXU	ON	ON/ OFF	Specifies whether or not Unportocol Packet is transmitted.
UNPROTO	U	CQ	Call (VIA call1, call2,, call8)	Specifies the packet destination and digipeater path when no connection has been made.
XFLOW	X	ON	ON/ OFF	Selects either software flow control (ON) or hardware flow control (OFF).
XMITOK	XM	ON	ON/ OFF	Permits (ON) or prohibits (OFF) packet transmission.

1 NAVITRA (Navigation Transceiver) is a system used in Japan to indicate the positioning of each party. Data, such as latitude, longitude, time, mobile speed, direction, etc., transferred from a GPS receiver is converted into the data for NAVITRA, and is transmitted from a transceiver at certain intervals. This is in accordance to the AX.25 packet communications protocol. The main operating band is 431.000 MHz.

Like APRS, NAVITRA uses a system consisting of a transceiver, TNC, PC, and GPS. NAVITRA can also use a system consisting of a transceiver, TNC, and Car navigation system.



COMMAND DESCRIPTIONS (BY USAGE)

■ TNC to PC

- **Related Commands**

1 AWLEN

Short form: AW Default: 8 Parameters: 7 or 8
 Example: AW 8

Function: Sets the data bits used in serial communication between the TNC and the host computer.

Select “7” for 7 bits and “8” for 8 bits. (The TH-D7 must be set to 8 bits.)

After changing the command setting, use the RESTART command to activate it.

2 ECHO

Short form: E Default: ON Parameters: ON or OFF
 Example: ECHO OFF

Function: Specifies whether or not characters typed from the PC are echoed back.

ON: Characters are echoed.

OFF: Characters are not echoed.

This corresponds to the local echo setting in the terminal software. If the data communication is not consistent, typed characters may be displayed two times or not at all.

3 FLOW

Short form: F Default: ON Parameters: ON or OFF
 Example: F ON

Function: When FLOW is ON, the PC temporarily stops displaying received packets while typing. When typing ends (when the ENTER key is pressed in Command mode, or when the packet is sent in Converse mode), packet display resumes. Received and typed characters are separated in order to distinguish them from each other. If the TNC buffer memory fills up while incoming packet display is paused, subsequent incoming packets are discarded.

4 XFLOW

Short form: X Default: ON Parameters: ON or OFF
Example: XFLOW OFF

Function: Specifies whether or not software flow control is enabled.

When this parameter is ON, software flow control is enabled. The XOFF code (Ctrl + S) pauses serial data transfer and the XON code (Ctrl + Q) restarts it.

When XFLOW is OFF, software flow control is disabled. For the TH-D7, set the flow control to ON. The TH-D7 does not support hardware flow control.

5 AUTOLF

Short form: AU Default: ON Parameters: ON or OFF
Example: AU ON

Function: Specifies whether or not an LF code is added after each CR code when character codes such as incoming packet displays are sent from the TNC to the host PC.

ON: The LF code is added after each CR code.

OFF: No LF code is added after each CR code.

This corresponds to the “[CR]/[CR]+[LF] at [CR] reception” setting on the terminal software. If data communication is consistent, received packets are displayed on one line without line feeds, or they will have a blank line inserted after each line of text.

6 PARITY

Short form: PAR Default: 0 Parameters: 0 ~ 3
Example: PAR 0

Function: Sets up the parity of the serial port with the host computer.

0 & 2: non parity

1: Odd-numbered parity

3: Even-numbered parity

If PARITY is changed, the communication conditions will not change. Use RESTART to restart the system.

In the TH-D7, you must select non parity. Setting odd- or even-numbered parity may cause abnormal operation.

■ Communication Commands

- **Basic commands for transmission and reception**

1 HBAUD

Short form: HB Default: 1200 Parameters: 1200 or 9600
 Examples: HBAUD 9600 or HB 1200

Function: Sets the data transfer speed between packet stations.

1200: Allows AFSK 1200 bps communication.

9600: Allows GMSK 9600 bps communication.

2 MYCALL

Short form: MY Default: NOCALL
 Parameters: 6 alphanumeric characters and the SSID
 Example: MY JN1YKX-15

Function: Sets your call sign (ID).

Normally, a call sign consists of up to 6 alphanumeric characters. However, by adding an SSID (Substation ID) to the call sign, one of 16 identification codes can also be used. To specify an SSID, place a hyphen (-) after the call sign and add a number from 0 ~ 15.

3 XMITOK

Short form: XM Default: ON Parameters: ON or OFF
 Example: XMITOK ON

Function: Specifies whether or not the PTT is set to ON.

ON: PTT is ON when data is transmitted (normal setting).

OFF: PTT remains OFF and no data is sent.

4 CALIBRAT

Short form: CAL Default: – Parameters: –
 Example: CAL

Function: Alternately outputs a space/mark square wave (50:50 ratio).

To return to Command mode, type Q. Transmission does not stop when you execute this command. To send data, apply a dummy load to the ANT jack, then transmit.

5 LOOP

Short form: LOOP Default: OFF Parameters: ON or OFF

Example: LOOP ON

Function: When this parameter is ON, it performs a loop back test. The loop back is made internally in the TNC so you can monitor your own transmitted data.

During the loop back test, you cannot transmit from your transceiver. Also, you cannot monitor received signals.

When LOOP is OFF, normal operation is performed.

- **Transmission commands**

This section explains the PPERSIST, PERSIST, SLOTTIME, and DWAIT commands. These are used to minimize the conflict of packets. Also explained is the TXDELAY command used for timing transmissions.

Because these commands are interrelated, refer to the explanations of the related commands. Simple diagrams are used to illustrate the timing relationships.

1) When PPERSIST is set to OFF:

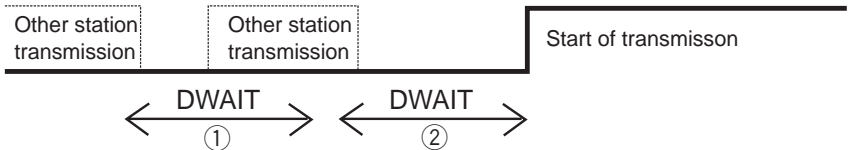

① When squelch is closed, the DWAIT count begins. If squelch is open during the count, the count stops and the TNC does not start to transmit.

② When squelch closes, the DWAIT count restarts. If squelch is not open during the count, the TNC transmits.



2) When PERSIST is set to ON (default):

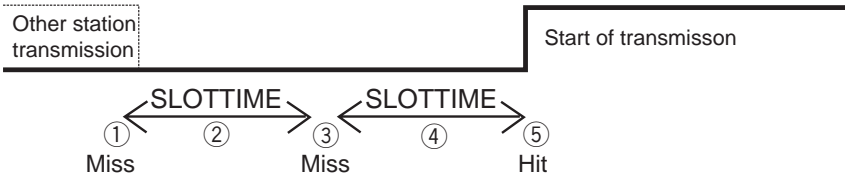

- ① When the transmission from the other station ends (not busy), a random number from 0 ~ 255 is generated. If that number is greater than the PERSIST number, a “miss” occurs and the TNC does not transmit.
- ② When a “miss” occurs, the TNC waits for the SLOTTIME time and then generates another random number.
- ③ If the new number is greater than the PERSIST number, another “miss” occurs.
- ④ The TNC again waits for the SLOTTIME time and then generates another random number.
- ⑤ If the new number is less than the PERSIST number, a “hit” occurs and transmission begins.

If another station transmits (busy) during the SLOTTIME waiting period, the count is aborted. A random number is generated when the channel becomes free.

3) TX delay time:

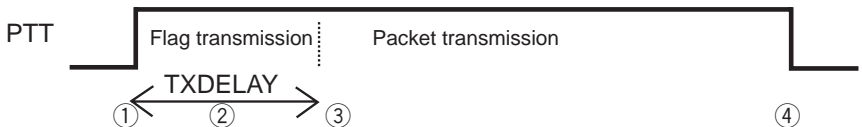

- ① PTT is switched ON and transmission of the flag begins. The flag indicates the packet delimiters and synchronizes the data clock.
- ② The TNC waits for the TXDELAY interval. This interval must include the TX attack time (the time from RX to TX) and enough time for the receiving station to receive the flag. If the receiving station is using a battery saver function, the transceiver will need some “wake-up” time. (We recommend you do not use the Save function.)
- ③ After the TXDELAY, send the packet.
- ④ When transmission ends, PTT is switched off.

1 PERSIST

Short form: PP Default: ON Parameters: ON or OFF
Example: PP ON

Function: Specifies whether the P-persistent CSMA protocol is used.

ON: P-persistent CSMA is used. If a carrier is not detected and the channel is free, the PERSIST probability is used to determine whether or not the data will be sent. If the result is positive, the data is sent. If it is negative, the TNC waits for the SLOTTIME time and then tries again. This is an effective way to reduce the traffic when a channel becomes free. Without this, all stations would transmit as soon as the channel is free.

OFF: The ordinary carrier wave detection method (Non-persistent CSMA) is used. Transmission begins when the channel has been free (a carrier is not detected) for the DWAIT interval.

2 PERSIST

Short form: PE Default: 127 Parameters: 0 ~ 255
Example: PERSIST 63

Function: Sets the probability of a positive result when P-persistent CSMA is used.

PERSIST uses the principle of drawing lots to determine the time of a transmission. A random number from 0 ~ 255 is generated and if it is equal to or less than the specified value, the result is positive. If the number is greater than the set value, the result is negative.

If the specified value is too high, the conflict of packets will increase. If it is too low, the data may not be sent even when the channel is free.

3 SLOTTIME

Short form: SL Default: 3 Parameters: 0 ~ 255
Example: SL 5

Function: If the P-persistent CSMA protocol produces a negative result, SLOTTIME specifies the delay (in units of 10 milliseconds) until the next random number is generated.

4 DWAIT

Short form: DW Default: 30 Parameters: 0 ~ 255
Example: DWAIT 10

Function: In the Non persistent CSMA protocol (when PERSIST is set to OFF), transmission starts when the DWAIT interval has passed.

When multiple stations are using the same channel, each station sets a different DWAIT setting to minimize the conflict of packets.

5 TXDELAY

Short form: TX Default: 50 Parameters: 0 ~ 255
Example: TX 80

Function: Sets the time delay from PTT ON to the start of transmission. The delay is specified in units of 10 milliseconds. The flag data is sent during this interval. The flag indicates the packet delimiters and it synchronizes the data clock.

TXDELAY must include:

- TX attack time: The time from RX to TX.
- Receiving time: Receiving station must receive the transmitted flag.
- Wake up time: If the transceiver at the receiving station is using a battery saver function, the transceiver will need some “wake-up” time. (We recommend you do not use the Battery Save function.)

6 SOFTDCD

Short form: SOFTDCD Default: OFF Parameters: ON or OFF
Example: SOFTDCD ON

Function: Sets up a detection mode to detect the availability of the carrier frequency (whether or not other stations are transmitting).

ON: Software detect - If a received signal contains data, it is recognized as a busy channel.

OFF: Hardware detect - The transceiver is busy.

• Reception commands

1 PASSALL

Short form: PASSA Default: OFF Parameters: ON or OFF
Example: PASSALL ON

Function: In the AX.25 protocol, the CRC code is used to check for errors in incoming frames. PASSALL determines how frames with errors are handled.

ON: Frames with errors are accepted.

OFF: Frames with errors are not accepted. Error-free data transfer can be achieved when set to OFF (normal operation).

- **Commands for connecting and communicating with the other party**

1 CONNECT

Short form: C Default: –
 Parameters: Destination call sign VIA digipeater 1, digipeater 2 ... digipeater 8
 Examples: C WD6DJY-1 ; C WD6DJY-1 VIA KF6OSG-2 ; and C WD6DJY-1 V KF6OSG-2, KF6OSH-1

Function: Sends a connection request frame (SABM frame) to the specified station you want to communicate with. When a confirmation frame (UA frame) is received, “***CONNECTED to destination-call-sign and digipeaters” appears and the connection is made. If no confirmation frame is received, it resends the connection request frame. After the stipulated number of retries, the connection times out.

This “confirmation data transfer” between the two stations uses the AX.25 protocol. These procedures allow error-free data transfer.

The “destination call sign” field specifies the call sign of the station you want to contact. The first of the examples given above shows an attempt to connect to WD6DJY-1 (the SSID is also specified).

If your signal cannot reach the other party directly, your connection can be relayed via digipeaters. Specify VIA (or V) after the destination call sign followed by a maximum of 8 digipeater stations, in order.

In the last example given above, your data hops as shown below.

You → KF6OSG-2 → KF6OSH-1 → Destination (WD6DJY-1)
 You ← KF6OSG-2 ← KF6OSH-1 ← Destination (WD6DJY-1)

For more information about frames, refer to the AX.25 Protocol Specifications or the Packet Communication Handbook.

2 DISCONN

Short form: D Default: – Parameters: –
 Example: D

Function: Sends a disconnect request frame (DISC frame) to the station you are connected with. When you receive a confirmation frame from the other party, “***DISCONNECTED” appears and you are disconnected.

3 CMSG

Short form: CMS Default: OFF Parameters: ON or OFF
Example: CMSG ON

Function: When set to ON and a connection is made, a message is automatically sent to the destination. The content of the message is specified by CTEXT.

When set to OFF, a message is not automatically sent.

4 CTEXT

Short form: CT Default: – Parameters: Up to 159 characters
Example: CT I'M OUT. CATCH YOU LATER.

Function: When CMSG is ON and a connection is made, the characters set by this command are sent automatically.

On the TH-D7 TNC, the CTEXT and LTEXT messages are the same. When you set the LTEXT message, the CTEXT message also changes. When a GPS receiver is connected to the transceiver, the LTEXT message is automatically updated, thus the CTEXT message also changes.

5 CMSGDISC

Short form: CMSGD Default: OFF Parameters: ON or OFF
Example: CMSGD ON

Function: This command is enabled only when CMSG is ON. If CMSG is OFF, this command is ignored.

ON: Automatically disconnects after a connection has been made and the CTEXT message has been sent.

OFF: Does not automatically disconnect.



6 RESPTIME

Short form: RES Default: 5 Parameters: 0 ~ 250
 Example: RES 5

Function: When an information frame (I frame) is successfully received from a connected station, a confirmation frame must be returned. A reply is not sent as soon as an information frame is received. By delaying the reply, one reply can be sent for a group of information frames received consecutively. One reply can be used to confirm up to 7 frames. This allows fewer confirmation frames to be sent when consecutive information frames are sent as a file.

RESPTIME specifies the delay between an information frame being received and the reply being returned. The delay is set in units of 100 milliseconds.

A large value increases the time until a reply is sent. It may deteriorate on the quality of data transfer. If you set a value too large, information frames may be resent before you send a reply.

7 FRACK

Short form: FR Default: 3 Parameters: 0 ~ 250
 Example: FR 5

Function: You should receive a confirmation frame from the connected station when the information frame (I frame) you sent arrives successfully. If no reply arrives after a set period of time, the system assumes the transmission failed and the I frame is sent again. Replies are also expected for other frames, such as connection request (SABM) frames. If no response is received when these frames are sent, they are also sent again.

This command specifies the interval time (in seconds) for resending a frame.

When the connection is made using digipeaters, the interval is automatically set as follows: $(\text{Hopped digipeaters} \times 2 + 1) \times \text{FRACK value}$. When a digipeater relays a packet, it does not send a reply. The time required for the transmitted packet to reach its destination and for a reply to be returned is equivalent to the number of digipeater hops multiplied by 2. The TH-D7 automatically changes the interval time according to the number of digipeaters.

If the channel is busy and the station is unable to send a reply, the frame may be resent. This adds even more traffic to a crowded channel. Set a slightly larger FRACK value to avoid this.

8 RETRY

Short form: RE Default: 10 Parameters: 0 ~ 15
 Example: RE 15

Function: If there is no reply from the station after the time specified in FRACK, the frame is resent.

RETRY sets the maximum number of retries.

When the retry count exceeds the RETRY value, “*** retry count exceeded” and “*** DISCONNECTED” are displayed. The connection is cut. Under the original AX.25 protocol, a connection request frame (SABM frame) will be sent. TNCs are provided with a RELINK command to send the reconnection request stipulated in the AX.25 protocol. The TH-D7 RELINK command is set to ON and cannot be changed.

9 TRIES

Short form: TRI Default: 0 Parameters: 0 ~ 15
 Example: TRI 0

Function: Resets or checks the current RETRY count.

10 CHECK

Short form: CH Default: 30 Parameters: 0 ~ 250
 Example: CH 12

Function: While you are connected but no data transfer is in progress, CHECK sends a query to the connected station to check whether or not they are on standby.

After packet transmission from the connected station stops, the transceiver waits for the CHECK time before sending a check packet. The time is specified in units of 10 seconds.

11 FIRMRNR

Short form: FIR Default: OFF Parameters: ON or OFF
 Example: FIR ON

Function: When the connected station sends you an RNR frame indicating they are not ready to receive and would like you to wait before sending any data, FIRMRNR specifies whether or not you send a packet anyway.

ON: When you receive an RNR frame, no packets are sent until you receive the next frame from the other party.

OFF: Packets are sent regardless of whether or not the other party is able to receive data. This may result in the transmission of packets that are unlikely to be received, resulting in less efficient channel use.

12 CONOK

Short form: CONO Default: ON Parameters: ON or OFF
Example: CONOK ON

Function: When this parameter is ON, the Connection Request is responded to. After receiving the Connection Request (SABM) frame from the other station, an Acknowledgement (UA) frame is sent back to the station of origin.

When CONOK is OFF, the Connection Request is not responded to. After receiving the SABM frame from the other station, a Disconnection Mode (DM) frame is returned.

- **Commands when not connected to another party**

When you communicate without connecting to another party, the packet is sent to unspecified stations. Packets with errors are simply discarded by the receiving stations so no resend requests are issued. Also, the sending station sends continuously and so does not perform any resends. 100% error-free transmission cannot be guaranteed. Use this communication mode when you are chatting with many people at the same time, when you want to send a message to multiple unspecified stations, or when you are sending GPS position data.

1 TXUIFRAM

Short form: TXU Default: ON Parameters: ON or OFF
Example: TXU ON

Function: Specifies whether or not Unprotocol packets (packets sent while unconnected) other than beacons can be sent.

ON: Unprotocol packets are sent.

OFF: Unprotocol packets are not sent.

If you are disconnected while you are sending files, the remaining files can still be sent as unprotocol files. The files are sent as a continuous stream and the channel becomes overcrowded. This can be avoided by setting TXUIFRAM to OFF.

2 UNPROTO

Short form: U Default: CQ
Parameters: Destination call sign VIA digipeater 1, digipeater 2 ... digipeater 8
Examples: U GPS ; and U CQ V JA1YKX

Function: Sets the call sign and the digipeaters when a packet is sent without first making a connection.

3 BEACON

Short form: B Default: EVERY 0
Parameters: EVERY (E) or AFTER (A) 0 ~ 250
Example: B E 6

Function: Sets the timing of beacon transmission.

EVERY: The beacon packet is sent at intervals of the specified periods.

AFTER: The beacon packet is sent only once after the specified periods.

When 0 is specified, no beacon is sent.

A value between 1 and 250 (in units of 10 seconds) sets the interval.

4 BTEXT

Short form: BT Default: –
Parameters: Up to 159 characters
Example: BT This is the beacon message.

Function: Specifies the data transmitted as a beacon. A character string of up to 159 characters can be specified.

If BTEXT is blank, the beacon is not transmitted.

To clear the BTEXT message, use BT %.

• **Commands that control how packets are generated**

Text entered in Converse mode is transmitted as packets. These commands specify how these packets are generated.

When the text entered in Converse mode meets any of the conditions given below, the text entered up to that point is collected into one information frame (I frame).

- ◆ A specific character code is entered; SENDPAC and the related CR command.
- ◆ A specified length is reached; PACLEN.
- ◆ A specified time has passed; PACTIME and the related CPACTIME command.

Multiple frames can be collected into one transmission. MAXFRAME determines the maximum number of frames.

1 SENDPAC

Short form: SE Default: \$0D Parameters: 0 ~ \$7F
Example: SENDPAC \$0D

Function: In Converse mode, when the character code specified in SENDPAC is entered, the text entered up to that point is collected into an I frame and transmitted.

The default setting is [CR].

The character code specified in SENDPAC is not included in the I frame.

2 CR

Short form: CR Default: ON Parameters: ON or OFF
Example: CR ON

Function: Specifies whether or not the [CR] code is added to the end of each transmitted packet.

ON: Added

OFF: Not added

Normally, no [CR] code is inserted when the I frame is generated because the SENDPAC command string is \$0D (which is the CR code). However, when the CR command is ON, a [CR] code is added to the end of each I frame.

3 PACLEN

Short form: P Default: 128 Parameters: 0 ~ 255
Example: P 78

Function: When the entered character text reaches the specified PACLEN value (in bytes), they are collected into an I frame.

4 PACTIME

Short form: PACT Default: AFTER 10
Parameters: EVERY (E) or AFTER (A) 0 ~ 250
Example: PACT A 10

Function: When CPACTIME is ON, it is enabled in Converse mode.

EVERY: An I frame is assembled every time the interval specified has elapsed. If no characters have been entered during an interval, the frame is not sent.

AFTER: An I frame is assembled when there has been no keyed input for the interval specified.

The entered number specifies the time used in units of 100 milliseconds.

5 CPACTIME

Short form: CP Default: OFF Parameters: ON or OFF
Example: CP OFF

Function: Specifies whether or not PACTIME is enabled in Converse mode.

ON: PACTIME is enabled in Converse mode.

OFF: PACTIME is disabled in Converse mode.

6 MAXFRAME

Short form: MAX Default: 4 Parameters: 1 ~ 7
Example: MAX 7

Function: When data is transmitted, a number of frames queued for sending are collected into one packet. MAXFRAME specifies the maximum number of frames collected in one packet.

The capacity of the buffer memory in the TH-D7 TNC is limited, so do not use too large a value for MAXFRAME.

- **Monitor commands**

1 MONITOR

Short form: M Default: ON Parameters: ON or OFF
Example: M ON

Function: Specifies whether or not packet communication is monitored.

ON: Monitors the packets, including packets not addressed to you.

OFF: Does not monitor (display) the packets.

2 MCOM

Short form: MCOM Default: OFF Parameters: ON or OFF
Example: MCOM ON

Function: Specifies the type of frame to be monitored.

ON: All frames are monitored.

OFF: Only I frames are monitored.

When ON is specified, the frame status is displayed between < > brackets. The details of this information are explained below. For more information on the meanings of the respective codes, refer to the AX.25 Protocol Specifications or the Packet Communication Handbook.

- Frame type
 - [I] Information (I)
 - [RR] Receive Ready (RR)
 - [RNR] Receive Not Ready (RNR)
 - [REJ] Reject (REJ)
 - [C] Connect request (SABM)
 - [D] Disconnect (DISC)
 - [DM] Disconnect Mode notification (DM)
 - [UA] Unnumbered Acknowledge (UA)
 - [FRMR] Frame Reject notification (FRMR)
 - [UI] Unnumbered Information (UI)
- Poll/final bit
 - [P] Poll bit ON
 - [F] Final bit ON
- Command/response identification
 - [C] Command
 - [R] Response
- Sequence number
 - [Rn] Receive sequence number ($n = 0 \sim 7$)
 - [Sn] Send sequence number ($n = 0 \sim 7$)

3 MCON

Short form: MC Default: OFF Parameters: ON or OFF
 Example: MC ON

Function: Specifies whether or not monitoring is performed while you are connected.

ON: Monitoring is performed while you are connected.

OFF: Monitoring is not performed while you are connected.

4 MALL

Short form: MA Default: ON Parameters: ON or OFF
 Example: MA ON

Function: When MALL is ON, all stations are monitored.

When MALL is OFF, only stations that have sent packets and are not yet connected are monitored.

5 MRPT

Short form: MR Default: ON Parameters: ON or OFF
Example: MR ON

Function: Specifies whether or not the digipeater path is included in the header. (The header shows the sender's and destination's call sign.)

ON: The path is included. An asterisk (*) is added to packets sent via digipeaters.

OFF: The path is not included.

6 TRACE

Short form: TRAC Default: OFF Parameters: ON or OFF
Example: TRACE ON

Function: When TRACE is ON, the frame content is displayed in detail. The frame is displayed in hexadecimal notation in the left block, and the ASCII codes are shown in the right block.

- **GPS Commands**

1 GBAUD

Short form: GB Default: 4800 Parameters: 4800 or 9600
Example: GBAUD 4800

Function: Sets the bit rate for the GPS port.

4800: Sets the bit rate to 4800.

9600: Sets the bit rate to 9600.

2 LPATH

Short form: LPA Default: GPS
Parameters: Destination call sign VIA digipeater 1, digipeater 2 ... digipeater 8
Example: LPA GPS

Function: Sets the destination (identifier) and digipeaters when a GPS beacon is sent. This corresponds to the UNPROTO of the beacon.

3 LOCATION

Short form: LOC Default: EVERY 0
Parameters: EVERY (E) or AFTER (A) 0 ~ 250
Example: LOC E 1

Function: Sets the interval used for the transmission of the message specified in LTEXT as a GPS beacon.

EVERY: The message is sent at intervals of the duration specified.

AFTER: The message is sent one time, when no packets have been sent for the period specified.

The time period is specified in units of 10 seconds. No GPS beacon is sent when 0 is specified.

This command corresponds to the BEACON command of the beacon.

4 LTEXT

Short form: LT Default: –
Parameters: up to 159 characters
Example: LTEXT text of LT

Function: The content of LTEXT is sent as a beacon at intervals of the LOCATION duration. If nothing is entered in LTEXT, no beacon is sent.

To clear the LTEXT message, use LT %.

In addition to being specified in LTEXT, the message text can also be set automatically using data from a connected GPS receiver. (GPSTEXT is used to set automatically specified messages.)

5 LTMON

Short form: LTM Default: 0 Parameters: 0 ~ 250
Example: LTMON 5

Function: The LTEXT message can be monitored. LTMON specifies the intervals of LTEXT monitor output (in seconds).

If 0 is specified, LTEXT is not monitored

You cannot monitor the packets you send as beacons. By using LTEXT to periodically display the packets being sent, you can check the current LTEXT message. This will, however, increase the load on the terminal software.



6 LTMHEAD

Short form: LTMH Default: ON Parameters: ON or OFF
 Example: LTMHEAD

Function: Specifies whether a header (call sign, etc.) is added to the simulated message displayed by LTMON.

ON: The header is added and sent to the COM port in the format used when data from other stations is displayed on the host computer monitor.

OFF: The header is not added. Only the LTEXT message is sent to the COM port.

7 GPSTEXT

Short form: GPST Default: \$PNTS
 Parameters: up to 6 characters
 Example: GPST \$GPRMC

Function: When the beginning of the data input from the GPS port matches the character string specified in GPSTEXT, the contents of LTEXT are automatically overwritten by the input data from the GPS port.

The GPSTEXT settings are shown in the table below. If the beginning of the input data does not match the GPSTEXT character string, the sentence specified in GPSTEXT is reconfigured using the previously interpreted GPS data and the result is used to automatically update LTEXT.

Sentences that can be interpreted	Sentences that can be reconfigured
\$GPGGA	\$GPGGA
\$GPRMC	\$GPRMC
\$GPVTG	\$GPVTG
\$GPZDA	\$GPZDA
SONY	\$PNTS

8 NTSGRP

Short form: NTSGRP Default: 000
 Parameters: 3 alphanumeric characters
 Example: NTSGRP ABC

Function: Specifies the group code used when a \$PNTS sentence is created.

Group codes consisting of 3 alphanumeric characters (0 ~ 9, A ~ Z) can be specified.

This code is used by the PC software to ensure that only beacons with matching group codes are displayed.

Note: This command is only used on the NAVITRA system in Japan.

9 NTSMRK

Short form: NTSMRK Default: 0 Parameters: 0 ~ 14
 Example: NTSMRK 13

Function: Specifies the icon number used when a \$PNTS sentence is created.

This icon number is used by the PC software to generate an icon when the position is plotted.

Note: This command is only used on the NAVITRA system in Japan.

10 NTSMMSG

Short form: NTSMMSG Default: –
 Parameters: 20 characters
 Example: NTSMMSG This is a test.

Function: Specifies the message used when a \$PNTS sentence is created.

The PC software is used to display this message at the same time the position is plotted.

Note: This command is only used on the NAVITRA system in Japan.

11 GPSEND

Short form: GPSEND Default: –
Parameters: Up to 240 characters
Example: GPSEND @SKB (“@SKB” is a command that sets the
IPS-5000 geodesic code to TOKYO.)

Function: Sends the specified character string to the GPS port. This command is used to initialize the GPS receiver.

The transmitted character string is not stored in memory. It must be specified each time.

Transmissions of long character strings or frequent transmissions may cause TNC malfunctions.

12 GPSMON

Short form: GPSMON Default: OFF Parameters: ON or OFF
Example: GPSMON ON

Function: Forwards data received via the GPS port directly to the host computer. GPSMON can be used to check GPS port operation or to check output from a connected device.

GPSMON can be used during TNC operation, but perfect operation of both devices cannot be guaranteed. Some packets or data may be lost.

The GPS receiver, depending on the model, transmits data each second. The TNC captures the data and transfers it to the main CPU. If packet data is received while the data from the GPS is being transferred, processing by the TNC overflows and it may receive the packet data incorrectly. Also, while receiving or transmitting packet data, it may stop transmitting the GPS data. Therefore, you can use GPSMON while monitoring the status of the GPS.

13 LOC10X

Short form: LOC10X Default: ON Parameters: ON or OFF
Example: LOC10X ON

Function: Changes the unit of the setup time.

ON: Normal operation (10 second step)

OFF: 1 second step

Transmitting a BEACON using a short interval will annoy other stations. In this case, turn LOC10X ON.

- **Other Commands**

1 DISPLAY

Short form: DISP Default: –
 Parameters: Class specification character
 Examples: DISP ; or DISP T

Function: Displays a list of the specified parameters.

DISP: All classes listed; DISP A: Lists the COM port settings; DISP C: Lists the special character settings; DISP H: Lists the health counter settings; DISP I: Lists the ID settings; DISP L: Lists the link settings; DISP M: Lists the monitor settings; DISP T: Lists the timing settings.

2 RESTART

Short form: RESTART Default: – Parameters: –
 Example: RESTART

Function: Restarts the system.

Some commands are only executed when the system is restarted, such as AWLEN.

3 RESET

Short form: RESET Default: – Parameters: –
 Example: RESET

Function: Resets all parameters to default and restarts the system.

Use RESET when you have changed a number of parameters and you are no longer sure what the settings are.

4 PORTOUT

Short form: PORTO Default: \$0000 Parameters: \$0000 ~ \$07FF
 Example: PORTO \$0000

Function: The designated output parameters are transferred via an expansive output port.

“bit0” corresponds to AUX0, “bit1” corresponds to AUX1, etc.. If the corresponding bit is 0, the “L” output is enabled. For bit 1, the “H” output is enabled.

“bit0” activates/deactivates the 3.5 V output of SPMIC (0: 3.5 V output). “bit1” activates/deactivates beat shift (0: normal, 1: shift ON). All other bits are not used.

Do not use the output port since it is used inside the TH-D7. Using the output port may cause abnormal operation of the TH-D7.

PORTOUT can be transferred while packet mode is ON.

- Health Counter**

You can view the status of the TNC in the Health Counter. If this counter is restarted, it will return to "0". You do not need to monitor the counter under normal operation.

Command name	Short form	Description
ASYRXOVR	AS	When you receive data from the computer, if an over-run occurs, the counter increases by 1.
BBFAILED	BB	In the TNC's RAM check sum error, the counter increases by 1.
HOVRERR	HO	When receiving packets, if the received HDLC is over-run, the counter increases by 1.
HUNDRERR	HU	When receiving packets, if the received HDLC is under-run, the counter increases by 1.
RCVDFRMR	RCVDF	While connected, if a frame refusal frame is received, the counter increases by 1.
RCVDIFRA	RCVDI	While connected, if a normal information frame is received, the counter increases by 1.
RCVDREJ	RCVDR	While connected, if a resend request frame is received, the counter increases by 1.
RCVDSABM	RCVDS	While connected, if a connect request frame is received, the counter increases by 1.
RXCOUNT	RXC	If the received CRC is a normal packet frame, the counter increases by 1.
RXERRORS	RXE	If the received CRC is an abnormal packet frame, the counter increases by 1.
SENTFRMR	SENTF	If a frame refusal frame is sent, the counter increases by 1.
SENTIFRA	SENTI	If an information frame is sent, the counter increases by 1.
SENTREJ	SENTR	If a resent request frame is sent, the counter increases by 1.
TXCOUNT	TXC	If a frame is sent, the counter increases by 1.
TXTMO	TXT	When sending packets, if the sent HDLC times out, the counter increases by 1.

AX.25 PROTOCOL

For communication to be successful, mutual agreements between the two parties are required. These agreements are referred to as protocols. For packet communication, the AX.25 link level protocol is used to avoid data transfer errors during communication.

The AX.25 transmission control protocol conducts data communication using the HDLC (High level Data Link) protocol.

AX.25 is the X.25 link level protocol modified and extended, as detailed below, so that it can be used for amateur radio. AX.25 was settled on by the American ARRL in 1984. The TNCs on the market all conform to this protocol. Information on the AX.25 protocol can be obtained from the TAPR web site.

- Amateur radio call signs can be used as addresses.
- Unaddressed unnumbered control information frames (UNPROTO on the TNC) added.
- Digipeater function.
- A function added that returns a busy signal when a connect request is received from another station while a connection is active.

In packet communication, data is collected into packets for transmission. A packet is a collection of frames (data blocks).

There are 3 types of frames: Information (I) frames, supervision (S) frames and unnumbered (U) frames.

I frames are used to send information. The other frames are used for tasks such as link control and sending retry requests when an error occurs.

Frame Configuration

S and U Frames:

Flag	Address	Control	FCS	Flag
01111110	Bits 112 ~ 560	8 bits	16 bits	01111110

I Frame:

Flag	Address	Control	PID	Information	FCS	Flag
01111110	Bits 112 ~ 560	8 bits	8 bits	8*N bits	16 bits	01111110

Flag: Contains the “01111110” string and is inserted at the beginning and end of the frame. Used to synchronize frames.

Address: Contains the destination station and digipeater call signs.

FCS (Frame Check Sequence): Contains an error detection code.

Information: Contains the information being sent. If the data consists of consecutive 1 bits, it can be mistaken for a flag. Consequently, a 0 bit is inserted after 5 consecutive 1 bits.

Under the AX.25 protocol, the I, S, and U frames can be further subdivided into 10 types of frames.

I	I	Information	Sends information.
S	RR	Receive Ready	Notifies the sender that the receiving party is ready to receive data.
	RNR	Receive Not Ready	Notifies the sender that the receiving party is not ready to receive data.
	REJ	Reject	Requests that a frame be resent.
U	SABM	Set Asynchronous Balanced Mode	Connection request.
	DISC	Disconnect	Disconnection request.
	DM	Disconnect Mode	Returns a busy signal to a connect request.
	UA	Unnumbered Acknowledge	Confirmation reply. Returns a connect OK message to a SABM and returns approval for disconnection to a DISC frame.
	FRMR	Frame Reject	Notifies the sender that a received frame contained a structural error, but the frame FCS was OK.
	UI	Unnumbered Information	Used to send information without making a connection. Used to send beacons.

Under the normal settings, only information frames are displayed. However, other frames can also be viewed by setting MCOM to ON.



PACKET COMMUNICATION SYSTEMS

In packet communication, many stations use the same radio channel, so packet collisions occur when packets are sent simultaneously. Packets may also fail to arrive correctly due to fading or channel noise.

Following is a brief look at the systems which allow multiple stations to use the same channel.

Throughput: This is the percentage of channel transmission speed that can actually be used for information transmission under a given access method. When the channel transmission speed is R bps, and the amount of information carried on that channel in 1 second is s bps, the throughput S is equal to s/R .

Traffic: This is the amount of information that actually flows along a channel in 1 second. The traffic level indicates how crowded a channel is.

The above is based on a channel in which packets are only resent due to collisions, not fading or noise.

ALOHA System

- **Original ALOHA System**

The original ALOHA system is a basic access method where stations transmit packets at their own discretion. Some packets sent this way overlap with other packets, rendering each entire packet useless, so channels are not used efficiently. The advantage of this protocol is that transmission control is extremely simple.

- **Slotted ALOHA System**

In the slotted ALOHA system, the timeline is chopped into “slots” of a set duration, and packets are then sent in accordance with these slots.

This system allows improved throughput because it avoids the problem of overlapping packets.

In this system, a central station is needed to determine when packets are sent, and stations must be synchronized with the central station.



- **CSMA System**

In the CSMA (Carrier Sense Multiple Access) system, the transmitting station monitors the channel before sending any packets. If the channel is busy, the station waits until it is free before sending a packet. This system is normally used in packet communications.

This system is also unable to eliminate packet collisions. Communication is affected by the packet transmission delay time and the time required by the transceiver for switching between receiving and sending. These delays result in packet collisions.

There are 2 types of CSMA systems: nonpersistent CSMA and p-persistent CSMA.

- ◆ Nonpersistent CSMA

Data is sent if the channel is free. If the channel is busy, the station waits for a set interval and then checks to see if the channel is still busy. If the channel is free, it sends the data. If the channel is still busy, it waits for the set interval again and then checks the channel.

- ◆ P-persistent CSMA

Data is sent if the channel is free. If the channel is busy, the station waits until the channel is free and then switches to send mode.

All stations will try to send their data as soon as the channel becomes free, so the risk of collisions increases. To prevent this, when the station confirms that the channel is empty, it sends the data when the probability value of p is obtained. When the probability value is $p-1$, it waits for the set interval, checks the channel and then either sends the data or waits based on the probability value. This procedure is then repeated.

Sending packets based on probability values minimizes packet collisions.

When the sending station can ascertain the channel status, the CSMA system is an excellent method. However, if the signal does not actually arrive, packets may be sent when the channel is busy.



Graphs of the throughput for the ALOHA and nonpersistent CSMA systems are shown below. These show the high throughput obtained using the nonpersistent CSMA system. Note, however, that the throughput for the nonpersistent CSMA system also declines when a large delay time is used.

Original ALOHA/ Slotted ALOHA System

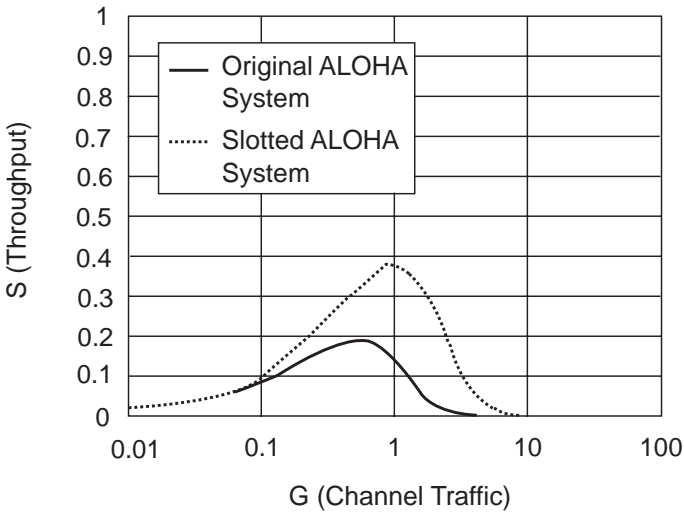

non-persistent CSMA

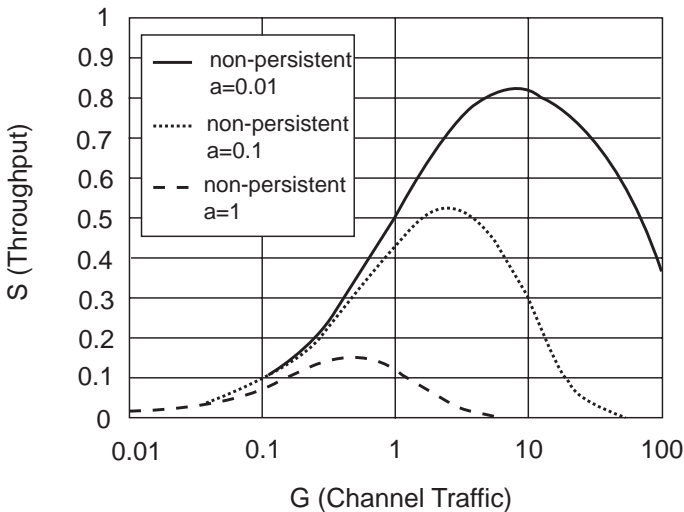

REFERENCE MATERIALS

■ References

- Packet Communications Handbook: CQ Publications
- Packet Radio Networks: CQ Publications

■ Web Sites

TAPR: <http://www.tapr.org/>

PLUG: <http://www.prug.or.jp/>

NMEA: <http://www.nmea.org/>



GPS

ABOUT GPS

The Global Positioning System (GPS) was originally developed by the US Department of Defense for military applications, and then made partially available for public use. For military usage, accuracy is at the millimeter level. However, for public usage, accuracy is only at about the 100 meters level due to Military-induced Selective Availability. The signal is scrambled just enough to reduce the accuracy to public-use levels.

The GPS satellite network has 24 satellites that orbit at an altitude of 20,000 km. There are 4 satellites in each of 6 separate orbital paths. You can receive 6 or 7 satellites at any time and place. Each satellite transmits a repeating signal including the position, orbital parameters of itself and the other satellites, and the precise atomic time. The satellites use 1575.42 MHz, with a 2.046 MHz bandwidth signal, and Spread-spectrum (SS) modulation that can emit 24 signals on the same frequency.

How does the GPS system work?

The system measures distance to the satellite using the signal traveling time. If you draw a circle with a radius of this distance around the satellite's known position, the circles around the satellites should intersect at 1 point, which is the real position. The complex mechanisms that make this measurement are included in the satellites and GPS data.

COMPATIBLE GPS RECEIVERS

■ Basic Requirements

A GPS receiver to be connected to the TH-D7 must meet the specifications listed below. Some GPS receivers allow you to select the output data format and transmission speed.

- GPS receivers capable of NMEA-0183 compliant output.

Set the bit rate to 4800 bps for communication at 4800 bps. (Some GPS receivers can communicate at 9600 bps. Set their bit rate to 9600 bps.)

- GPS receivers that send data starting with "SONY...", (SONY IPS-5000 and 3000 series, and the PACY-CNV10).

Set the bit rate to 9600 bps for communication at 9600 bps.

- EIA-422 or EIA-232 output level.



GPS Interface Settings:

Bit rate: 4800 (default) or 9600 bps. Set using GBAUD.
 Data bits: 8 bits
 Parity: none
 Stop bits: 1 bit
 Flow control: none

■ GPS Sentences

The TH-D7 built-in TNC can interpret the following 6 sentences:

- SONY (Japan only)
- \$GPGGA
- \$GPRMC
- \$GPVTG
- \$GPZDA
- \$PNTS

1 SONY (Japan only)

This format is output by receivers such as the SONY IPS-5000.

This is data with a fixed length of 110 bytes starting with "SONY" and ending with [CR][LF]. This data includes the date, time, latitude, longitude, height, speed, direction, and satellite information.

```
SONY809507016090346N3546569E13918458+0218004013950701
6090345D4BDHIFGXHbCIRDFFFPEiFHSCKCQGBRFFeBEDDcCOCH
dDH1O<CR><LF>
```

SONY 80 GPS receiver firmware version.

950701 Current year, month, and day.

6 Current weekday.

090346 Current UTC (Coordinated Universal Time) time.

N Latitude North (S = South). Lowercase letters are used when the latitude cannot be plotted.

3546569 Latitude. Commands can be used to set this to DMD display (same as NMEA) or DMS display. A field at the end of the data indicates which display format is used. The latitude in this example would be 35°46.569 minutes (DMD), or 35°46 minutes and 56.9 seconds (DMS).

E Longitude East (W = West). Lowercase letters are used when the longitude cannot be plotted.

- 13918458 Longitude. Commands can be used to set this to DMD display (same as NMEA) or DMS display. A field at the end of the data indicates which display format is used. The longitude in this example would be 139°18.458 minutes (DMD) or 139°18 minutes and 45.8 seconds (DMS).
- +0218 Height in meters. This corresponds to the NMEA geodesic height.
- 004 Speed (in km/hour).
- 013 Direction of movement. True bearing. North is given as 000° with values increasing to 360° while rotating clockwise.
- 950701 Date of measurement of latitude, longitude, height, speed, and direction.
- 6 Day of the week for the above.
- 090345 Time of the above. (Normally 1 second before the current time.)
- D DOP (Dilution Of Precision) value. A to Q are used to indicate the corresponding DOP value.
- 4 Measurement calculation mode. 3 indicates 2-Dimensional, and 4 indicates 3-Dimensional.
- B Geodesic code. (B indicates TOKYO (Japan and Korea).)
- DHIFG Satellite status received on channel 1.
- XHbCI Satellite status received on channel 2.
- RDFFF Satellite status received on channel 3.
- PEiFH Satellite status received on channel 4.
- SCKCQ Satellite status received on channel 5.
- GBRFF Satellite status received on channel 6.
- eBEDD Satellite status received on channel 7.
- cCOCH Satellite status received on channel 8.
- (The first character is the satellite number. The second is the satellite's angle of elevation. The third is the satellite's angle of movement. The fourth is the channel operation status. The fifth is the signal level.)
- d Status of the reference oscillator built into the GPS receiver.
- DH ??? Information not relating to the users.
- 1 Latitude and longitude display format. A letter indicates DMS and a number indicates DMD.
- O Parity. This indicates the final bit in the checksum for all the ASCII codes that precede this letter. O = 0 (zero) and E = 1.
- <CR><LF> End of data.



2 \$GPGGA

This is one of the output formats stipulated by NMEA-0183. It gives the time, latitude, longitude, and height. It does not give the date, speed, and direction.

\$GPGGA,hhmmss.ss,IIII.II,a,yyyy.yy,a,x,xx,x.x,x.x,M,x.x,M,x.x,xxxx*hh<CR><LF>

\$	Start of the sentence.
GP	Talker identification.
GGA,	Sentence identification.
hhmmss.ss,	Hours, minutes, and seconds (UTC). Decimals are optional.
IIII.II,	Latitude. 1234.56 indicates a latitude of 12°34.56 minutes (not 56 seconds). Four (4) integers are used, decimals are optional.
a,	N for latitude North. S for latitude South.
yyyy.yy,	Longitude. Five (5) integers are used, decimals are optional.
a,	E for longitude East. W for longitude West.
x,	GPS quality indicator. <ul style="list-style-type: none"> 0: Information is not valid. 1: Information is valid (GPS fix). 2: DGPS measurement is in progress. 3: Military codes are used.
xx,	The number of satellites being tracked (00 ~ 12).
x.x,	DOP (Dilution of Precision) indicates the horizontal dilution of position.
x.x,	Altitude above sea level.
M,	Unit of altitude, fixed at "M" (meters).
x.x,	Height above geoid surface (the surface of the elliptical sphere used to represent the Earth).
M,	Unit of height above the geode, fixed at "M" (meters).
x.x,	Age of the DGPS data (time in seconds since the last DGPS update).
xxxx	DGPS reference station ID (0000 ~ 1023).
*hh<CR><LF>	Checksum and end of sentence. (The checksum is an exclusive logical sum (XOR) expressed as an ASCII code between \$ and *. This value is represented by an asterisk (*) followed by a hexadecimal number. The checksum and asterisk can be omitted.)

3 \$GPRMC

This is one of the output formats stipulated by NMEA-0183. It gives the date, time, latitude, longitude, speed, and direction.

\$GPRMC,hhmmss.ss,a,lll.l,II,a,yyyy.yy,a,x.x,x.x,ddmmyy,x.x,a*hh <CR><LF>

\$ Start of the sentence.

GP Talker identification.

RMC, Sentence identification.

hhmmss.ss, Hours, minutes, and seconds (UTC).

a, Status. A indicates valid data. V indicates invalid data.

lll.l, Latitude.

a, N for latitude North. S for latitude South.

yyyy.yy, Longitude.

a, E for longitude East. W for longitude West.

x.x, Land speed in knots.

x.x, Direction in degrees.

ddmmyy, Date (day, month, and year). (The year is given as 2 digits.)

x.x, The magnetic variation in degrees.

a The magnetic variation, W or E (West or East).

*hh<CR><LF> Checksum and end of GPRMC sentence.

4 \$GPVTG

This is one of the output formats stipulated by NMEA-0183. It gives the speed and direction.

\$GPVTG,x.x,T,x.x,M,x.x,N,x.x,K*hh<CR><LF>

- \$ Start of the sentence.
- GP Talker identification.
- VTG, Sentence identification.
- x.x, True bearing value. Angle (in degrees) relative to true North.
- T, Indicates "true bearing".
- x.x, Magnetic bearing value. Angle (in degrees) relative to magnetic North (as indicated by a compass).
- M, Indicates "magnetic bearing".
- x.x, Speed in knots. (Nautical miles per hour. Equivalent to 1.852 kilometers per hour.)
- N, Indicates "knots".
- x.x, Land speed in kilometers per hour. This can generally be taken simply as the speed.
- K Indicates "km/hour".
- *hh<CR><LF> Checksum and end of message.

5 \$GPZDA

This is one of the output formats stipulated by NMEA-0183. It gives the date and time.

\$GPZDA,hhmmss.ss,xx,xx,xxxx,xx,xx*hh<CR><LF>

- \$ Start of the sentence.
- GP Talker identification.
- ZDA, Sentence identification.
- hhmmss.ss, Hours, minutes, and seconds (UTC).
- xx, Day (01 ~ 31).
- xx, Month (01 ~ 12).
- xxxx, Year. (The year, month, and day are UTC.)
- xx, Time zone (-13 ~ +13 hours).
- xx Time zone (00 ~ +59 minutes).
- *hh<CR><LF> Checksum and end of sentence.

6 \$PNTS

This is a private sentence that conforms to NMEA-0183. It is used by the Navitra system in Japan.

As well as the date, time, latitude, longitude, speed, and direction, this sentence also includes a short message, the group code, and the icon number.

\$PNTS,x,a,dd,mm,yyyy,hhmmss,x.x,a,x.x,a,dd,xxx,i,mes,grp,x*hh<CR><LF>

\$PNTS,	Start of the PNTS sentence.
x,	PNTS sentence version (currently 1).
a,	Registration information. The meanings of these codes are: <ul style="list-style-type: none"> 0: Normal position data. Only this can be reconfigured by the TH-D7 TNC firmware. S: Starting position data for course setting. E: Ending position data for course setting. 1: Course setting intermediate data. P: Position registration data. A: Confirmation data when automatic position transmission is set to OFF. R: Confirmation data when the course data and position data is received.
	(A and R are immediately followed by the checksum.)
dd,	Day.
mm,	Month.
yyyy,	Year.
hhmmss,	Time.
x.x,	Latitude in DMD format (3549.508 is displayed as 35°49.508 minutes).
a,	N for latitude North. S for latitude South.
x.x,	Longitude in DMD format (13910.028 is displayed as 139° 10.028 minutes).
a,	E for longitude East. W for longitude West.
dd,	Direction of movement given in 64ths of 360°. (00 is North and 16 is East.)
xxx,	Speed in km/hour.

- i, Icon. One of 15 types from 0 ~ 9 or A ~ E. When reconfigured by the TH-D7 firmware, the value specified by the NTSMRK command is inserted.
 - mes, Message up to 20 bytes long. When reconfigured by the TH-D7 firmware, the character string specified in the NTSMMSG command is inserted.
 - grp, Group code. A 3 character code using the numbers 0 ~ 9 and the characters A ~ Z. When reconfigured by the TH-D7 firmware, the character string specified in the NTSGRP command is inserted.
 - x Sentence status. 1 is valid and 0 is invalid.
- *hh<CR><LF> Checksum and end of PNTS sentence.

SSTV

OUTLINE OF SSTV

Slow Scan Television (SSTV) is “still image transmission” using audio frequency. Field experts have applied television techniques to develop SSTV. Broadcast television uses a bandwidth of 4.5 MHz but SSTV uses a bandwidth of 3 kHz (audio frequency) which sends scanned images at 120 lines per frame.

SSTV has enjoyed a long history in the amateur radio world. From the initial black and white transmissions, amateur radio enthusiasts have worked to develop a number of transmission methods.

Even so, SSTV never got much attention. This is due to the fact that commercial equipment was very expensive and complicated. The situation has changed in the last couple of years. Newer equipment is both simple to use and affordably priced. Now, if you have an amateur radio license and a scan converter to allow you access to these transmissions, you can easily send and receive still images. Amateur radio operators who exchange images generally use SSB in the HF band (7 MHz, 14 MHz, etc.). Images are exchanged between amateur radio users worldwide.

■ Software SSTV

SSTV has recently become popular using software only. This is done by using the sound card on a PC as the interface with a transceiver and performing all the processing on the PC. W95SSTV and WinPix32 are typical examples.

These software applications are available via the following web sites on the Internet.

W95SSTV: <http://www.siliconpixels.com/>

WinPix32: <http://www.skypoint.com/~k0heo/>

■ New Hardware

The **KENWOOD** VC-H1, an Interactive Visual Communicator, is a compact SSTV system. It was designed for plug-and-play color SSTV and includes a slow scan converter, a CCD camera, and an LCD (refer to page 105, “VC-H1 CONTROL”).



Ordinary system configuration



System configuration newly presented by **KENWOOD**



TRANSMISSION METHODS

SSTV uses analog signals for transmitting sub-carrier frequency modulation and demodulation is performed using arc tangent angle detection. The basic transmission methods are the RGB line sequence method (RGB) and the component method (YC); luminance (Y) and chrominance (C) signals sent sequentially. Various modes exist within these methods depending on the signal format. The table below, shows the modes supported by the VC-H1. A high-speed mode (Fast FM) is also available.

Transmission Modes:

Mode	Scan time (in seconds)	Format	Scan line
Robot C36	36	YC	240
Robot C72	72	YC	240
AVT90	90	RGB	240
AVT94	94	RGB	200
Scottie S1	110	RGB	240
Scottie S2	71	RGB	240
Martin M1	114	RGB	240
Martin M2	58	RGB	240
Fast FM	14	YC	240

Robot: Developed by Robert Research Corporation (U.S.A.) for their scan converter.

AVT (Amiga Video Transceiver): Developed by Ben Blish-Williams (U.S.A.).

Scottie: Developed by Ed Murphy, GM3BSC (Scotland).

Martin: Developed by Martin Emmerson, G3OQD (England).

Fast FM: Developed by **KENWOOD** for the VC-H1.

These modes handle images as analog signals. The characteristics of analog signals is that transmissions are not interrupted, but the image quality is impaired due to interference (noise) on the transmission path. A brief explanation of Robot C36, the most popular of these transmission modes, is given on page 98.

This CD-ROM contains sample images transmitted in each mode using the VC-H1 and TH-D7. These images have been saved in bit map file format (with "bmp" extensions) under the "SSTV" directory. Each file name includes the name of a transmission mode; for example, KENWOOD_RobotC36.bmp. The original images have been saved using file names which include "original".



Procedure of test:

- 1 Capture the image on the VC-H1.
- 2 Transmit the captured image with each mode.
- 3 Receive the image on the VC-H1.
- 4 Transfer the received image to the PC.

Transmission time by Mode (TH-D7 with VC-H1)

Conditions:

- RX: VOL set to center
- Battery Saver function is OFF
- Frequency set to 432.300 MHz
- Output power set to EL

Measurement

- Start: Press **[TX]** on the VC-H1.
- End: Transmission end.

	1st try	2nd try	3rd try	4th try	5th try	Average	Nominal value
ROBOT C36	38.38	38.34	38.25	38.34	38.34	38.330	36 sec.
ROBOT C72	74.41	74.31	74.38	74.28	74.31	74.338	72 sec.
AVT 90	99.53	99.53	99.54	99.47	99.51	99.516	90 sec.
AVT 94	103.22	103.21	103.28	103.25	103.18	103.228	94 sec.
SCOTTIE S1	111.91	111.93	111.97	111.91	111.91	111.926	110 sec.
SCOTTIE S2	73.50	73.50	73.47	73.41	73.44	73.464	71 sec.
MARTIN M1	116.63	116.54	116.66	116.72	116.56	116.622	114 sec.
MARTIN M2	60.31	60.37	60.34	60.38	60.35	60.350	58 sec.
FAST FM	15.16	15.22	15.15	15.12	15.16	15.162	14 sec.



■ Robot C36

Robot C36 is the method in which the image is divided into a single luminance signal (Y) and two chrominance signals (R-Y and B-Y). This mode uses less memory than RGB. Y, R-Y and Y, B-Y are alternately sent on each line and the receiving station synthesizes the component signals to form a color image. The signals consist of a 1200 Hz synchronizing signal, a VIS signal (mode identifier), and the image signals (see the figure below). The VIS signal is a 10-bit, 300 millisecond signal including synchronization with "0" for 1300 Hz and "1" for 1100 Hz.

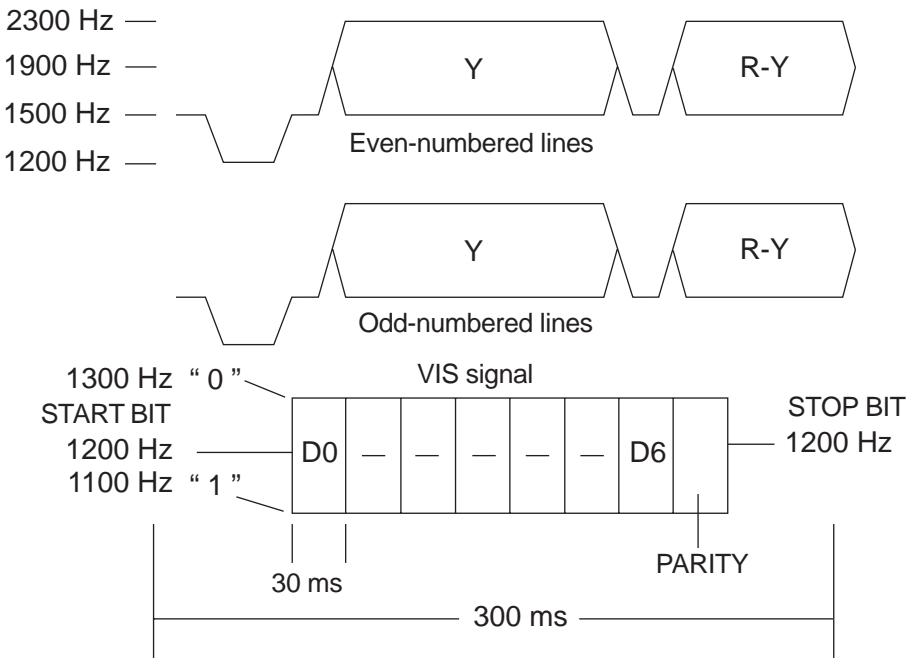

The figure below gives a simple overview of how this method works. An image captured using a CCD camera is output as an analog signal (normally as NTSC composite signals in Japan). The advantage of NTSC is that it has a bandwidth of 4 MHz and provides a horizontal resolution of 350 lines. This signal is sampled and converted from digital to analog format, decoded to Red, Green, and Blue components and stored in memory. The RGB components are separated into luminance (Y) and chrominance (R-Y and B-Y) signals. The Y, R-Y, and B-Y signals are modulated using sub-carrier modulation. Because of the restrictions on the band-pass-frequencies that can be handled on radio, the 2300 Hz frequency is used for white, the 1500 Hz frequency for black, and the color image components are transmitted on the frequency variations in between. The receiving station demodulates the signals, separates the Y and C components, then converts the luminance and chrominance signals to RGB. Now they can be displayed on a monitor. For a more detailed explanation, refer to a textbook on SSTV.

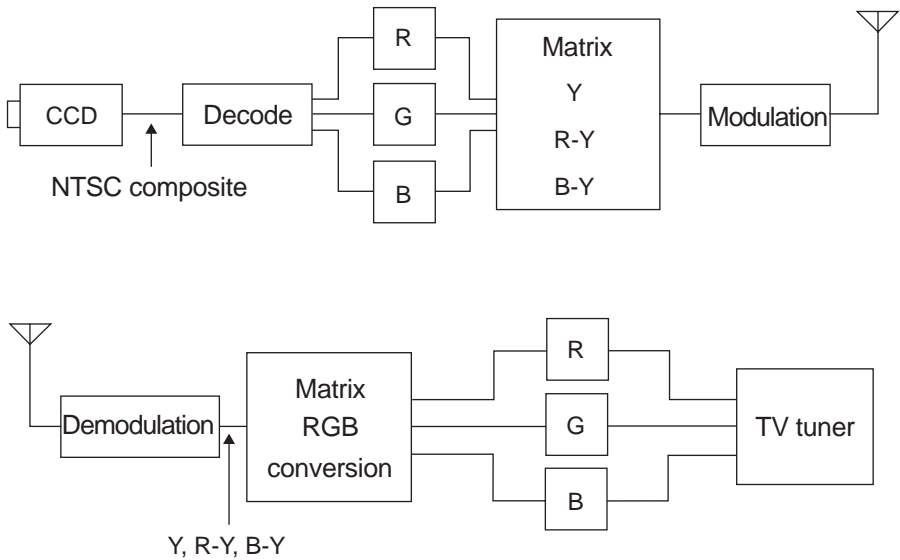

■ Fast FM Mode

In the basic thinking underlying SSTV, the transmission modes are designed to operate in the 300 Hz to 3 kHz bandwidth for radio signal transmission. In recent years, most VHF/UHF FM transceivers support 9600 bps packet communication. This extends the upper limit for transmission frequencies to 7 kHz.

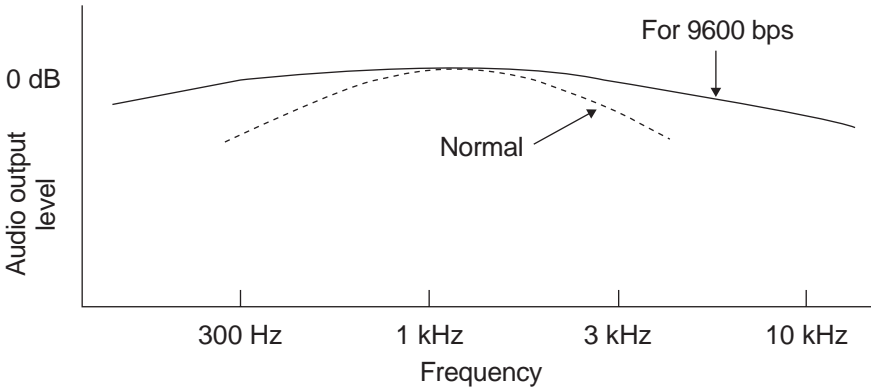

Using an expanded bandwidth of 7 kHz, you can transmit images twice as fast. This is the Fast FM mode idea used in the VC-H1. Fast FM mode uses Robot C36 ideas and transmission time is halved to only 18 seconds (see the table below). The time can be further reduced by 25% using analog band compression, that takes advantage of the way people view images, which means the final transmission time for the full-color image is only 14 seconds. Because this mode uses 9600 bps communication in the FM band, it can only be used by VHF/UHF transceivers. Fast FM mode transmitted image quality is equal to or better than the quality of Robot C36.

Comparison of Specifications:

Specification	Robot C36		Fast FM Mode
Format	SCFM		SCFM
Maximum image frequency	850 Hz		3200 Hz
Sub-carrier frequency	White	2300 Hz	4400 Hz
	Black	1500 Hz	2800 Hz
Synchronous frequency	1200 Hz		1200 Hz
Maximum frequency deviation	±550 Hz		±800 Hz



Fast FM mode Format

Signal Format:

1	2	3	4	5
---	---	---	---	---

1	1 second 1900 Hz tone
2	0.3 second VIS signal Uses code DAH and made up of 1200 Hz, 1300 Hz, 1100 Hz, 1300 Hz, 1100 Hz, 1100 Hz, 1300 Hz, 1100 Hz, 1100 Hz, 1200 Hz signals every 30 milliseconds.
3	62 millisecond bit synchronizing signal 31-bit M-series F9A42BB0H (LSB invalid) with a scattered 5-bit start location recognition signal; the first 4 bits are zero and the last bit is 1. "1" bits are scattered at 12.4 milliseconds and 1 carrier clock cycle is 400 μ seconds. HIGH signals are sent at 3912 Hz and LOW signals at 3288 Hz.
4	240 cluster signal 53.6 milliseconds x 240 lines = 12.87 seconds. 1 cluster signal (35.2 + 0.4 + 17.6 + 0.4 = 53.6 milliseconds) Y chrominance signal sent in the 4:2:0 format. Y (luminance signal) of 35.2 milliseconds, black sent at 2800 Hz, white at 4400 Hz with FM modulation, 352 dots sent at 1 clock cycle of 100 μ seconds. Blanking: 0.4 milliseconds. 3600 Hz tone sent for 0.4 milliseconds. Chrominance signal (odd-numbered lines Cr, even-numbered lines Cb) of 17.6 milliseconds with black (zero) at 3600 Hz and modulation of 3600 \pm 800 Hz. Blanking: 0.4 milliseconds, 3600 Hz tone sent for 0.4 milliseconds.
5	1 second 1900 Hz tone

- Band required for signal transmission: 1000 Hz ~ 6200 Hz
- At signal reception, the VIS signal is received normally and, when Fast FM mode is acknowledged, a command is sent to the transceiver to switch the SP line to Fast mode. The transceiver must switch the receive circuit to Fast mode within 10 milliseconds. This is if the SP line is to be used for both Fast mode and other modes. The same procedure is used when sending in Fast mode, and a command is needed to switch the modulation line.



■ TH-D7 Fast FM Mode and Voice

When using the PG-4V to connect the VC-H1 to the TH-D7, you can superimpose text, such as your call sign, and select the transmission mode. The bandwidth for the Fast FM transmission mode is wider than that for voice. You can use Fast FM mode on the TH-D7 when you are using the VC-H1 as a speaker/microphone. Following is an explanation on how to switch between Fast FM mode and voice mode.

• Switching for Reception

When the VC-H1 receives a Fast FM mode VIS signal, it sends the SR1 command to the TH-D7. When the TH-D7 receives the SR1 command, it switches the AUDIO AMP OFF and switches the FAST FM AMP ON (refer to the schematic chart for Fast FM mode on page 103). By switching the circuit, the TH-D7 sends the signals for the level and band required for Fast FM mode to the VC-H1. When signal transmission is finished, the VC-H1 sends the SR0 command to the TH-D7, which switches the audio circuit back to voice mode.

• Switching for Transmission

When you press [TX] on the VC-H1 while you are in Fast FM mode, it sends the ST1 command to the TH-D7. When the TH-D7 receives the ST1 command, it switches the FAST FM MIC AMP ON. When transmission ends, the circuit is reset to its initial status.

Note: If you receive SSTV in dual-band operation mode, the VC-H1 may malfunction due to interference from bands other than SSTV (noise on the screen, failure to switch to Fast FM mode, etc.). When this occurs, use single-band mode or change the A-B volume balance.



Schematic chart for Fast FM mode:

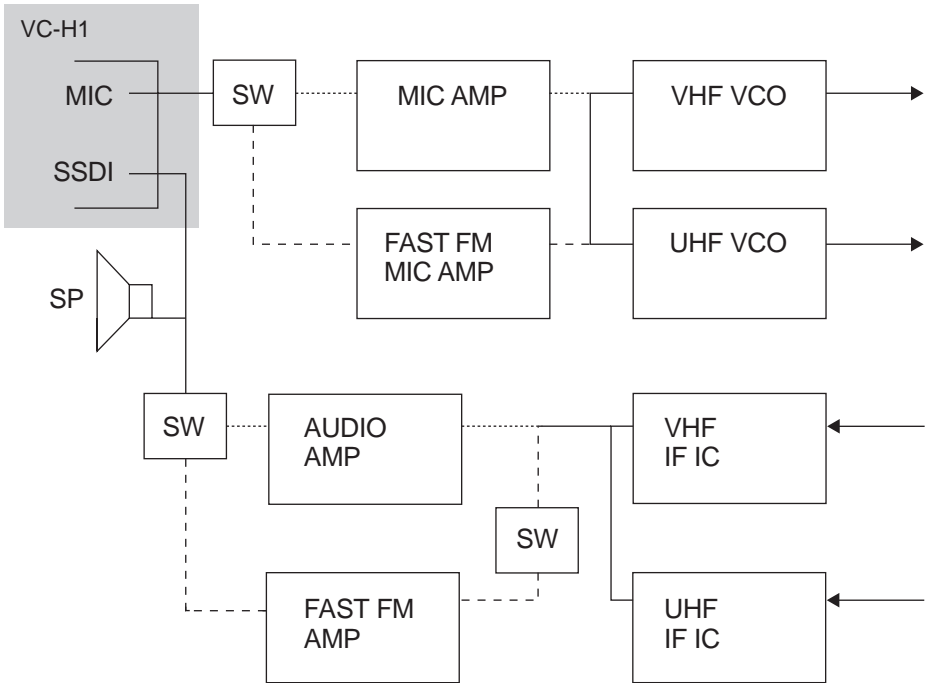

TH-D7

RSV REPORT

Readability		Signal strength		Video	
5	Perfect	9	Extremely strong	5	Perfect (no noise)
4	Readable with no difficulty	8	Strong	4	Slight noise
3	Readable with some difficulty	7	Fairly strong	3	A lot of noise; still recognizable
2	Barely readable	6	Good	2	Barely recognizable
1	Unreadable	5	Fairly good	1	Not recognizable
	—	4	Weak but perceptible		—
	—	3	Weak		—
	—	2	Very weak		—
	—	1	Faint		—



VC-H1 CONTROL

When the PG-4V is used to connect the VC-H1 to the TH-D7, you can enter text on the VC-H1 screen. You can also set the transmission mode and send images in response to image transmission requests from other stations.

■ Superimposing

You can use superimposing to transmit your call sign, message, and RSV report to the VC-H1. Entries with no text entered are not transmitted. Superimposing also works when an image stored in the VC-H1 memory is open.

• Entering Text

You can separately enter the following text to the images:

- ◆ Call sign: Up to 8 characters (A ~ Z (capitals only), 0 ~ 9, a space, !, ?, -, and /).
- ◆ Message: Up to 9 characters (A ~ Z (capitals only), 0 ~ 9, a space, !, ?, -, and /).
- ◆ RSV report: Up to 10 characters (A ~ Z (capitals only), 0 ~ 9, a space, !, -, and /).

• Text Color

You can use different colors to enter your call sign, message, and RSV report. The available colors are white, black, red, magenta, green, cyan, and yellow.

■ Setting the Transmission Mode

You can specify any of the following 9 transmission modes:

ROBOT C36, ROBOT C72, AVT 90, AVT 94, SCOTTIE S1, SCOTTIE S2, MARTIN M1, MARTIN M2, or FAST FM

Simply selecting the transmission mode completes VC-H1 setup or when you receive image data, the sender's transmission mode is automatically used.

■ VC Shutter

You can reply to an image transmission request from another station. The VC-H1 captures the image, superimposes it, then transmits the image to the requested station. Requests from other stations can be issued by sending the same CTCSS frequency as your transceiver for at least 1 second. To prevent superimposing, delete all the entered text. (Refer to the VC-H1 Instruction Manual for detailed setup information.)



■ PG-4V Connection Chart

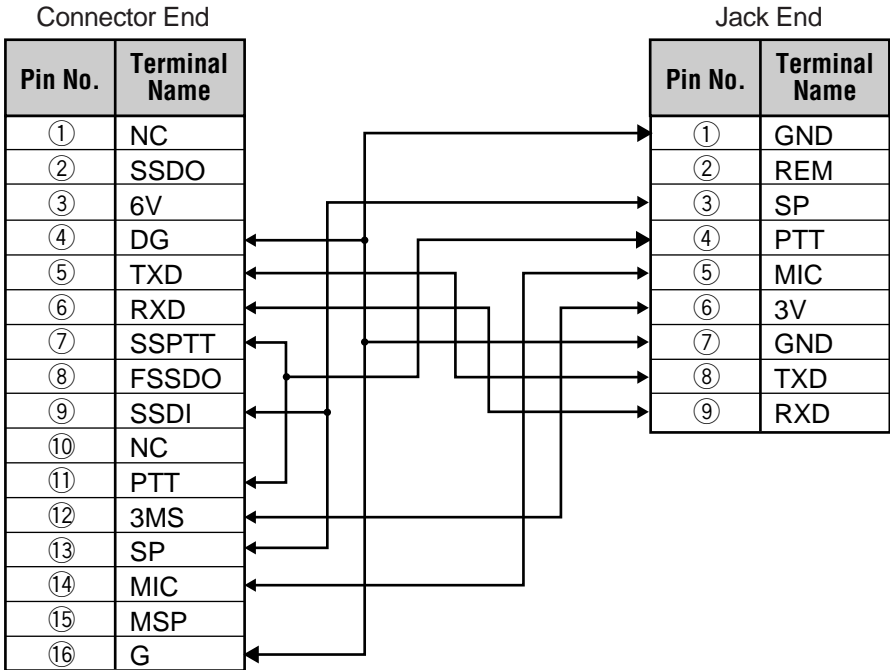
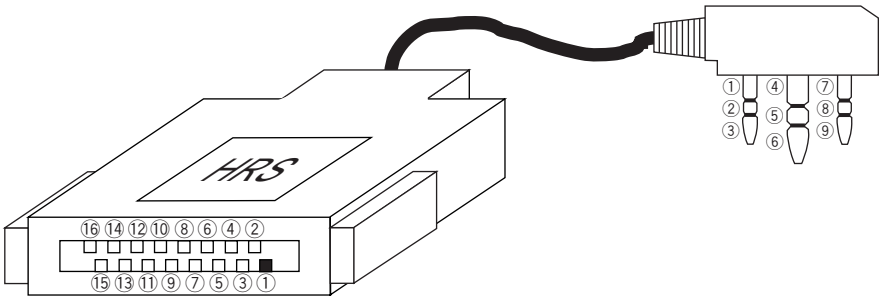

REFERENCE MATERIALS

■ References

- SSTV Handbook, published by CQ Publications

■ Web Sites

JF1QCI: <http://www.hi-ho.ne.jp/~jf1qci/index.htm>

SSTV: <http://www.ultranet.com/~sstv/>



SKY COMMAND II

KENWOOD Sky Command provides a system wherein the portable transceiver is used as a wireless remote control, microphone, and repeater, used in operation with the TS-570S (G)/D (G) and/or TS-870S HF transceivers.

Sky Command II is only available on the TH-D7A.

Wireless remote control operation has been achieved through the utilization of the TH-D7A built-in TNC and CTCSS functions, and the HF transceiver's PC control functions.

This system is capable of transmitting and receiving HF radio signals, changing over from transmit to receive, setting frequencies, switching memory channels, and other functions. The HF transceiver status (frequency, mode, etc.) can be displayed on the TH-D7.

Sky Command II provides a wireless microphone system over a short distance. Accordingly, it is very useful in the following situations:

- Watching for DX, schedules, or tuning the bands while working around the house.
- Operating HF radio while relaxing in your living room, instead of in the shack.
- Operate in the shack without carrying a wired microphone around.
- Operate HF while camping, picnicing, or at local sporting events (HF in the mobile).

At present, Sky Command II is capable of communication in voice mode. Use SSB/AM/FM modes.

These operations require the optional PG-4R.

The setup procedure is described in each instruction manual (TH-D7A, PG-4R, TS-570S (G)/D (G), and TS-870S). This explanation gives the recommended setup and notice.



RECOMMENDED SETUP

■ Before Connecting the Transceivers

Check the status of the HF transceiver. You cannot control settings such as the antenna selection and DSP settings from the TH-D7. These must be set beforehand. Set the MIC gain and AF gain knobs to 12 o'clock.

Select the desired band and mode and make sure you are sending and receiving on the correct frequencies. If the antenna SWR is too high, it may cause problems such as oscillation.

Use the menus on the HF transceiver to set the communication speed to 9600 bps and the stop bit to 1 (default).

Ensure that the TH-D7 to be used as the Transporter (connected to the HF transceiver) has a separate power supply from the HF transceiver. (We recommend you run the Transporter and Commander on battery power). Switch on both the Commander and Transponder TH-D7s, then select both VHF and UHF frequencies that are free of interference. Both TH-D7s must have the same VHF/UHF frequency settings.

■ Connecting the Transceivers

Switch the transporter and HF transceiver OFF, then use the PG-4R to connect them. The SP and PC look alike, so be careful not to connect them wrong.

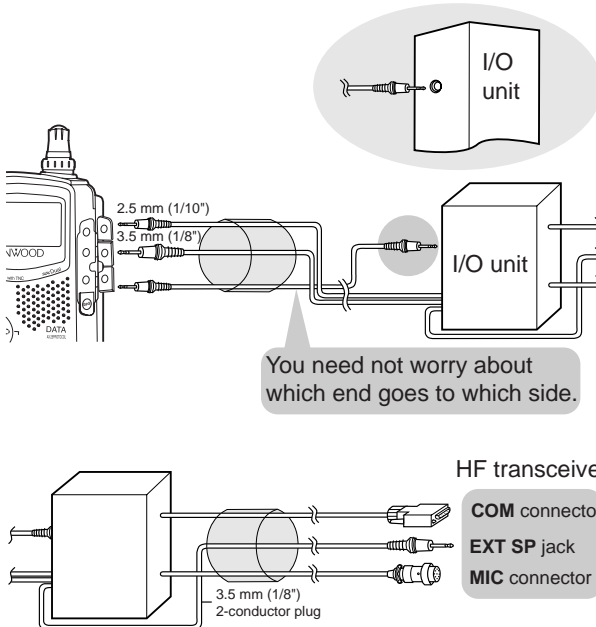

■ Transporter and Commander Setup

Switch on the HF transceiver, Transporter, and Commander, then set up the Commander and Transporter. The following settings are required (refer to the TH-D7 Instruction Manual).

Commander	Transporter
VHF frequency	VHF frequency (same frequency as the Commander)
UHF frequency	UHF frequency (same frequency as the Commander)
Call sign for Commander (Menu 4-1)	Call sign for Commander (Menu 4-1)
Call sign for Transporter (Menu 4-2)	Call sign for Transporter (Menu 4-2)
Tone frequency (Menu 4-3)	Tone frequency (Menu 4-3)
Commander ON (Menu 4-4)	Transporter ON (Menu 4-4)

Confirmation:

Press **[0]** (sync) and check that the HF transceiver settings are displayed on the commander.

If the commander emits 3 short beeps after a short time and the display does not change, the connection has failed. If you wait a while, then press **[0]** (sync) several times and the display still does not change, re-check the settings.

Check the following:

- The Commander and Transporter frequencies.
Refer to page 112, "NOTICE AND RESTRICTIONS ON ACTUAL USE" for information.
- The PG-4R is firmly connected to the Transporter.
- The call sign is correct.

The call sign programmed in Menu 4-1 on the Commander must match the one in Menu 4-1 on the Transporter. The call sign programmed in Menu 4-2 of the Commander must match the one in Menu 4-2 on the Transporter. Unless these two conditions are satisfied, the Commander and Transporter cannot identify each other.

■ Send/Receive Check

When the HF transceiver settings are displayed on the Commander, press **[2]** (RX) to receive HF audio on the Commander. Adjust the AF GAIN on the HF transceiver and Transporter, then press **[PTT]** and adjust the MIC GAIN on the HF transceiver so there is no distortion.

■ On Air

If the send/receive check finds no problems, you are ready to go on air.

Sky Command II allows you to remotely operate your HF transceiver. This is very useful when watching for DX, schedules, or just tuning the bands while working around the house. It also allows for HF operation when you are camping or picnicing and HF rig is securely mounted in your vehicle.

Adjustments such as changes to the frequency are slower than making adjustments directly using the HF transceiver keypad. This is because the control commands are sent to the HF transceiver using 1200 bps packet communication. Making continuous changes to the frequency by turning the dial on the commander does not produce continuous changes on the HF transceiver. When the dial stops turning, the frequency displayed at that point is sent to the HF transceiver and the frequency then changes. If you press **[RIT/XIT]** up or down once and then send or receive a packet, the frequency is changed by 0.01 kHz.

Thus, Sky Command II is not suitable for situations where you are watching for a signal by continually changing the frequency and where data may end up being sent on the wrong frequency.



NOTICE AND RESTRICTIONS ON ACTUAL USE

■ Frequencies

Do not use the (UHF frequency) = (VHF frequency) $\times 3 \pm$ (1 MHz or less) formula to set the frequency. VHF harmonics reduce UHF sensitivity. Other frequency relationships may generate beats that degrade sensitivity, and the TNC circuit beat may also reduce sensitivity.

Harmonics in the HF band may also have VHF frequencies, which can reduce sensitivity.

Also, be careful with interference to your VHF and UHF frequencies by other stations. This could discontinue connection between the Commander and Transporter; the HF transceiver becomes out of your control.

■ Tone Frequency

We recommend you use low frequencies. Using a high tone frequency causes the tone to interfere with HF voice transmissions and adversely affects the S/N ratio. This may appear to the other party to be a beat or interference from another ham radio operator. Tones of 123 Hz or less are unlikely to be transmitted and will improve S/N ratio.

■ HF Band Transmission Output

Using a high-output linear amplifier while using Sky Command II may cause unexpected problems.

■ CW Mode

Pressing [PTT] in CW mode sends a carrier signal, but due to the slow response speed, morse code cannot be sent.

■ HF Band Transmission Frequency

If you specify a frequency that does not allow transmission in the HF band and then attempt to send data from the Commander, the Commander will send the data, but it will not be sent on the HF band. When this occurs, no error appears on the Commander.



PC COMMANDS

ABOUT PC COMMANDS

After connecting the TH-D7 to your PC, you can control the TH-D7 by sending commands from your computer. Doing so, you can read data from and write data to the TH-D7 memory.

Use the supplied PG-4W connection cable to connect the TH-D7 and PC. Attach the cable to the COM port (RS232C) of your PC and the PC jack of the TH-D7. Now you can start data communications between the PC and TH-D7.

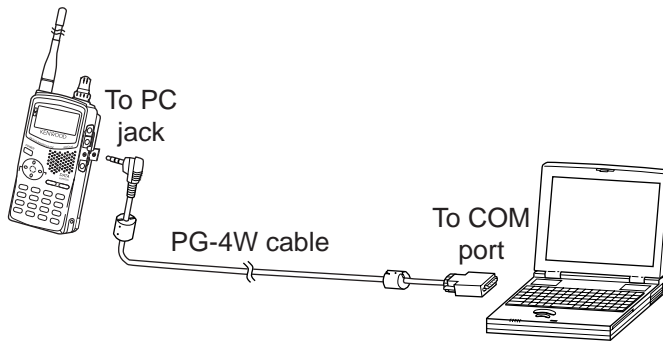

The table below shows the TH-D7 data communications specifications. In accordance with the software used, set up the RS232C serial port.

Transfer method	Serial interface
Transfer speed	9600 bps
Data structure	Character bits: 8 bits Stop bits: 1 bit (Use ASCII data for characters)
Parity	non
Flow control	Soft flow

The easiest way to control the TH-D7 with your personal computer is to use a conventional communications program. However, this is not practical because commands must be entered manually. Programming using BASIC or C language makes operation of the TH-D7 much more comfortable.

If the TH-D7 packet mode is ON, it cannot receive commands. Be sure to turn packet mode OFF.

COMMAND STRUCTURE

Command: FQ 0014400000,0(CR)

- **FQ:** Alphanumeric Command

Alphanumeric commands can include 0 ~ 9 and A ~ Z. Transceivers accept both capital and lowercase letters but will only output commands in capital letters.

- **<space>:** Separator

You must insert a separator (space or ASCII code of 20H) between the alphanumeric command and the parameters. A separator is not necessary when there are no parameters.

- **0014400000,0:** Parameters

Parameters consist of ASCII codes ranging from 20H ~ FFH. You must enter the required amount of digits in each parameter. A comma (,) is used to separate different parameters. Only omit unnecessary parameters or those which do not correspond to your transceiver.

- **(CR):** Terminator

A terminator, carriage return (enter/return or ASCII code of 0DH), represents the end of command. It must be inserted.

- Transceiver Error Messages

?(CR): There is no such alphanumeric command.

N(CR): The command is correct, but your transceiver cannot execute it for some reason.

COMMAND TYPES

Set: Status setup

Read: Request an answer

Answer: Output the status

Example:

To set up a frequency of 144.000 MHz in 5 kHz steps, send the following Set command to the transceiver from your PC:

FQ 0014400000,0

To monitor the displayed frequency, send the Read command:

FQ

When the transceiver receives the command, the following Answer command is sent to your PC from the transceiver:

FQ 0014400000,0



ALPHANUMERIC COMMANDS

Command	Full Name	Function
AI	Auto information	Turns this function ON or OFF. When this function is ON, it will automatically output various answer commands when you change the settings.
AIP	Advanced intercept point	Turns this function ON or OFF, or displays its current status.
AMSG	APRS message	Sets up an APRS message/bulletin, or displays its current message/bulletin.
APO	Auto power off	Turns this function ON or OFF, or displays its current status.
ARL	APRS position limit	Limits the APRS data reception distance, or displays the current setting.
ARO	Auto repeater offset	Turns this function ON or OFF, or displays its current status.
ASC	Automatic simplex checker	Turns this function ON or OFF, or displays its current status.
BAL	Volume balance	Adjusts the volume balance between the A band (upper display area) and B band (lower display area).
BC	Band A & B	Sets up the operation band, or displays its current status.
BCN	APRS beacon	Turns this function ON or OFF, or displays its current status.
BEL	Tone alert	Turns this function ON or OFF, or displays its current status.
BEP	Beep	Turns the beep sound ON or OFF, or displays its current status.
BUF	(Currently displayed data)	Sets up the displayed frequency and related data, or displays its current status.
BY	Busy	Displays the busy status.
CH	Channel display	Turns the channel display ON or OFF, or displays its current status.
CIN	Call channel input	Enters the transceiver's displayed frequency into the CALL channel.

Command	Full Name	Function
CNT	Contrast	Sets the contrast, or displays its current setting.
CR	Read CALL channel	Displays the CALL channel status.
CT	CTCSS	Turns the CTCSS ON or OFF, or displays its current status.
CTD	CTCSS detection	Displays the CTCSS matching and unmatching status.
CTN	CTCSS number	Selects a CTCSS frequency, or displays its current setting.
CW	Write CALL channel	Enters data into the CALL channel.
DL	Dual band	Selects dual or single band mode, or displays its current status.
DM	DTMF Memory	Sets up the DTMF memory, or displays its current status. The DTMF memory is sent while transmitting.
DMN	DTMF memory name	Sets up the DTMF memory name, or displays its current name.
DS	DCD sense	Checks for a busy signal on the non-data band, or displays the current status.
DTB	Data band	Sets up the data transfer band, or displays its current status.
DTX	Beacon transmit method	Sets up the method of transmitting APRS data, or displays the current method.
DUP	Full duplex	Selects duplex or simplex mode, or displays the current setting.
DW	Down	Decreases the frequency or memory channel by steps of one or more.
ELK	Tuning enable	Sets this function to lock or unlock, or displays its current status.
FQ	Frequency	Sets up displayed frequency data, or displays its current setting.



Command	Full Name	Function
GU	GPS receiver	Sets up the GPS receiver you use for APRS, or displays the current status.
ICO	Station icon	Sets up your station icon for use with APRS, or displays its current icon.
ID	Identity	Displays the transceiver name.
LIST	List	Displays the information of the received station while using APRS.
LK	Transceiver lock	Turns the key lock function ON or OFF, or displays its current status.
LMP	Lamp	Turns the continuous light function ON or OFF, or displays its current status.
MAC	My call color	When using SSTV, sets up the color of your station call sign which you superimpose on transmissions, with the VC-H1.
MC	Memory channel	Selects a memory channel number, or displays its current number.
MCL	Memory channel lockout	Turns this function ON or OFF, or displays its current status.
MD	Mode	Sets up the receiving mode, or displays its current status.
MES	Power on message	Sets up the text of this message, or displays its current message.
MIN	Memory input	Stores the transceiver's displayed frequency into memory.
MNA	Memory name	Sets up the text of this name, or displays its current name.
MNF	Memory name frequency	Switches between the memory name and the frequency, or displays its current setting.
MON	Monitor	Turns this function ON or OFF, or displays its current status.
MP	My position	Enters your station's position when you are not using a GPS receiver during APRS compatible data communications.

Command	Full Name	Function
MR	Memory read	Recalls the Memory channel data.
MSH	Memory shift	Transfers the transceiver's displayed memory channel or CALL channel frequency to the VFO.
MW	Memory write	Enters data into the memory channel.
MYC	My call	Enters your call sign for use with APRS.
NSFT	Noise shift	When using a TNC and there is an internal beat, sets up the frequency shift of this function, or displays its current status.
OS	Offset	Sets up the offset frequency, or displays its current status.
PC	Power control	Sets up the transmitting power, or displays the current level.
POSC	Position comment	Sets up the position comment for use with APRS, or displays its current status.
PP	Packet path	During APRS, sets up the packet path when you are using a digipeater.
PT	Pause time	Sets up the DTMF memory pause time, or displays its current setting.
PV	Program VFO	Sets up the frequency of this function, or displays its current setting.
RBN	RX band	Switches the receiving band, or displays the current status.
REV	Reverse	Turns this function ON or OFF, or displays its current status.
RSC	RSV color	When using SSTV, sets up the color of the signal report RSV which you superimpose on transmissions, with the VC-H1.
RSV	RSV	When using SSTV, sets up the Signal Report RSV which you superimpose on transmissions, with the VC-H1.
RX	RX	Switches the transceiver to receive mode.
SC	Scan	Turns the Scan function ON.



Command	Full Name	Function
SCC	Sky command commander call	Sets up your call sign data which is necessary for Sky Command II communications.
SCR	Scan resume	Sets up Scan mode, or displays its current status.
SCT	Sky command	Sets up the call sign data of the transporter that is linked to the commander for Sky Command II communications, or displays its current status.
SFT	Shift	Sets up the shift status, or displays its current status.
SKTN	Sky command	Sets up the Tone frequency for Sky Command II communications, or displays the current value.
SM	Signal meter	Displays the lit number of the S-meter or battery meter.
SMC	SSTV message color	When using SSTV, sets up the color of the message which you superimpose on transmissions, with the VC-H1.
SMSG	SSTV message	When using SSTV, sets up the message which you superimpose on transmissions, with the VC-H1.
SMY	SSTV my call	When using SSTV, sets up your call sign which you superimpose on transmissions, with the VC-H1.
SQ	Squelch level	Sets up the squelch level, or displays its current level.
ST	Step	Sets up the step size, or displays the current size.
STAT	Status text	Sets up the text data that is transmitted with the position data for use with APRS, or displays the current data
SV	Save	Sets up the save function, or displays its current status.
TC/TS	Transceiver control	Turns this function ON or OFF.
TH	Transmit hold	Turns this function ON or OFF after sending a 1750 Hz tone, or displays its current status.
TN	Tone number	Sets up the Tone frequency, or displays its current value.

Command	Full Name	Function
TNC	TNC	Turns the internal TNC ON or OFF, or displays its current status.
TO	Tone	Turns the Tone function ON or OFF, or displays its current status.
TSP	TX speed	Sets up the DTMF memory transmitting speed, or displays its current speed.
TT	TX tone	Adds the 1750 Hz tone to your transmissions.
TX	TX	Switches the transceiver to transmit mode.
TXH	TX hold	Turns this function ON or OFF in order to continue transmitting the DTMF code for 2 seconds, or displays its current status.
TXI	TX interval	Sets up the beacon function interval, or displays its current status.
TXN	TX narrow	Switches to narrow transmission in the VHF band, or displays its current status.
TXS	TX stop	Turns the transmit prohibition function ON or OFF, or displays its current status.
UNIT	Unit	When using APRS, sets up the units, or displays its current status.
UP	Up	Increases the frequency or memory channel by steps of one or more.
UPR	Unprotocol	Sets up the unprotocol for use with APRS, or displays the current setting.
VCS	VC shutter	Sets up the SSTV transmit remote control function, or displays its current status.
VMC	VFO, MR, CALL	Sets up the VFO, MR, and CALL modes, or displays their current settings.
VR	VFO read	Displays the VFO frequency data.
VW	VFO write	Enters VFO frequency data.



COMMAND COMMENTS

- **AI (Auto Information)**

You can turn this function ON or OFF. When this function is ON, it will automatically output various answer commands when you change the settings.

Set: AI [Parameter]

Read: AI

Answer: AI [Parameter]

Parameters:

0: OFF

1: ON

- **AIP (Advanced Intercept Point)**

You can turn this function ON or OFF, or display its current status.

Set: AIP [Parameter]

Read: AIP

Answer: AIP [Parameter]

Parameters:

0: OFF

1: ON

Note: *You can only set up the VHF band.*

- **AMSG (APRS Message)**

You can set up an APRS message/bulliten, or display its current message/bulletin.

Set: AMSG 00,[Target station's call sign],[Message]

Read: AMSG [Read number]

Answer: AMSG [Message category],[Receiving station's call sign],[Message],
[Message number]

Parameters:

Read:

01 ~ 16 : Displayed number selection for a message or bulletin.

Target station's call sign:

9 character ASCII code which can consist of A ~ Z, 0 ~ 9 and -.

Receiving station's call sign:

Consists of A ~ Z, 0 ~ 9, and -.

Message:

45 Character ASCII code

You can use 20H ~ 7FH from Character list 1.

Message category:

Message addressed to receiving stations.

0 ~ 5: The number of times remaining for a message to be transmitted

*: An acknowledgment has been received

Message addressed to you:

M: A message addressed to you

B: A bulletin

Message number:

5 character (maximum) ASCII code (A ~ Z, 0 ~ 9)

Note: To set up a bulletin, enter "BLN#" (# is an ASCII character in the range of A ~ Z and 0 ~ 9) as the target station's call sign.



- **APO (Auto Power Off)**

You can turn this function ON or OFF, or display its current status.

Set: APO [Time]

Read: APO

Answer: APO [Time],[APO status]

Parameters:

Time:

0: OFF

1: 30

2: 60

APO status (only when APO is ON):

0: More than one minute before power off

1: Within one minute of power off

- **ARL (APRS Position Limit)**

You can limit the APRS data reception distance, or display the current setting.

Set: ARL [Data]

Read: ARL

Answer: ARL [Data]

Parameters:

Data:

4 byte ASCII code, ranging from 0000 ~ 2500 in steps of 10.

Note:

- ◆ You can select your desired units as either kilometers (Km) or miles (Mile) by using the UNIT command.
- ◆ To turn this function OFF (no range limits), select "0000".

- **ARO (Auto Repeater Offset)**

You can turn this function ON or OFF, or display its current status.

Set: ARO [Parameter]

Read: ARO

Answer: ARO [Parameter]

Parameters:

0: OFF

1: ON

- **ASC (Automatic Simplex Checker)**

You can turn this function ON or OFF, or display its current status.

Set: ASC [Band selection],[Setting]

Read: ASC [Band selection]

Answer: ASC [Band selection],[Setting],[Check results]

Parameters:

Band selection:

0: A Band

1: B Band

Setting:

0: OFF

1: ON

Check results (only when ASC is ON):

0: Communication is not possible

1: Communication is possible



- **BAL (Volume Balance)**

You can adjust the volume balance between the A band (upper display area) and B band (lower display area).

Set: BAL [Balance]

Read: BAL

Answer: BAL [Balance]

Parameters:

Balance:

0: B band is muted

1: B band is attenuated

2: Balanced

3: A band is attenuated

4: A band is muted

- **BC (Band A & B)**

You can set up the operation band, or display its current status.

Set: BC [Band selection]

Read: BC

Answer: BC [Band selection]

Parameters:

Band selection:

0: A Band

1: B Band

- **BCN (APRS Beacon)**

You can turn this function ON or OFF, or display its current status.

Set: BCN [Parameter]

Read: BCN

Answer: BCN 0

Parameters:

0: Not transmitting

1: Transmit APRS position data (only 1 time)

Note:

- ◆ *The answer is always "BCN 0".*
- ◆ *You cannot set up this command while in packet mode.*

- **BEL (Tone Alert)**

You can turn this function ON or OFF, or display its current status.

Set: BEL [Band selection],[Setting]

Read: BEL [Band selection]

Answer: BEL [Band selection],[Setting],[Status]

Parameters:

Band selection:

0: A Band

1: B Band

Setting:

0: OFF

1: ON

Status:

1: A signal has been received and the timer is counting.



Shift:

0: Simplex

1: + offset direction

2: - offset direction

3: -7.6 MHz offset direction

Reverse:

0: OFF

1: ON

Tone:

0: OFF

1: ON

CTCSS:

0: OFF

1: ON

Tone frequency:

2 bytes of data in the range of 01, 03 ~ 39. (Refer to TN.)

CTCSS Frequency:

2 bytes of data in the range of 01, 03 ~ 39. (Refer to CTN.)

Offset (Hz):

9 bytes of ASCII Data ranging from 000000000 ~ 029950000 in steps of 50 kHz.

FM/ AM:

0: FM

1: AM

Note:

- ◆ *If the transceiver is in VFO mode, the VFO frequency and other VFO related data is also changed.*
- ◆ *If the transceiver is in MR or CALL mode, only the displayed frequencies are changed. The MR and CALL data is not changed.*
- ◆ *Only the TH-D7E supports the -7.6 MHz offset direction.*
- ◆ *Only the TH-D7A supports the FM/ AM parameters.*

- **BY (Busy)**

You can display the busy status.

Set:

Read: BY [Band selection]

Answer: BY [Band selection],[Status]

Parameters:

Band selection:

0: A Band

1: B Band

Status:

0: Not busy

1: Busy

- **CH (Channel Display)**

You can turn the channel display ON or OFF, or display its current status.

Set: CH [Parameter]

Read: CH

Answer: CH [Parameter]

Parameters:

0: OFF

1: ON

Note: *If no channels have stored data, the transceiver will send a "N" error message.*



- **CIN (Call Channel Input)**

You can enter the transceiver's displayed frequency into the CALL channel.

Set: CIN

Read:

Answer: CIN

Parameters:

No parameters are required.

Note:

- ◆ *This command will only function in the operating band.*
- ◆ *Only the TH-D7A supports this command.*

- **CNT (Contrast)**

You can set the contrast, or display its current setting.

Set: CNT [Contrast level]

Read: CNT

Answer: CNT [Contrast level]

Parameters:

Contrast level:

01 ~ 16: 1 is minimum; 16 is maximum

- **CR (Read CALL Channel)**

You can display the CALL channel status.

Set:

Read: CR [Band selection],[Split selection]

Answer: CR [Band selection],[Split selection],[Frequency],[Frequency step size],[Shift],[Reverse],[Tone],[CTCSS],[Tone frequency],[CTCSS frequency],[Offset],[FM/ AM]

Parameters:

Band selection:

0: VHF Band

1: UHF Band

Split selection:

0: Select reception side data

1: Select transmission side data

Frequency (Hz):

11 bytes of data in the range of the selectable frequencies in each band.

Frequency step size (kHz):

0: 5	5: 20
1: 6.25	6: 25
2: 10	7: 30
3: 12.5	8: 50
4: 15	9: 100

Shift:

0: Simplex

1: + offset direction

2: - offset direction

3: -7.6 MHz offset direction

Reverse:

0: OFF

1: ON

Tone:

0: OFF

1: ON

CTCSS:

0: OFF

1: ON

Tone frequency:

2 bytes in the range of 01, 03 ~ 39. (Refer to TN.)

CTCSS FREQUENCY:

2 bytes in the range of 01, 03 ~ 39. (Refer to CTN.)

Offset (Hz):

9 bytes of ASCII data ranging from 000000000 ~ 029950000 Hz in 50 kHz steps.

FM/ AM:

0: FM

1: AM

Note:

- ◆ In split selection, if transmission side data is selected but not entered, a "N" error occurs.
- ◆ Only the TH-D7E supports the -7.6 MHz offset direction.
- ◆ Only the TH-D7A supports the FM/ AM parameters.

- **CT (CTCSS)**

You can turn the CTCSS ON or OFF, or display its current status.

Set: CT [Parameter]

Read: CT

Answer: CT [Parameter]

Parameters:

0: OFF

1: ON

Note: You can only set up or view when on the operating band.

- **CTD (CTCSS Detection)**

You can display the CTCSS matching and unmatching status.

Set:

Read: CTD [Band selection]

Answer: CTD [Band selection],[Status]

Parameters:

Band selection:

0: A Band

1: B Band

Status:

0: The CTCSS frequencies match

1: The CTCSS frequencies do not match

Note: If CTCSS is OFF, the transceiver sends back a "N" error message.



- **CTN (CCSS Number)**

You can select a CTCSS frequency, or display its current setting.

Set: CTN [CTCSS number]

Read: CTN

Answer: CTN [CTCSS number]

Parameters:

CTCSS number:

01	67.0 Hz	10	91.5 Hz	18	118.8 Hz	26	156.7 Hz	34	210.7 Hz
03	71.9 Hz	11	94.8 Hz	19	123.0 Hz	27	162.2 Hz	35	218.1 Hz
04	74.4 Hz	12	97.4 Hz	20	127.0 Hz	28	167.9 Hz	36	225.7 Hz
05	77.0 Hz	13	100.0 Hz	21	131.8 Hz	29	173.8 Hz	37	233.6 Hz
06	79.7 Hz	14	103.5 Hz	22	136.5 Hz	30	179.9 Hz	38	241.8 Hz
07	82.5 Hz	15	107.2 Hz	23	141.3 Hz	31	186.2 Hz	39	250.3 Hz
08	85.4 Hz	16	110.9 Hz	24	146.2 Hz	32	192.8 Hz		
09	88.5 Hz	17	114.8 Hz	25	151.4 Hz	33	203.5 Hz		

Note: If CTCSS is OFF, the transceiver sends back a "N" error message.

Tone:

0:OFF

1: ON

CTCSS:

0: OFF

1: ON

Tone frequency:

2 bytes in the range of 01, 03 ~ 39. (Refer to TN.)

CTCSS FREQUENCY:

2 bytes in the range of 01, 03 ~ 39. (Refer to CTN.)

Offset (Hz):

9 bytes of ASCII data ranging from 000000000 ~ 029950000 Hz in 50 kHz steps.

FM/ AM:

0: FM

1: AM

Note:

- ◆ *In split selection, when you enter data in the transmission side, you will transmit the "CW [Band selection],[Split selection],[Frequency],[Frequency step size]" command.*
- ◆ *The displayed frequency does not change.*
- ◆ *In split selection, if transmission side data is selected but not entered, a "N" error occurs.*
- ◆ *Only the TH-D7E supports the -7.6 MHz offset direction.*
- ◆ *Only the TH-D7A supports the FM/ AM parameters.*

• **DL (Dual Band)**

You can select dual or single band mode, or display its current status.

Set: DL [Parameter]

Read: DL

Answer: DL [Parameter]

Parameters:

0: Single Band Mode

1: Dual Band Mode

- **DM (DTMF Memory)**

You can set up the DTMF memory, or display its current status. The DTMF memory is sent while transmitting.

Set: DM [Number],[DTMF code]

Read: DM [Number]

Answer: DM [Number],[DTMF code]

Parameters:

Number:

00 ~ 09: DTMF memory number

DTMF code:

16 characters consisting of 0 ~ 9, A, B, C, D, E, and F.

Note:

- ◆ While transmitting, you can send the DTMF memory by using "DM [Number]".
- ◆ To erase the DTMF memory of the selected channel, use "DM [Number],".

- **DMN (DTMF Memory Name)**

You can set up the DTMF memory name, or display its current name.

Set: DMN [Number],[DTMF memory name]

Read: DMN [Number]

Answer: DMN [Number],[DTMF memory name]

Parameters:

Number:

00 ~ 09: DTMF memory number

DTMF memory name:

You can enter up to 8 characters from Character list 1, in the range of 20 ~ 7F, 8A, 8C, 9A, 9C, 9F, and C0 ~ FF (excluding D7, DE, F7, and FE), to use as the DTMF memory name.

Note: To erase the DTMF memory name of the selected channel, use "DMN [Number],".



- **DS (DCD Sense)**

You can check for a busy signal on the non-data band, or display the current status.

Set: DS [Mode]

Read: DS

Answer: DS [Mode]

Parameters:

Mode:

0: Only Data Band

1: Both Bands

- **DTB (Data Band)**

You can set up the data transfer band, or display its current status.

Set: DTB [Band selection]

Read: DTB

Answer: DTB [Band selection]

Parameters:

Band selection:

0: A Band

1: B Band

- **DTX (Beacon Transmit Method)**

You can set up the method of transmitting APRS data, or display the current method.

Set: DTX [Setting]

Read: DTX

Answer: DTX [Setting]

Parameters:

Setting:

0: Manual

1: PTT

2: Auto

- **DUP (Full Duplex)**

You can select duplex or simplex mode, or display the current setting.

Set: DUP [Parameter]

Read: DUP

Answer: DUP [Parameter]

Parameters:

0: OFF

1: ON

Note: If you are using VxV or single band mode, the transceiver will send back a "N" error message.

- **DW (Down)**

You can decrease the frequency or memory channel by steps of one or more.

Set: DW [Step size]

Read:

Answer: DW [Step size]

Parameters:

Step size:

01 ~ 99

Note: To decrease by 1 step, use DW.

- **ELK (Tuning Enable)**

You can set this function to lock or unlock, or display its current status.

Set: ELK [Parameter]

Read: ELK

Answer: ELK [Parameter]

Parameters:

0: OFF

1: ON

Note: This function can only be used while the transceiver is locked.



- **FQ (Frequency)**

You can set up displayed frequency data, or display its current setting.

Set: FQ [Frequency],[Frequency step size]

Read: FQ

Answer: FQ [Frequency],[Frequency step size]

Parameters:

Frequency:

11 bytes of data in the range of the selectable frequencies in each band.

Frequency step size (kHz):

0: 5	5: 20
1: 6.25	6: 25
2: 10	7: 30
3: 12.5	8: 50
4: 15	9: 100

Note:

- ◆ *After setting the frequency, the displayed frequency changes.*
- ◆ *When in MR mode, the display changes, but the data remains the same.*
- ◆ *When in CALL mode, the display changes, but the data remains the same. (Only the TH-D7A supports this function.)*
- ◆ *When in VFO mode, all data is changed.*
- ◆ *The frequency changes according to the step frequency.*

- **GU (GPS Unit)**

You can set up the GPS receiver you use for APRS, or display the current status.

Set: GU [Type]

Read: GU

Answer: GU [Type]

Parameters:

Type:

- 0: Not used
- 1: NMEA

- **ICO (Icon)**

You can set up your station icon for use with APRS, or display its current icon.

Set: ICO [Mode],[Data]

Read: ICO

Answer: ICO [Mode],[Data]

Parameters:

Mode:

0: graphic icon

1: others

Data:

When Mode is "0" (1 byte Data), you can use 0 ~ 9, and A ~ E (refer to Character List 2)

When Mode is "1" (2 byte Data), and the first byte of data is either "/" or "\", you can select a character from 20 ~ 7E (refer to Character List 1) for the second byte. When the first byte of data is 1 ~ 9 and A ~ Z, you can select a character from "^", "s", ">", "n", "u", "v", "#", "&", "_", "W", "I", "O", or "A" for the second byte.

- **ID (Identity)**

You can display the transceiver name.

Set:

Read: ID

Answer: ID TH-D7

Parameters:

No parameters are required.



- **LIST (List)**

You can display the information of the received station while using APRS.

Set:

Read: LIST [CH]

Answer: LIST [CH],[Call sign],[Latitude & Longitude],[Icon],[Position comment],[Category],[Overlay character],[Status text],[Information data]

Parameters:

CH:

2 byte ASCII Data ranging from 01 ~ 40.

Call sign:

9 ASCII Characters (maximum)

Latitude & Longitude:

A total of 17 bytes of Data

00°00.000 ~ 90°59.990: Latitude data (consists of 7 bytes of data)

0: North latitude

1: South latitude

000°00.000 ~ 180°59.990: Longitude data (consists of 8 bytes of data)

0: East Longitude

1: West Longitude

Icon:

For other icons, use 2 bytes of ASCII Data.

The first byte of data is "/" or "\". The second byte of data is any character from 20 ~ 7E, listed in Character List 1.

Position comment:

1 byte of Data consisting of the following

- 0: Off Duty
- 1: Enroute
- 2: In Service
- 3: Returning
- 4: Committed
- 5: Special
- 6: PRIORITY
- 7: EMERGENCY !

Category:

1 byte of Data consisting of the following

- 0: normal position data
- 1: WX data
- 2: moving station data
- 3: object data
- 4: fixed station data (PHGD)
- 5: raw GPS data with xyz icon
- 6: raw GPS data (GPRMC)
- 7: fixed station data (compressed format)

Overlay character:

1 byte of Data

Status text:

20 ASCII characters (maximum).

Information data:

12 ASCII characters (maximum)

This information is data specified by [Category].



- **LK (Lock)**

You can turn the key lock function ON or OFF, or display its current status.

Set: LK [Parameter]

Read: LK

Answer: LK [Parameter]

Parameters:

0: OFF

1: ON

- **LMP (Lamp)**

You can turn the continuous light function ON or OFF, or display its current status.

Set: LMP [Parameter]

Read: LMP

Answer: LMP [Parameter]

Parameters:

0: OFF

1: ON

- **MAC (My Call Color)**

When using SSTV, you can set up the color of your station call sign which you superimpose on transmissions, with the VC-H1.

Set: MAC [Color selection]

Read: MAC

Answer: MAC [Color selection]

Parameters:

Color selection:

0: Black

1: Blue

2: Red

3: Magenta

4: Green

5: Cyan

6: Yellow

7: White

- **MC (Memory Channel)**

You can select a memory channel number, or display its current number.

Set: MC [Band selection],[Channel number]

Read: MC [Band selection]

Answer: MC [Band selection],[Channel number]

Parameters:

Band selection:

0: A Band

1: B Band

Channel number:

The memory channel is selected using 3 bytes of ASCII data ranging from 000 ~ 199. Program Scan Memory is selected using ASCII data ranging from L0 ~ L9 and U0 ~ U9.

Note: If you do not use MR mode, an error will occur.



- **MCL (Memory Channel Lockout)**

You can turn this function ON or OFF, or display its current status.

Set: MCL [Band selection],[Setting]

Read: MCL [Band selection]

Answer: MCL [Band selection],[Setting]

Parameters:

Band selection:

0: A Band

1: B Band

Setting:

0: OFF

1: ON

Note:

- ◆ If you do not use MR mode, an error will occur.
- ◆ When both the A and B band display the same memory channel, an error will occur.

- **MD (Mode)**

You can set up the receiving mode, or display its current status.

Set: MD [Mode]

Read: MD

Answer: MD [Mode]

Parameters:

Mode:

0: FM

1: AM

Note:

- ◆ Only the TH-D7A supports this command.
- ◆ You can only set up this mode in the 118 MHz band.

- **MES (Power ON Message)**

You can set up the text of this message, or display its current message.

Set: MES [Message text data]

Read: MES

Answer: MES [Message text data]

Parameters:

Message text data:

8 ASCII characters (maximum).

You can use up to 8 characters from Character Table 1: 20 ~ 7F, 8A, 8C, 9A, 9C, 9F, and C0 ~ FF (excluding D7, DE, F7 and FE).

Note: To clear the message text data, use "MES_".

- **MIN (Memory Input)**

You can store the transceiver's displayed frequency into memory.

Set: MIN [Channel number]

Read:

Answer: MIN

Parameters:

Channel number:

3 digits ranging from 000 ~ 199.



- **MNA (Memory Name)**

You can set up the text of this name, or display its current name.

Set: MNA 0,[Channel number],[Text data]

Read: MNA 0,[Channel number]

Answer: MNA 0,[Channel number],[Text data]

Parameters:

Channel number:

000 ~ 199

The Program Scan Memory range is L0 ~ L9 and U0 ~ U9.

Text data:

You can use a maximum of 8 bytes of ASCII Code from Character List 1, in the range of 20 ~ 7F, 8A, 8C, 9A, 9C, 9F, and C0 ~ FF (excluding D7, DE, F7 or FE).

Note:

- ◆ To erase a memory name, use "MNA [Band selection],[Channel number],".
- ◆ You cannot revise the display, even after setting up the memory name.

- **MNF (Memory Name Frequency)**

You can switch between the memory name and the frequency, or display its current setting.

Set: MNF [Parameter]

Read: MNF

Answer: MNF [Parameter]

Parameters:

0: Name

1: Frequency

Note: If you do not use MR mode, an error will occur.

- **MON (Monitor)**

You can turn this function ON or OFF, or display its current status.

Set: MON [Parameter]

Read: MON

Answer: MON [Parameter]

Parameters:

0:OFF

1:ON

Note:

- ◆ You can only set up the operating band.
- ◆ If Monitor and Duplex are ON while transmitting, only the band not being operated will be monitored.

- **MP (My Position)**

You can enter your station's position when you are not using a GPS receiver during APRS compatible data communications.

Set: MP [Data]

Read: MP

Answer: MP [Data]

Parameters:

Data:

00°00.000 ~ 90°59.990: Latitude data (consists of 7 bytes)

0: North Latitude

1: South Latitude

000°00.000 ~ 180°59.990: Longitude data (consists of 8 bytes)

0: East Longitude

1: West Longitude



Tone:

0: OFF

1: ON

CTCSS:

0: OFF

1: ON

Tone frequency:

2 bytes of data from 01, 03 ~ 39. (Refer to TN.)

CTCSS frequency:

2 bytes of data from 01, 03 ~ 39 (Refer to TNC.)

Offset:

9 bytes of ASCII Data from 000000000 Hz ~ 029950000 Hz, in 50 kHz steps.

FM/ AM:

0: FM

1: AM

Lockout:

0: OFF

1: ON

Note:

- ◆ Only the TH-D7E supports the -7.6 MHz offset direction.
- ◆ Only the TH-D7A supports the FM/ AM parameter.

• MSH (Memory Shift)

You can transfer the transceiver's displayed memory channel or CALL channel frequency to the VFO.

Set: MSH

Read:

Answer: MSH

Parameters:

No parameters are required.

Note:

- ◆ You can only set up the operation band.
- ◆ When you are using VFO mode, a "N" error will occur.



• **MW (Memory Write)**

You can enter data into the memory channel.

Set: MW 0,[Split selection],[Channel number],[Frequency],[Frequency step size],[Shift],[Reverse],[Tone],[CTCSS],[Tone frequency],[CTCSS frequency],[Offset],[FM/ AM],[Lockout]

Read:o

Answer: MW

Parameters:

Split selection:

0: Select Data on the transceiver side.

1: Select Data on the transmitter side.

Channel number:

Memory channels are ASCII Data ranging from 000 ~ 199.

Program Scan memory is ASCII Data ranging from L0 ~ L9 and U0 ~ U9.

Frequency:

11 bytes of data in the range of the selectable frequencies in each band.

Frequency step size (kHz):

- | | |
|---------|--------|
| 0: 5 | 5: 20 |
| 1: 6.25 | 6: 25 |
| 2: 10 | 7: 30 |
| 3: 12.5 | 8: 50 |
| 4: 15 | 9: 100 |

Shift:

0: Simplex

1: + offset direction

2: - offset direction

3: -7.6 MHz offset direction

Reverse:

0: OFF

1: ON

Tone:

0: OFF

1: ON

CTCSS:

0: OFF

1: ON

Tone frequency:

2 bytes of data between 01, 03 ~ 39. (Refer to TN.)

CTCSS frequency:

2 bytes of data between 01, 03 ~ 39. (Refer to CTN.)

Offset:

9 bytes of ASCII Data between 000000000 Hz ~ 029950000 Hz in 50 kHz steps.

FM/ AM:

0: FM

1: AM

Lockout:

0: OFF

1: ON

Note:

- ◆ To enter data into the transmitter side with Split selection, use "MW [Band selection],[Split selection],[Frequency],[Frequency step size]".
- ◆ Only the TH-D7E supports the -7.6 MHz offset direction.
- ◆ Only the TH-D7A supports the FM/ AM parameter. Use the parameter "0" for the TH-D7E.



- **MYC (My Call)**

You can enter your call sign for use with APRS.

Set: MYC [Text data]

Read: MYC

Answer: MYC [Text data]

Parameters:

Text data:

A ~ Z, 0 ~ 9, and -.

Note:

- ◆ *You can enter a maximum of 9 characters.*
- ◆ *You cannot set up a call sign with inappropriate (or inadequate) characters. Use the following examples as a guide:*
JA1YKXZ When using only alphanumeric characters, you can only enter a maximum 6 characters.
JA1-YKX-2 You cannot enter more than 2 hyphens.
-JA1YKX You cannot start your call sign with a hyphen
JA1YKX-19 You can only enter characters between 00 and 15 after a hyphen.

- **NSFT (Noise Shift)**

When using a TNC and there is an internal beat, you can set up the frequency shift of this function, or display its current status.

Set: NSFT [Data]

Read: NSFT

Answer: NSFT [Data]

Parameters:

Data:

0: normal

1: upper

Note: *When the TNC power is ON, the operation will perform the way you set it.*

- **OS (Offset)**

You can set up the offset frequency, or display its current status.

Set: OS [Offset]

Read: OS

Answer: OS [Offset]

Parameters:

Offset:

9 bytes of ASCII Data between 000000000 Hz ~ 029950000 Hz in steps of 50 kHz.

Note: You can only set up or view the operation band.

- **PC (Power Control)**

You can set up the transmitting power, or display the current level.

Set: PC [Band selection],[Power]

Read: PC [Band selection]

Answer: PC [Band selection],[Power]

Parameters:

Band selection:

0: A band

1: B band

Power:

0: High

2: Low

3: EL



- **POSC (Position Comment)**

You can set up the position comment for use with APRS, or display its current status.

Set: POSC [Message number]

Read: POSC

Answer: POSC [Message number]

Parameters:

Message number:

0: Off Duty

1: Enroute

2: In Service

3: Returning

4: Committed

5: Special

6: PRIORITY

7: EMERGENCY !

- **PP (Packet Path)**

During APRS, you can set up the packet path when you are using a digipeater.

Set: PP [Path]

Read: PP

Answer: PP [Path]

Parameters:

Path:

A ~ Z, 0 ~ 9, -, and ,.

Note:

- ◆ You can enter a maximum of 32 characters.
- ◆ To clear the packet path, use "PP_".

- **PT (Pause Time)**

You can set up the DTMF memory pause time, or display its current setting.

Set: PT [Pause time]

Read: PT

Answer: PT [Pause time]

Parameters:

Pause time (milliseconds):

0: 100

1: 250

2: 500

3: 750

4: 1000

5: 1500

6: 2000

- **PV (Program VFO)**

You can set up the frequency of this function, or display its current setting.

Set: PV [VFO selection],[Upper limit frequency],[Lower limit frequency]

Read: PV [VFO selection]

Answer: PV [VFO selection],[Upper limit frequency],[Lower limit frequency]

Parameters:

VFO selection:

1: 118 VFO

2: 144 VFO

3: S-144 VFO

6: 440 VFO

Upper and lower frequencies limits are 5 bytes of ASCII data measured in MHz.

Note:

- ◆ *When you enter a command of PV 2,00144,00145, you will use 144.000 MHz to 145.995 MHz.*
- ◆ *Only the TH-D7A supports the 118 VFO parameter.*



- **RBN (RX Band)**

You can switch the receiving band, or display the current status.

Set: RBN [Receiving band]

Read: RBN

Answer: RBN [Receiving band]

Parameters:

Receiving band selection:

1: 118 VFO

2: 144 VFO

3: S-144 VFO

6: 440 VFO

Note:

- ◆ You can only set up or view the operating band.
- ◆ When you use a mode other than VFO mode, a "N" error will occur.
- ◆ Only the TH-D7A supports the 118 VFO parameter.

- **REV (Reverse)**

You can turn this function ON or OFF, or display its current status.

Set: REV [Parameter]

Read: REV

Answer: REV [Parameter]

Parameters:

0: OFF

1: ON

Note: You can only set up or view from the operating band.

- **RSC (RSV Color)**

When using SSTV, you can set up the color of the signal report RSV which you superimpose on transmissions, with the VC-H1.

Set: RSC [Color selection]

Read: RSC

Answer: RSC [Color selection]

Parameters:

Color selection:

0: Black

1: Blue

2: Red

3: Magenta

4: Green

5: Cyan

6: Yellow

7: White

- **RSV (RSV)**

When using SSTV, you can set up the Signal Report RSV which you superimpose on transmissions, with the VC-H1.

Set: RSV [Text data]

Read: RSV

Answer: RSV [Text data]

Parameters:

Text data:

A ~ Z, 0 ~ 9, -, /, !, ?, and a space

Note:

- ◆ *The maximum characters you can enter is 10.*
- ◆ *To clear the Signal Report, use "RSV_".*



- **RX (RX)**

You can switch the transceiver to receive mode.

Set: RX

Read:

Answer: RX

Parameters:

No parameters are required.

Note: You can only set up the operating band.

- **SC (Scan)**

You can turn the Scan function ON.

Set: SC [Parameter]

Read:

Answer: SC [Parameter]

Parameters:

1: ON

2: MHz Scan ON

Note:

- ◆ You can only set up the operating band.
- ◆ In VFO mode, using a parameter of "1" will activate Band or Program Scan. In MR mode, "1" will activate Memory Scan. In Call mode, "1" will activate Call Scan.
- ◆ MHz scan will only operate in VFO mode.
- ◆ When you enter any command other than SC, scanning will stop.
- ◆ The TH-D7E does not support Call Scan.

- **SCC (Sky Command Commander Call)**

You can set up your call sign data which is necessary for Sky Command II communications.

Set: SCC [Text data]

Read: SCC

Answer: SCC [Text data]

Parameters:

Text data:

A ~ Z, 0 ~ 9, and -.

Note:

- ◆ You can use a maximum of 9 characters
- ◆ Only the TH-D7A supports this command.

- **SCR (Scan Resume)**

You can set up Scan mode, or display its current status.

Set: SCR [Setting]

Read: SCR

Answer: SCR [Setting]

Parameters:

Setting:

0: Time operated

1: Carrier operated

2: Seek operated



- **SCT (Sky Command)**

You can set up the call sign data of the transporter that is linked to the commander for Sky Command II communications, or display its current status.

Set: SCT [Text data]

Read: SCT

Answer: SCT [Text data]

Parameters:

Text data:

A ~ Z, 0 ~ 9, and -.

Note:

- ◆ You can enter a maximum of 9 characters.
- ◆ Only the TH-D7A supports this function.

- **SFT (Shift)**

You can set up the shift status, or display its current status.

Set: SFT [Shift selection]

Read: SFT

Answer: SFT [Shift selection]

Parameters:

Shift selection:

0: simplex

1: + offset direction

2: - offset direction

3: -7.6 MHz offset direction

Note:

- ◆ You can only set up and view the operating band.
- ◆ Only the TH-D7E supports the -7.6 MHz offset direction.

- **SKTN (Sky Command)**

You can set up the Tone frequency for Sky Command II communications, or display the current value.

Set: SKTN [Tone number]

Read: SKTN

Answer: SKTN [Tone number]

Parameters:

01, 03 ~ 39 (Refer to TN.)

Note: Only the TH-D7A supports this command.

- **SM (Signal Meter)**

You can display the lit number of the S-meter or battery meter.

Set:

Read: SM

Answer: SM [Band selection],[Lit number]

Parameters:

Band selection:

0: A Band

1: B Band

Lit number:

00 ~ 05



- **SMC (SSTV Message Color)**

When using SSTV, you can set up the color of the message which you superimpose on transmissions, with the VC-H1.

Set: SMC [Color selection]

Read: SMC

Answer: SMC [Color selection]

Parameters:

Color selection:

0: Black

1: Blue

2: Red

3: Magenta

4: Green

5: Cyan

6: Yellow

7: White

- **SMSG (SSTV Message)**

When using SSTV, you can set up the message which you superimpose on transmissions, with the VC-H1.

Set: SMSG [Message text data]

Read: SMSG

Answer: SMSG [Message text data]

Parameters:

Message text data:

9 bytes of ASCII Data ranging from A ~ Z, 0 ~ 9, -, /, !, ?, and a space.

Note: To clear the message, use "SMSG_".



- **SMY (SSTV My Call)**

When using SSTV, you can set up your call sign which you superimpose on transmissions, with the VC-H1.

Set: SMY [Text data]

Read: SMY

Answer: SMY [Text data]

Parameters:

Text data:

8 bytes of ASCII Data ranging from A ~ Z, 0 ~ 9, /, -, !, ?, and a space.

Note: To clear the call sign, use "SMY_".

- **SQ (Squelch Level)**

You can set up the squelch level, or display its current level.

Set: SQ [Band selection],[Squelch level]

Read: SQ [Band selection]

Answer: SQ [Band selection],[Squelch level]

Parameters:

Band selection:

0: A Band

1: B Band

Squelch level:

00 ~ 05



- **ST (Step)**

You can set up the step size, or display the current size.

Set: ST [Step frequency number]

Read: ST

Answer: ST [Step frequency number]

Parameters:

Step frequency number (in kHz):

0: 5	5: 20
1: 6.25	6: 25
2: 10	7: 30
3: 12.5	8: 50
4: 15	9: 100

Note:

- ◆ You can only set up or view the operating band.
- ◆ When you use any mode other than the VFO mode, a "N" error occurs.

- **STAT (Status Text)**

You can set up the text data that is transmitted with the position data for use with APRS, or display the current data.

Set: STST [Message text data]

Read: STST

Answer: STST [Message text data]

Parameters:

Message text data:

You can use a maximum of 20 bytes of ASCII data from the Character List in the range of 20h ~ 7Fh.

Note: To clear the data, use "STAT_".

- **SV (Save)**

You can set up the save function, or display its current status.

Set: SV [Save time]

Read: SV

Answer: SV [Save time]

Parameters:

Save time (in seconds):

0: OFF	5: 1
1: 0.2	6: 2
2: 0.4	7: 3
3: 0.6	8: 4
4: 0.8	9: 5

- **TC/TS (Transceiver Control)**

You can turn this function ON or OFF.

Set: TC [Setting]

Read:

Answer: TS [Mode]

Parameters:

Setting:

0: OFF

1: ON

Mode:

0: Packet Mode

1: Transceiver Control Mode

Note: The TC1 command must be entered using capitalized letters.



- **TH (Transmit Hold)**

You can turn this function ON or OFF after sending a 1750 Hz tone, or display its current status.

Set: TH [Parameter]

Read: TH

Answer: TH [Parameter]

Parameters:

0: OFF

1: ON

Note: Only the TH-D7E supports this command.

• **TN (Tone Number)**

You can set up the Tone frequency, or display its current value.

Set: TN [Tone number]

Read: TN

Answer: TN [Tone number]

Parameters:

Tone number:

01	67.0 Hz	10	91.5 Hz	18	118.8 Hz	26	156.7 Hz	34	210.7 Hz
03	71.9 Hz	11	94.8 Hz	19	123.0 Hz	27	162.2 Hz	35	218.1 Hz
04	74.4 Hz	12	97.4 Hz	20	127.0 Hz	28	167.9 Hz	36	225.7 Hz
05	77.0 Hz	13	100.0 Hz	21	131.8 Hz	29	173.8 Hz	37	233.6 Hz
06	79.7 Hz	14	103.5 Hz	22	136.5 Hz	30	179.9 Hz	38	241.8 Hz
07	82.5 Hz	15	107.2 Hz	23	141.3 Hz	31	186.2 Hz	39	250.3 Hz
08	85.4 Hz	16	110.9 Hz	24	146.2 Hz	32	192.8 Hz		
09	88.5 Hz	17	114.8 Hz	25	151.4 Hz	33	203.5 Hz		

Note: You can only set up or view from the operating mode.



- **TNC (TNC)**

You can turn the internal TNC ON or OFF, or display its current status.

Set: TNC [Parameter]

Read: TNC

Answer: TNC [Parameter]

Parameters:

0: OFF

1: ON

- **TO (Tone)**

You can turn the Tone function ON or OFF, or display its current status.

Set: TO [Parameter]

Read: TO

Answer: TO [Parameter]

Parameters:

0: OFF

1: ON

Note: You can only set up or view from the operating band.

- **TSP (TX Speed)**

You can set up the DTMF memory transmitting speed, or display its current speed.

Set: TSP [Setting]

Read: TSP

Answer: TSP [Setting]

Parameters:

Setting:

0: Slow

1: Fast

- **TT (TX Tone)**

You can add the 1750 Hz tone to your transmissions.

Set: TT

Read:

Answer: TT

Note:

- ◆ You can only set up this function from the operating mode.
- ◆ To enter receive mode, use RX.
- ◆ If you receive a TT command while transmitting, the 1750 Hz tone will be added to the transmission.
- ◆ If you receive a TX command while transmitting with the 1750 Hz tone, the tone will no longer be sent with the transmission.

- **TX (TX)**

You can switch the transceiver to transmit mode.

Set: TX

Answer: TX [Transmission band]

Parameters:

Transmission band:

0: A Band

1: B Band

Note: You can only set up this function from the operating band.

TH-D7E Only:

- ◆ If you receive a TT command while transmitting, the 1750 Hz tone will be added to the transmission.
- ◆ If you receive a TX command while transmitting with the 1750 Hz tone, the tone will no longer be sent with the transmission.

- **TXH (TX Hold)**

You can turn this function ON or OFF in order to continue transmitting the DTMF code for 2 seconds, or display its current status.

Set: TXH [Parameter]

Read: TXH

Answer: TXH [Parameter]

Parameters:

0: OFF

1: ON



- **TXI (TX Interval)**

You can set up the beacon function interval, or display its current status.

Set: TXI [Interval]

Read: TXI

Answer: TXI [Interval]

Parameters:

Interval (in minutes):

0: 0.5

1: 1

2: 2

3: 3

4: 5

5: 10

6: 20

7: 30

- **TXN (TX Narrow)**

You can switch to narrow transmission in the VHF band, or display its current status.

Set: TXN [Parameter]

Read: TXN

Answer: TXN [Parameter]

Parameters:

0: OFF

1: ON

Note: Only the TH-D7E supports this command.



- **TXS (TX Stop)**

You can turn the transmit prohibition function ON or OFF, or display its current status.

Set: TXS [Parameter]

Read: TXS

Answer: TXS [Parameter]

Parameters:

0: OFF

1: ON

- **UNIT (Unit)**

When using APRS, you can set up the units, or display its current status.

Set: UNIT [Unit]

Read: UNIT

Answer: UNIT [Unit]

Parameters:

Unit:

0: mile, °F

1: km, °C

- **UP (Up)**

You can increase the frequency or memory channel by steps of one or more.

Set: UP [Step value]

Read:

Answer: UP [Step value]

Parameters:

Step value:

01 ~ 99

Note: To increase the step by one, use "UP".



- **UPR (Unprotocol)**

You can set up the unprotocol for use with APRS, or display the current setting.

Set: UPR [Data]

Read: UPR

Answer: UPR [Data]

Parameters:

Data:

You can use a maximum of 9 ASCII characters ranging from A ~ Z, 0 ~ 9, and -.

Note: You cannot set up this function while transmitting.

- **VCS (VC Shutter)**

You can set up the SSTV transmit remote control function, or display its current status.

Set: VCS [Parameter]

Read: VCS

Answer: VCS [Parameter]

Parameters:

0: OFF

1: ON

- **VMC (VFO, MR, CALL)**

You can set up the VFO, MR, and CALL modes, or display their current settings.

Set: VMC [Band selection],[VMC number]

Read: VMC [Band selection]

Answer: VMC [Band selection],[VMC number]

Parameters:

Band selection:

0: A Band

1: B Band

VMC number:

0: VFO

2: MR

3: CALL

Note:

- ◆ You can only set up or view this function in the operating band.
- ◆ Only the TH-D7A supports the VMC 3 parameter.

- **VR (VFO Read)**

You can display the VFO frequency data.

Read: VR [VFO selection]

Answer: VR [VFO selection],[Frequency],[Frequency step size],[Shift],[Reverse],[Tone],[CTCSS],[Tone frequency],[CTCSS frequency],[Offset],[FM/ AM]

Parameters:

VFO selection:

1: 118 VFO

2: 144 VFO

3: Sub 144 VFO

6: 430 VFO

Frequency:

11 bytes of data in the range of the selectable frequencies in each band.



Frequency step size (in kHz):

0: 5	5: 20
1: 6.25	6: 25
2: 10	7: 30
3: 12.5	8: 50
4: 15	9: 100

Shift:

0: Simplex

1: + offset direction

2: - offset direction

3: -7.6 MHz offset direction

Reverse:

0: OFF

1: ON

Tone:

0: OFF

1: ON

CTCSS:

0: OFF

1: ON

Tone frequency:

01, 03 ~ 39 (Refer to TN.)

CTCSS Frequency:

01, 03 ~ 39 (Refer to CTN.)

Offset:

9 bytes of ASCII data ranging from 000000000 Hz ~ 029950000 Hz in steps of 50 kHz

FM/ AM:

0: FM

1: AM

Note:

- ◆ Only the TH-D7E supports the -7.6 MHz offset direction.
- ◆ Only the TH-D7A supports the 118 VFO parameter.
- ◆ Only the TH-D7A supports the FM/ AM parameter. Use the Parameter "0" for the TH-D7E.



- **VW (VFO Write)**

You can enter VFO frequency data.

Set: VR [VFO selection],[Frequency],[Frequency step size],[Shift],[Reverse],[Tone],[CTCSS],[Tone frequency],[CTCSS frequency],[Offset],[FM/ AM]

Answer: VR [VFO selection]

Parameters:

VFO selection:

- 1: 118 VFO
- 2: 144 VFO
- 3: Sub 144 VFO
- 6: 430 VFO

Frequency:

11 bytes of data in the range of the selectable frequencies in each band.

Frequency step size (in kHz):

- | | |
|---------|--------|
| 0: 5 | 5: 20 |
| 1: 6.25 | 6: 25 |
| 2: 10 | 7: 30 |
| 3: 12.5 | 8: 50 |
| 4: 15 | 9: 100 |

Shift:

- 0: Simplex
- 1: + offset direction
- 2: - offset direction
- 3: -7.6 MHz offset direction

Reverse:

- 0: OFF
- 1: ON

Tone:

- 0: OFF
- 1: ON

CTCSS:

0: OFF

1: ON

Tone frequency:

01, 03 ~ 39 (Refer to TN.)

CTCSS Frequency:

01, 03 ~ 39 (Refer to CTN.)

Offset:

9 bytes of ASCII data ranging from 000000000 Hz ~ 029950000 Hz in steps of 50 kHz

FM/ AM:

0: FM

1: AM

Note:

- ◆ Only the TH-D7E supports the -7.6 MHz offset direction.
- ◆ Only the TH-D7A supports the 118 VFO parameter.
- ◆ Only the TH-D7A supports the FM/ AM parameter. Use the parameter "0" for the TH-D7E.

CHARACTER LISTS

Character List 1:

		Upper 4 bits													
		2	3	4	5	6	7	8	9	A	B	C	D	E	F
Lower 4 bits	0	sp	0	@	P	'	p					Á	Ð	à	ð
	1	!	1	A	Q	a	q					Ā	Ñ	á	ñ
	2	"	2	B	R	b	r					Ă	Ó	â	ò
	3	#	3	C	S	c	s					Ã	Ô	ã	ó
	4	\$	4	D	T	d	t					Ä	Õ	ä	ö
	5	%	5	E	U	e	u					Å	Ö	å	ü
	6	&	6	F	V	f	v					Æ	Û	æ	ö
	7	'	7	G	W	g	w					Ç		ç	
	8	(8	H	X	h	x					È	Ø	è	ø
	9)	9	I	Y	i	y					É	Ù	é	ù
	A	*	:	J	Z	j	z	Š	š			Ê	Ú	ê	ú
	B	+	;	K	[k	{					Ë	Û	ë	û
	C	,	<	L	\	l		Ĉ	ĉ			Ī	Û	ī	ü
	D	-	=	M]	m	}					Ĵ	ÿ	ĵ	ÿ
	E	.	>	N	^	n	~					İ		î	
	F	/	?	O	_	o				ÿ		Ĭ	ß	ï	ÿ

Character List 2:



TIPS

RECOMMENDED BATTERY SAVER SETUP

The battery saver repeats switching the receive circuit ON and OFF at certain intervals when no signal is present and no key is pressed for approximately 10 seconds.

While you are using APRS or packet communications, you may miss the first packet. In this case you should switch the Battery Save function OFF. However, when it is not important to receive data from other stations, or when you only transmit APRS position data for a long period of time, (hiking, climbing, etc.), you should activate the Battery Save function to allow longer operation time.

WHEN YOU ARE WORRIED ABOUT THE BATTERY LIFE

Operate the transceiver in single-band mode. When you are only using APRS and not voice communication, set the transceiver to single-band operation by switching the non-data band OFF.

HINTS ON ENTERING TEXT

When you enter text in various settings, you can use the 10-key keypad, the multi-scroll key, or the encoder. If you are not familiar with entering characters by using this type of keypad, you will find it easier to use the encoder. However, once you become accustomed to the keypad, the keypad will be easier and faster to use than the encoder.

THE BEEP TONES WHEN APRS DATA IS RECEIVED IS IRRITATING

- Set “BEEP” in AUX in the RADIO menu to KEY+NEW DATA.

In areas where APRS data is frequently received, TH-D7 beep tones may become irritating. Change the setting of “BEEP” in AUX in the RADIO menu.

OFF:	Switch all beep tones off.
KEY:	A beep tone sounds when a key is pressed.
KEY+NEW DATA:	A beep tone sounds when a key is pressed and when new data is received.
ALL:	A beep tone sounds when a key is pressed and when new or duplicate data is received.



THE BEST APRS DATA TRANSMISSION INTERVAL TIME

Walking: 3 minutes

Bicycle: 1 ~ 3 minutes

Car: 0.5 ~ 3 minutes

Fixed station: 20 ~ 30 minutes

Do not transmit data more frequently than necessary. For a mobile station, transmit data at an interval appropriate for notifying others.

DOES NOT TRANSMIT APRS DATA AUTOMATICALLY

- Make sure the TNC function is ON. The display should read TNC, not Packet.
- Check the “MY CALL” setting in the APRS menu. It should read your call sign.
- Check the “DATA TX” setting in the APRS menu. It should read AUTO or PTT.
- Press **[BCON]** to turn the AUTO or PTT function ON.
- Check the “TX INTERVAL” setting in the APRS menu. It may be set too high.
- Check the TNC’s “DCD SENSE” setting in the RADIO menu. If it is set to “BOTH BANDS”, the TNC does not transmit when signals are present on both bands.

APRS DATA IS TRANSMITTED DURING VOICE COMMUNICATION

Set “DCD SENCE” in TNC in the RADIO menu to “BOTH BANDS”.

This selects both the data band and the voice communication band as the signal source for determining whether packet data transmission is permitted.

On the TH-D7, packet data transmission is prohibited during transmission using the **[PTT]** switch and while the busy signal is detected. Packet data transmission is also prohibited for 2 seconds after either of these status ends. If you set “DCD SENSE” to “D BAND ONLY”, the data band is the only source for determining whether the busy signal is detected. The APRS data will be sent while the other party is speaking on the voice band so you cannot hear the incoming voice. When you are using both voice communication and APRS, you should select “BOTH BANDS”.



COPYRIGHTS

Windows is a registered trademark of Microsoft Corporation in the United States and/or other countries.

Adobe and Acrobat are registered trademarks of Adobe Systems Incorporated.

Automatic Packet/ Position Reporting System, APRS, and Mic Encoder are trademarks and/or registered trademarks of Bob Bruninga, WB4APR.

SKY COMMAND is a trademark of **KENWOOD** Corporation.

Other product and company names mentioned herein may be the trademarks of their respective owners.

