

HF&V/UHF ALL MODE TRANSCEIVERS

Product Catalog



The Radio... FTDX 9000

The dynamic environment in which you operate demands that you exercise the most effective command possible over your station.

It's not enough just to receive and transmit.

You need to convert your knowledge and intuition about band conditions and the pile-up behavior into a configuration for your equipment that carries the day.

With the YAESU FTDX 9000, you'll marvel at how your high expectations are exceeded every time you turn on the rig!

This is a radio only YAESU can make.

One that will surprise you and inspire you.

A select radio for a select user...you!



Bold Dignity

"The Best of the Best Just Got Better"



HF/50 MHz Transceiver

FTDX 9000MP (400 W / Class-A 100 W)

Two Pairs of Meters, plus LCD Window; Data Management Unit and Flash Memory Slot Built In Main/Sub Receiver VRF, plus Full Dual Receive Capability
 External 50 V/24 A Switching Regulator Power Supply and Speaker with Audio Filters



HF/50 MHz Transceiver

FTDX 9000D (200 W / Class-A 75 W)

Large TFT, Data Management Unit and Flash Memory Slot Built In, Main/Sub Receiver VRF, plus Full Dual Receive Capability
 Three -Tuning Modules for 160 - 20 M
 50 V/12 A Internal Switching Regulator Power Supply

Supplied Accessories



- FH-2 Remote Control Keypad
- 8 Pin ⇄ Modular Mic Adapter Cable (for MD-200A8X, MD-100A8X, MH-31B8)
- CF Card

Optional Accessories



- SP-9000 Dual Speaker System with Audio Filters for FT DX 9000D
- Size (WHD): 9.7" x 6.5" x 17.2"
 /246 x 165 x 438mm (w/o knobs)



- M-1 Reference Microphone
- Revolutionary dual microphone configuration
- Nine-band graphic equalizer
- Treble Boost Cowling produces a unique tonal texture

The pinnacle of HF Transceiver performance has been reached in the 400-Watt FT DX 9000MP. You'll know that special feeling from the moment your fingertips touch the dial. . .

©Stable, reliable power output from a PA module without peer

The final amplifier stage of the FT DX 9000MP utilizes four SD2931 MOS FET devices in a parallel, push-pull configuration, running at 50 volts to obtain the highest power output in any production Amateur Radio transceiver today. Careful crafting of the bias circuit has resulted in low distortion and reliable performance over long hours of operation. The new heat sink design utilizes an aluminum base 130% larger than that of the 200-Watt versions, and thick copper fins with a high coefficient of thermal conductivity are employed in the cooling system, which has a total volume of 3580 cc.

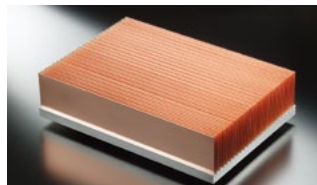

■ Large-area Aluminum Heat Sink

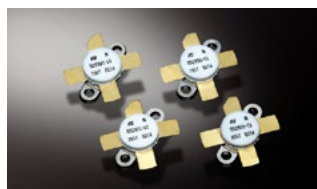

■ 4 x SD2931 MOS FET Devices Produce 400 W of Output Power

©External Power Supply with Dual Speakers and Audio Filters

The FPS-9000H enclosure features two 4" (100 mm) speakers, affording independent audio paths for the Main and Sub receivers audio. The left speaker emits the Main receiver audio, while the right speaker yields the Sub receiver audio. A front panel switch also allows you to combine the audio signals from both receivers for mixed distribution from the two combined speakers. This produces an effective aperture of 8" (200 mm), for outstanding tonal quality!
 (Included in FT DX 9000MP)

The close-in, multi-signal environment. This is where this truly high-quality radio makes the difference.

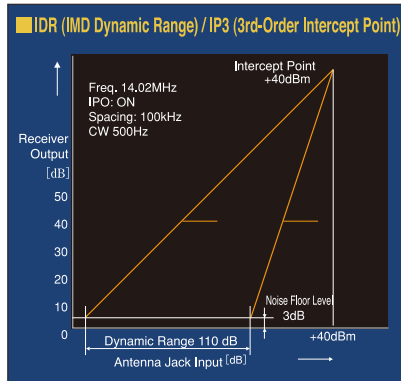

The instant the antenna is connected, you hear a gentle rush, but you immediately notice how low the noise level is. Then you begin to observe weak signals that you probably never knew were there. But this was just the starting point for our research and development team for this elite class HF transceiver for the new decade. Not only did they devote attention to measurement data such as BDR,

IDR, and IP3, which are all in the limelight in the modern HF industry, but they also directed special attention to high performance in the difficult close-in multiple-strong-signal environment by determining the optimum gain allocation for each stage, the purity of all local signals, adequate gain in the mixers, and then followed the research up with exhaustive field tests.

■ The Ultimate Overall Receiver Performance, Achieved through Balanced, High-Level Design

The stress from this hostile RF environment is very harsh on a receiver's RF front end. Our engineering team has recognized the need to improve the overall receiver performance,

balanced at the highest levels, and considering all measurement data (including BDR, IDR, IP3) to form a unified, optimized receiver figure of merit. This important optimization and balance have resulted in a superior receiver with the highest order of performance.

Ultra-Strong RF Front End



■ VRF (Variable RF Filter)

The VRF operates as an RF "preselector" with sufficient "Q" that is significantly narrower than the traditional BPF networks used for decades in solid-state receivers; as a result, much more interference suppression is afforded by the VRF circuit.



■ First IF (40 MHz) 3 kHz Roofing Filter

In the 40 MHz 1st IF, three selectable roofing filters are provided, in bandwidths of 3 kHz, 6 kHz, and 15 kHz, to protect the following stages from strong signals that could degrade dynamic range in the first IF amplifier and subsequent stages. Each roofing filter consists of a four-pole fundamental mode monolithic crystal filter array, the best technique derived from Yaesu's exhaustive testing process.

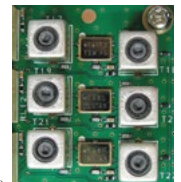

■ Three Selections of IF Roofing Filters

Enjoy the World of YAESU IF DSP, Crafted through Worldwide DX'er Input for Uniquely High Performance and Operability



■ The legendary Yaesu 32-bit floating point IF DSP

The IF DSP system, utilizing a TI TMS320C6713 device, is a high-speed 32-bit floating point circuit designed with a unique objective: to do away with the "digital" sound of many DSP filtering systems, and emulate the "Analog Sound" so familiar and comfortable to HF DX and Contest operators.

- Interference-Fighting WIDTH/SHIFT Controls
- Analog-like DSP CONTOUR Passband Adjustment

■ Interference-Fighting IF Notch and Ultra-Narrow Auto-Notch Beat Reduction Filter
■ Digital Noise Reduction

Capable of reducing atmospheric and other noises using sixteen different unique, original mathematical algorithms, the DSP's Digital Noise Reduction circuitry is a powerful tool for enhancing signal-to-noise ratio on difficult paths.

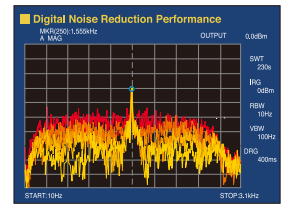

FT DX9000D - The Ultimate, "All Options Installed" Version.
With three μ - Tuning modules, for the pinnacle of receiver performance!

◎ Three μ -Tuning Modules Factory Installed

The D version is factory equipped with all three μ -Tuning modules, covering the 160, 80/40, and 30/20 meter Amateur bands.



◎ Large, Easy-to-Read TFT Display

The wide-screen 6.5" TFT display is an 800 × 480 dot configuration, for high resolution ; the FT DX 9000D is also configured with a



■ Word Clock Feature

rear-panel port allowing connection of an external display.



■ Audio Scope/Oscilloscope Feature

Operability - The Joy of Operating



In the ideal case, you and your transceiver become as one. Besides transmitting your signal, your transceiver must be designed with the most important functions immediately available for observation and adjustment. When fleeting opportunities present themselves, the superior operability of the FT DX 9000 lets you seize the moment.

■ Touch the Main Dial, and You Know the FT DX 9000 is Different. . .

The Main Tuning Dial is a large-diameter (3.2"/81 mm) die-cast aluminum dial directly coupled to the magnetic rotary encoder. Its heavy weight (7 oz./200 g) quality mounting and construction provide a

smooth "flywheel" effect during operation, ideal for quick cruising up and down a band.

■ Multi-Function Dial

To the right of the other two primary control knobs is a "multi-function" knob that serves a number of important purposes. Its most-often-used tasks include VFO-B and Clarifier (offset) tuning, and the large diameter makes precise tuning effortless. Moreover, When operating in the VFO-B mode, this knob may be used for tuning in 100 kHz steps, as well as operating mode selection for VFO-B.



Helping Weak Signals Rise Out of the Interference and Noise!

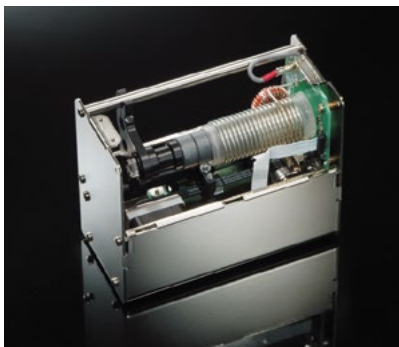

■ New Mu (μ) Narrow-bandwidth High-Q RF Filters Using Large-Diameter (28 mm) Coils

Operation on the low bands, especially 1.8 MHz, frequently involves very strong signals from close-by broadcast stations, with signal voltages much greater than on the high bands due to NVIS propagation and large antenna size. Heretofore no RF filtering system in an Amateur Transceiver was fully equipped to cope with this challenge, but Yaesu's new " μ -Tuning" filter breaks new ground, providing ultra-high-Q RF preselection selectivity on the 14 MHz and lower Amateur bands.

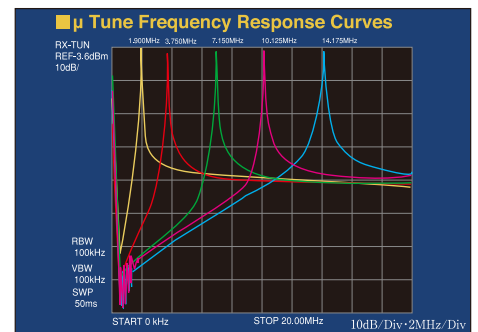

Using an Optional, Large External Personal Computer Monitor Display



When your transceiver has the Data Management Unit installed, but not the internal TFT, you may utilize a large after-market LCD or similar display, if you like, to display the information produced on the TFT. In this case, seven

command keys below the meters on the right side may be used for control functions. The FT DX 9000MP has the data management unit installed at the factory.

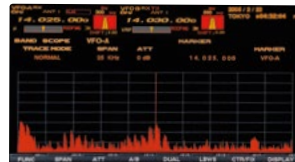

■ Spectrum Scope Display



■ World Clock Display



■ Antenna Bearing Indication using Great Circle Map

■ Swept-Frequency SWR Display

■ Memory Channel List

■ Audio Scope/Oscilloscope Feature

QUADRA SYSTEM

● VL-1000
HF-50 MHz 1 kW Linear Amplifier*
(50 MHz 500 W/USA Version)
Automatic Antenna Tuner Built In

● VP-1000
VL-1000 Power Supply*

RF μ -Tuning Units

● MTU-160
RF μ -Tuning Unit A
For 160 m Band

● MTU-80/40
RF μ -Tuning Unit B
For 80/40 m Band

● MTU-30/20
RF μ -Tuning Unit C
For 30/20 m Band

● SCU-17
USB Interface Unit
(Requires SCU-22)

● SCU-22
Connection Cable

OPTIONS

● TFT-9000
TFT Display Unit

● SP-9000
SP-9000 Dual Speaker System
with Audio Filters

● MH-31B8
Hand Microphone

● M-1
Reference Microphone

● M-100
Dual-Element Microphone

● MD-200A8X
Ultra High fidelity Desktop Microphone

● MD-100A8X
Desktop Microphone

● YH-77STA
Lightweight Stereo Headphone

*USA and Asian versions only

The Answer ...

Equipped with Extra Sharp 6-pole Crystal Roofing Filters

The Premium HF / 50 MHz Transceiver FT DX 5000

The Newly designed 9 MHz 1st IF of the FT DX 5000 main receiver implements sharp 6-pole* crystal roofing filters. *8-pole / 3 kHz

Superior close-in dynamic range affords the serious DX'er the best performance possible.



The New Premium HF/50 MHz 200 W Transceiver



HF/50 MHz 200 W Transceiver

FTDX 5000MP *Limited* 200 W / Class-A 75 W

± 0.05 ppm OCXO included
300 Hz, 600 Hz, and 3 kHz Crystal Roofing Filters included

Supplied Accessories

- FH-2 Remote Control Keypad
Message Keyer, Audio Message Memory Command and Selection



- MH-31 B8 Hand Mic

Optional Accessories

- SM-5000 Station Monitor (Optional for FT DX 5000MP Limited)



Specifications: Speakers : 65 mm (2.55 in) x 25 mm (0.98 in) x 2 sets Audio Output: 1.5 W+1.5 W (@ 8 Ω)

High-Resolution Spectrum Scope with LBWS

You can monitor activity on the VFO-A band. The RF Band Scope function allows you to view activity within a span of 25 kHz, 50 kHz, 100 kHz, 250 kHz, 500 kHz, 1 MHz, or 2.5 MHz. Choose CTR (center) or FIX modes, to limit lower and upper frequencies, and control signal levels with ATT (attenuator) 0, -10, or -20 dB. Additionally, LBWS (Limited Band Width Sweep) function allows you to reduce the bandwidth in order to increase the sweep speed.



- M-1 Reference Microphone

- Revolutionary dual microphone configuration
- Nine-band graphic equalizer
- Treble Boost Cowling produces a unique tonal texture

The Answer ...

Equipped with Extra Sharp Crystal Roofing Filters

© Newly designed sharp Crystal Roofing Filters

Newly designed sharp 6-pole Crystal Roofing Filters produce excellent shape factor for the VFO - A / Main Receiver. They are selectable between 300 Hz, 600 Hz, 3 kHz, 6 kHz, and 15 kHz, and are optimized by mode for best performance. You are prepared to enjoy serious DX operation on today's crowded bands with the incomparable crisp and sharp 300Hz narrow filter!

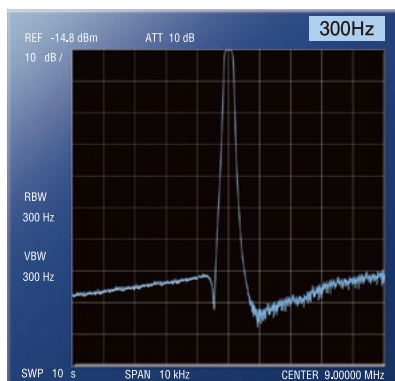

■ Characteristics and frequency response of Roofing Filter (300Hz)

© Enjoy the superb and astonishing IDR 112dB, IP3 +40dBm

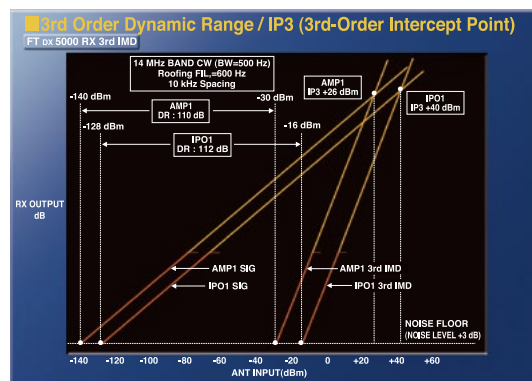



The completely new "4 selectable IPO positions" for various antennas and band conditions!

The 2SC4536 (NE46134) in the series RF amplifier design, produce a low distortion and low noise figure RF amplifier, which allows the receiver to perform at its best under the most diverse operating conditions. The new IPO System allows selection of four RF gain set-up conditions from the front panel. Choose IPO1 to feed a signal level to the mixer for the best possible IP performance. Choose IPO2 for no RF amplification.

The Double Quad Double Balanced Mixer system – Obtaining the best performance for your ultimate DX operation

Eight, 3SK294 Dual Gate MOS FETs are employed for the 1st mixer in a 2 x 4 configuration to establish the Double Quad Double Balanced Mixer. The Double Balanced Mixers using FETs have low losses by themselves so there is no need to obtain more gain than is required at the RF amp, resulting in the best desirable design for the RF Front End.

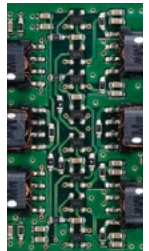

■ Mixer

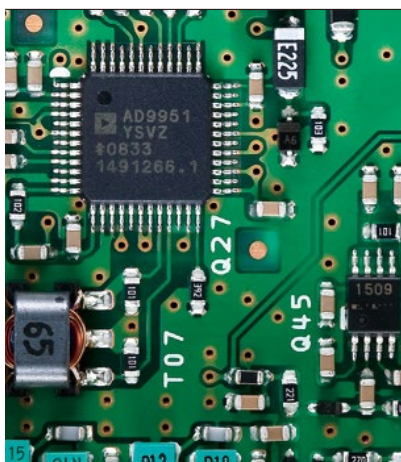

The uncompromised 400 MHz HRDDS system for the high quality local oscillator

In seeking to improve the strong-signal-handling capabilities of the receiver section, ultra-low-noise local oscillator system that produces a very clean 1st IF signal is essential. The high C/N ratio of the 400 MHz HRDDS (High Resolution Direct Digital Synthesizer) system that was implemented in the FT DX 9000 Series, has also been employed in the FT DX 5000 Series.

New-design Broad-range OCXO Reference Oscillator

The 10 MHz OCXO (Oven Controlled Crystal Oscillator), with industry leading frequency stability rated at ± 0.05 ppm over the temperature range of $+14^{\circ}\text{F}$ to $+140^{\circ}\text{F}$ (-10°C to $+60^{\circ}\text{C}$), Serves as the master reference oscillator for the FT DX 5000MP.

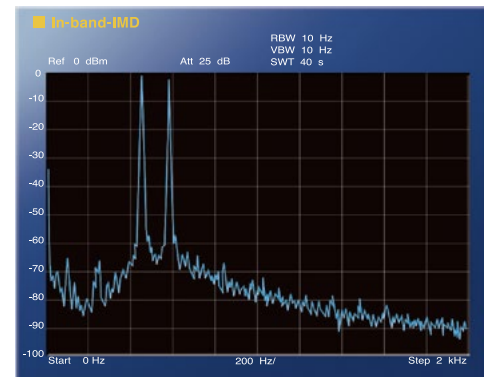

■ In-band-IMD
 RX=14.200MHz CW-USB IPO1 9MFL=300Hz
 DSPFIL=300Hz AGC=SLOW PITCH=500Hz

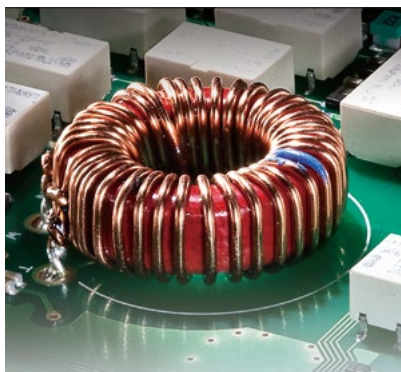

Variable RF Filter (VRF) – Covering the 1.8 - 28 MHz

To provide protection for the RF stages, as well as the two IF stages, the front end filtering system utilizes a combination of 15 fixed bandpass filters and Yaesu's exclusive VRF Preselector system. Those two RF filter systems protect the early stages of the receiver from overload caused by strong out-of-band signals. The high-Q VRF system is much narrower in bandwidth than the fixed bandpass filters, and it is crafted using high-permeability toroidal coils and tuning capacitors, producing 62 tuning steps for optimal rejection of broadcast or commercial service interference.

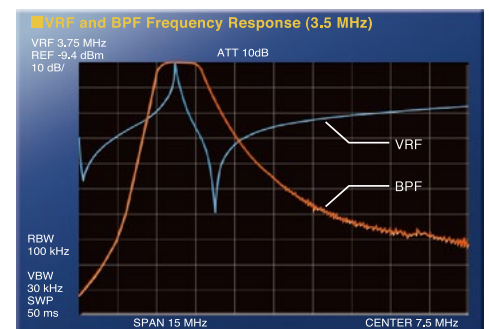

■ 10 dB/Div • 2 MHz/Div • SPAN 15 MHz (Blue VRF / Orange BPF)

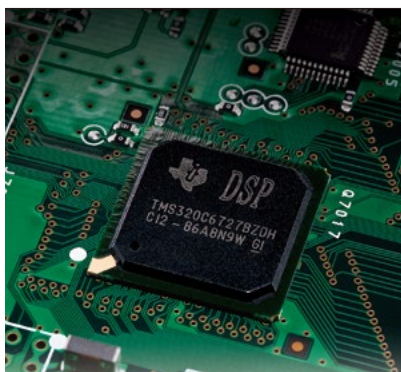

The 32-bit Floating Point IF Digital Signal Processing System

■ World-renowned Variable IF WIDTH / IF SHIFT Interference Reduction Systems

The IF Shift system allows the actual passband to be moved higher or lower in frequency, eliminating interference that is encountered outside the passband, while leaving the pitch of the incoming signal and the bandwidth of the IF passband unchanged. You can also improve reception by choosing to narrow the bandwidth of the IF WIDTH function and then varying the passband with the IF SHIFT.

■ Passband Response CONTOUR Control with an Analog Touch

The incredibly sharp "brick wall" filters of the IF DSP system can expose characteristics of incoming signals that you have never heard before, and not all of them are really pleasant to listen to. Using the CONTOUR control, you can roll off low-frequency or high-frequency components to shape the receiver passband differently, or null out part of the mid-range area, with continuous adjustment throughout the passband.

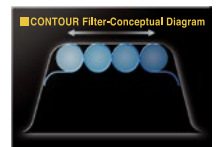



Ultra-Clean Transmitter Design

■ **High-power, Super-stable Final Amplifier Stage (200 W, Class-A Mode - 75 W)**

The FT DX 5000 MP utilize push-pull VRF150 MOS FET devices (VDSS=170 V, VGS= ± 40 V, PD=300 W), operating at 50 V, with user-adjustable bias control to ensure the optimum suppression of intermodulation distortion products.

■ **Ultimate Low Distortion Class-A Final Amplifier**

The FT DX 5000 includes provision for operation in a "Class-A" mode at 75 Watts output, utilizing high bias current to produce very low transmitter intermodulation products; the 5th and higher order IMD is typically suppressed 65 dB or better!

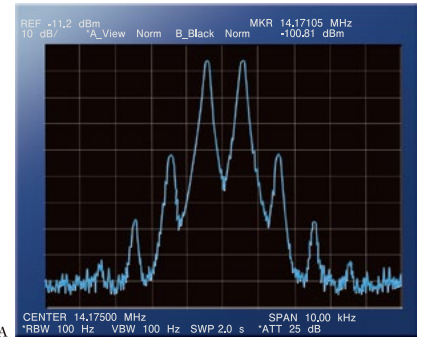

■ Class-A

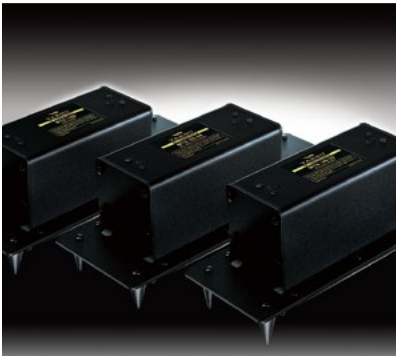

Optional Fully-automatic External μ-tuning with 1.1" (28 mm) Coil

On the lower Amateur Radio Bands, high signal voltages impinging on a receiver can create noise and intermodulation effects that may cover up weak signals you are trying to pull through. Now, three optional tuning modules (MTU-160, MTU-80/40, and MTU-30/20) are available to cover all the Amateur Radio bands from 160-meters to the 20-meter band!

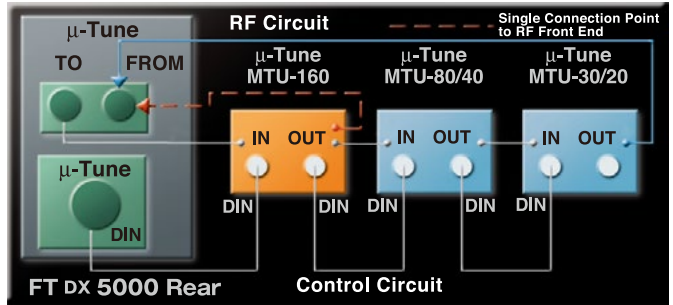

■ RF μ-Tune unit Connection Diagram



The Optional DMU-2000 External Data Management Unit will enhance your DX operation!

The same operating and station information, available with the FT DX 9000 Series, can be conveniently displayed by adding the optional DMU-2000 Data

Management Unit and an after-market PC display (Analog screen resolution: 800 x 600/SVGA, 1024 x 768/XGA standard).



■ Spectrum Scope Display



■ Audio Scope/Oscilloscope Display



■ World Clock Display

■ Swept-Frequency SWR Display

■ Memory Channel List

■ Rotator Control Function



QUADRA SYSTEM



- VL-1000 HF-50 MHz 1 kW Linear Amplifier*1 (50 MHz; 500 W/USA Version) Automatic Antenna Tuner Built In
- VP-1000 VL-1000 Power Supply*1



- SP-2000 External Speaker with Audio filters



- SM-5000 Station Monitor with stereo speaker system



- DMU-2000 Data Management Unit*2

- SCU-27 Antenna Rotator Connection Cable

RF μ-Tune Kits
Wt. abt. 5.7 Lbs(2.6 kg)/ 5 W x 4.7 H x 13 D in (127 x 120 x 328mm)



- RF μ-Tune Kits A For 160 m Band
- RF μ-Tune Kits B For 80/40 m Band
- RF μ-Tune Kits C For 30/20 m Band

● Up to three/3 μ-Tune Kits may be installed. All or any μ-Tune Kits shall be installed by the users.



- SCU-17 USB Interface Unit (Requires SCU-21)

- SCU-21 Connection Cable



- M-1 Reference Microphone



- M-100 Dual-Element Microphone



- MD-200A8X Ultra High Fidelity Desktop Microphone



- MD-100A8X Desktop Microphone



- YH-77STA Lightweight Stereo Headphone

*1 USA and Asian versions only *2 After-market PS/2 Keyboard and personal computer monitor are required for use of DMU-2000 and are not supplied.

Heritage continues FTDX3000

The FTDX3000D is the newest member of the YAESU FTDX Series. It inherits the design concepts of the FTDX9000 and FTDX5000 transceivers that have received high praise from all over the world by those pursuing the highest ideal of Amateur HF communication equipment.



Building on the YAESU FT DX Heritage



HF/50 MHz 100 W Transceiver

FTDX3000D 100 W

- ± 0.5 ppm TCXO included
- 300 Hz Crystal Roofing Filter optional
- 600 Hz Crystal Roofing Filter included
- 3 kHz Crystal Roofing Filter included

Supplied Accessories

-  ■ FH-2 Remote Control Keypad
Message Keyer, Audio Message Memory Command and Selection
-  ■ MH-31B8 Hand Mic
- T9025225 DC Cable

Optional Accessories

-  ■ M-1 Reference Microphone
 - Revolutionary dual microphone configuration
 - Nine-band graphic equalizer
 - Treble Boost Cowling produces a unique tonal texture
-  ■ SP-20 External Speaker
 - Audio Output: 7 watts
 - Impedance: 8 ohms
 - Size: W5.12" x H4.53" x D12.28" (130 x 115 x 312mm)

The RF front end boasts the ultimate receiving performance
This is the Heritage of the High Performance Receiver

© The powerful narrow bandwidth crystal roofing filter enhances the receiver multi-signal characteristics

The Down Conversion receiver construction is similar to the FT DX 5000. The first IF frequency is 9 MHz. This makes possible the narrow bandwidth crystal roofing filters (300 Hz, 600 Hz or 3 kHz) with a sharp shape factor, and creates the amazing multi-signal receiving performance. The 3 kHz roofing

filter greatly improves SSB signal reception, during close adjacent multi signal conditions. The 300 Hz and 600 Hz roofing filters provide the best CW receiving environment when the adjacent signals may affect the desired signal reception. *Note: 300 Hz filter optional.

© Phenomenal multi-signal characteristics that were demonstrated in the FT DX 5000

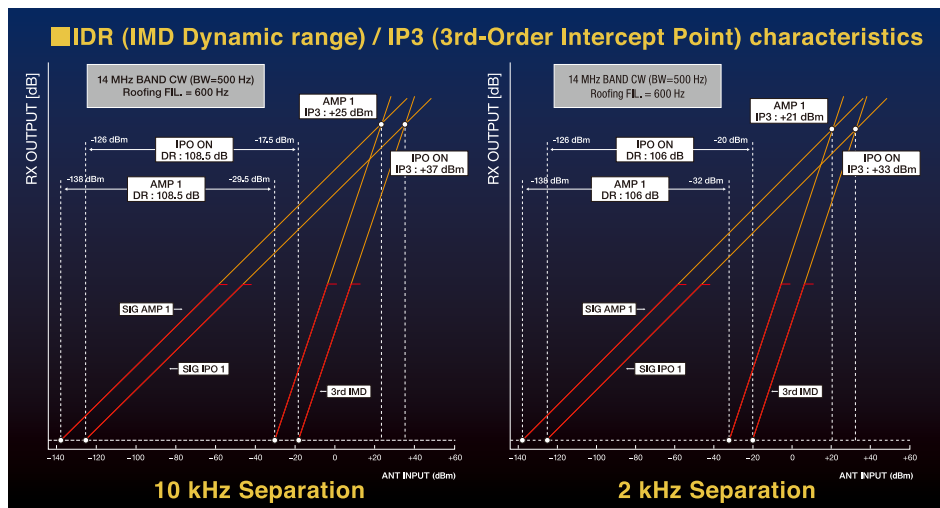

Using the two signal dynamic range measuring method with 10 kHz signal separation, the FT DX 3000 performance is 108.5 dB, IP3 +37 dBm. With frequency separation of only 2 kHz between the desired signal and an interfering signal, the dynamic range measures 106 dB and IP3 +33 dBm. This is amazing!



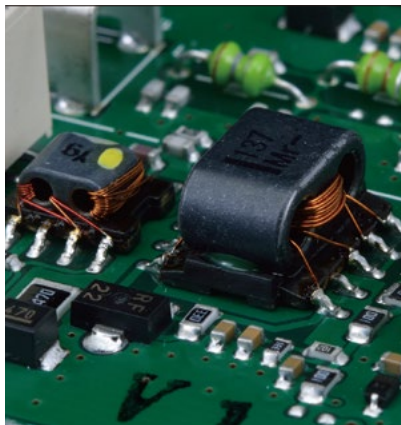

This is the tradition of the YAESU FTDX series. The RF front end realizes the ultimate receiver performance for HF radios.

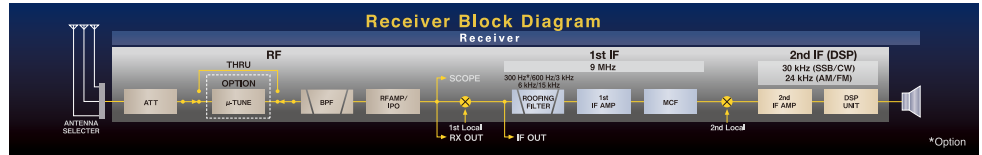

The RF front end circuit is the most important element, and determines the HF receiver performance. Our Yaesu Engineering team has concentrated superior RF engineering knowledge into the design of the FT DX 3000 front end. Fifteen separate band pass filters (BPF) are used for the front end protection, this effectively reduces the undesired and out of band signals. In the RF

amplifier, the strong bipolar transistor (2SC3357) is used. This transistor shows a low NF, and realizes superior intermodulation performance. The gain of each individual device is kept lower, and the best optimized working point, with the lowest NF, is selected. In addition, a custom-designed wide band transformer, with less magnetic saturation, is used for the I/O of the RF amplifier.

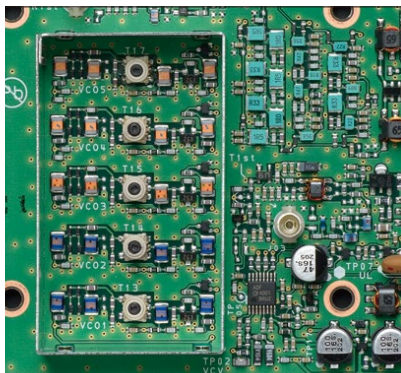

High Quality, High Stability Local Oscillator

High accuracy TCXO and the DDS & PLL circuits realize unmatched Local Oscillator signal quality

The S/N ratio (signal-to-noise ratio) of the local signal that is injected into the 1st IF mixer, is one of the most important factors for improving the receiver properties in the crowded multi-signal environment. In the FT DX 3000, the combination of the highly stable and highly accurate 40 MHz TCXO ($\pm 0.5\text{ppm}$, $-10^\circ\text{C} \sim +60^\circ\text{C}$), and the DDS, create the fundamental frequency of this radio, and is locked to the PLL-IC and VCO directly. This circuit construction and method

creates the highest quality local signal, with superior S/N performance. This means the receiver noise floor is kept lower, and realizes the best blocking

dynamic range at 2 kHz IP3 performance. This is a phenomenal improvement!

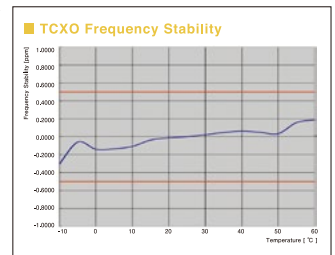

Effective QRM rejection with the FT DX 3000 IF DSP

The 32-bit high speed floating decimal point DSP, TMS320C6727B (maximum 2800 MIPS/2100 MFLOPS) made by Texas Instruments, is

used for the IF section of the FT DX 3000. The signal is processed with the high speed 300 MHz clock frequency.

Well proven IF WIDTH and IF SHIFT functions provide great QRM rejection performance

You can adjust the IF WIDTH and IF SHIFT, and eliminate the QRM, by rotating the SHIFT/WIDTH knob located on the front panel.

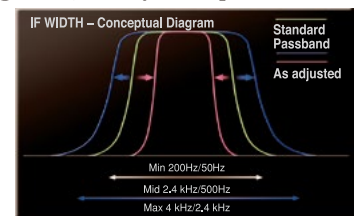
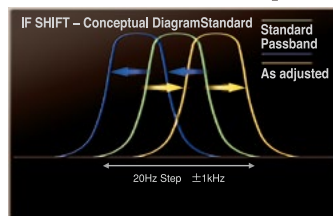

Stabilized High RF Output and High Quality Transmission Signal

The Final Amplifier provides stabilized high RF output

For the RF final amplifier, RD100HHF1 MOS FETs are used in the push-pull amplifier construction. This circuitry provides stabilized RF power performance. The amplifier produces a clean transmit signal with less spurious emissions and distortion. The large heat sink is combined with the die cast chassis and has 1200 cc capacity.

High Speed Automatic Antenna Tuner includes 100 Memory Channels

The FT DX 3000 antenna tuner is the digital type that uses LC switching. It has a large capacity memory, and the tuning data is automatically memorized in the 100 channel memory. The optimized antenna tuning data is immediately recalled to reduce tuning time when changing frequency, and the best matching point is realized.

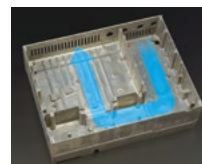



Superior Operability and Visibility

■ **A huge TFT full-color display**

The FT DX 3000 presents a wide, 4.3-in TFT full color display, which provides a convenient view of the radio's working functions. Even though the FT DX 3000 has many features and functions, the TFT display makes operation of the radio easy and comfortable for both new and experienced users.

■ **The Block Diagram displays the RX Signal Path**

The TFT color display also provides a block diagram of the radio circuitry showing the RX signal path and the RX settings. The receiver configuration and signal path can be observed

with a brief glance at the screen.

■ **Separate Independent Frequency Display**

The operating frequency is additionally shown in a large wide display, directly above the main VFO dial knob, and is separate from the main information display of the radio. This is one of the most important features of the FT DX 3000 transceiver. Superior operability is realized with this convenient display. A wide view angle, high contrast LCD (negative type VA-LCD), is used for the display. It permits excellent visibility from wide viewpoints.

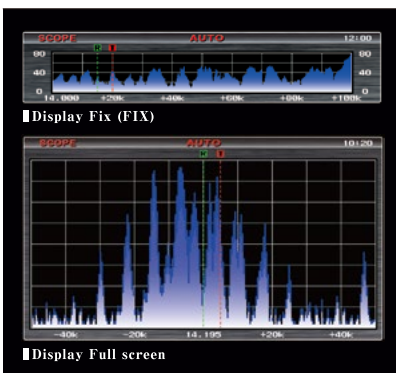

High Speed Spectrum Scope function included

The FT DX 3000 has a high speed, high resolution Spectrum Scope included as standard, making it possible to visualize signals, and tune to their frequency in the band. Changes of the signals that vary moment by moment across the band can be viewed immediately. The Bandwidth of the spectrum scope may be set to any of six different spans: 20kHz, 50kHz, 100kHz, 200kHz, 500kHz, or 1MHz. In the case of split operation, TX and RX markers will appear in the spectrum scope, making the relationship between transmit frequency and receive frequency easily observed.

AF-FFT Scope Function demonstrates the AF characteristics of the TX/RX signal

The FT DX 3000 also has an AF-FFT (Audio Frequency Fast Fourier Transform) scope built in. With this Scope, the audio characteristics of the received signals; the effect of adjusting the RX IF filter performance; and the affects of utilizing the QRM rejection features, may be visually observed.

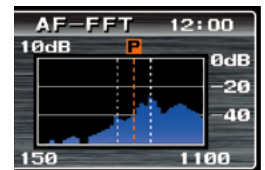

■ AF-FFT scope (normal display)



CW decode feature

The FT DX 3000 has a Morse code, decode function that can decipher and show the characters on the TFT screen. This function helps the CW beginner and supports the actual CW communications by showing the decoded message on the display.

RTTY/PSK31 Encode Decode function

The FT DX 3000 has a practical RTTY and PSK31 encoder and decoder. On the AF-FFT screen, the programmed mark and space frequencies are displayed, making it possible to easily tune to the peak of the received signal..

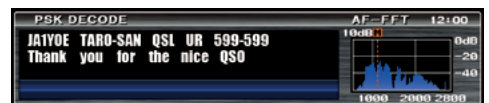
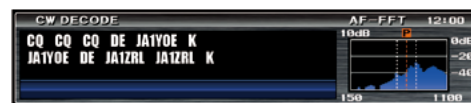

QUADRA SYSTEM



- VL-1000 HF-50 MHz 1 kW Linear Amplifier* (50 MHz: 500 W/USA Version) Automatic Antenna Tuner Built In
- VP-1000 VL-1000 Power Supply*

- XF-127CN CW Narrow Crystal Filter (C/F: 9 MHz; B/W 300 HZ)
- DVS-6 Voice Memory Unit
- FC-40 Automatic Antenna Tuner (for Long wire antenna)

- CT-178 VL-1000 Connection Cable* | ● CT-39A Packet Interface Cable
- SCU-27 Antenna Rotator Connection Cable

RF μ-Tune Kits
Wt. abt. 5.7 Lbs (2.6 kg) / 5 W x 4.7 H x 13 D in (127 x 120 x 328mm)

- RF μ-Tune Kits A For 160 m Band
- RF μ-Tune Kits B For 80/40 m Band
- RF μ-Tune Kits C For 30/20 m Band



- FP-1030A External Power Supply* (13.8 VDC 25 A)



- FP-1023A (USA Only) External Power Supply (13.8 VDC 23 A)



- SP-20 External Speaker

● Up to three 3/3 μ-Tune Kits may be installed. All and any μ-Tune Kits shall be installed by the users.



- M-1 Reference Microphone



- M-100 Dual-Element Microphone



- MD-200A8X Ultra High fidelity Desktop Microphone



- MD-100A8X Desktop Microphone



- YH-77ST A Lightweight Stereo Headphone

*USA and Asian versions only

Reliable and Exciting, Superior Transceiver - the Real Deal
Indisputably, Best in Class Performance and Supreme Operability

FTDX1200

This medium-price HF Transceiver Excels on all fronts. The High Frequency Design Technology it has inherited, ensures "Best-in Class Performance". The Outstanding Operability is Perfect for the DX Scene.



A highly balanced receiver circuit inheriting the design concepts of the Yaesu FT DX series



HF / 50 MHz 100 W Transceiver

FTDX 1200 (100 W)

±0.5 ppm TCXO included
3 kHz, 6 kHz, and 15 kHz Roofing Filters included

Supplied Accessories

- MH-31B8 Hand Microphone



- T9025225 DC Cable

Optional Accessories



- M-1 Reference Microphone
 - Revolutionary dual microphone configuration
 - Nine-band graphic equalizer
 - Treble Boost Cowling produces a unique tonal texture



- SP-20 External Speaker
 - Audio Output: 7 watts
 - Impedance: 8 ohms
 - Size: W5.12" x H4.53" x D12.28" (130 x 115 x 312mm)

The 3 kHz Roofing Filter is very effective in attenuating interfering signals

Roofing filters of 3 kHz, 6 kHz and 15 kHz, are fitted ahead of the 40.455 MHz 1st IF. Sharp four element MCFs that filter by means of the fundamental oscillation mode, with excellent distortion characteristics, are utilized. By incorporating a 3 kHz narrow band roofing filter, (which is difficult to realize in the higher frequencies) before the 1st IF stage, strong out of band interfering signals have been significantly attenuated. This, reduces the later burden on the mixer, and improves the adjacent multi signal characteristics.

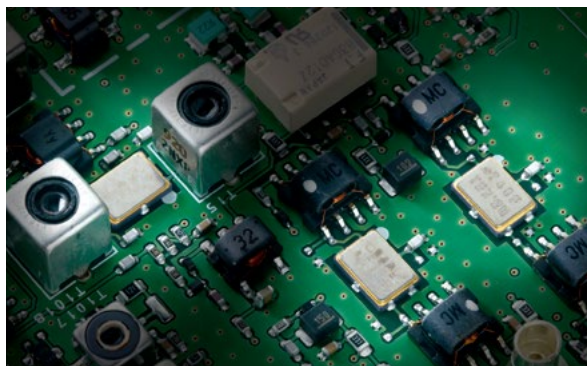

■ 3kHz,6kHz,15kHz Roofing Filter

IDR (IMD Dynamic range) / IP3 (3rd-Order Intercept Point) characteristics

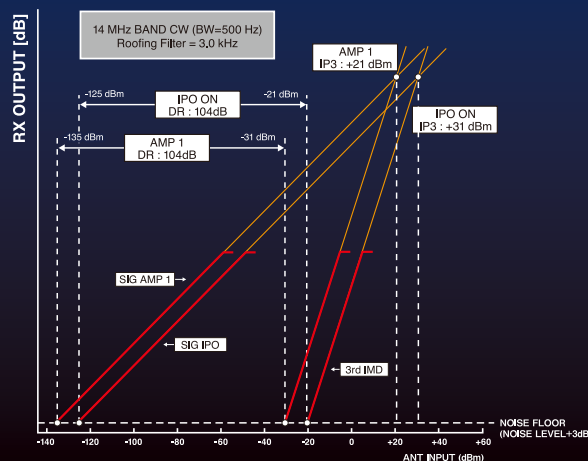

10 kHz Separation

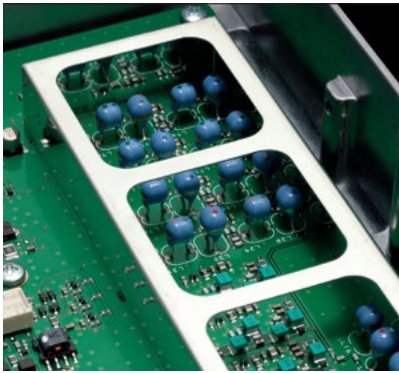

Triple conversion circuit configuration implements optimized gain distribution

The triple conversion circuit structure allows highly flexible gain distribution at each stage. This enables elimination of unwanted signals through filters at each stage as well as optimized gain distribution. By following the FT DX series design

concepts and through careful research in repeated field tests, the FT DX 1200 delivers a state of the art highly balanced receiver circuit configuration.

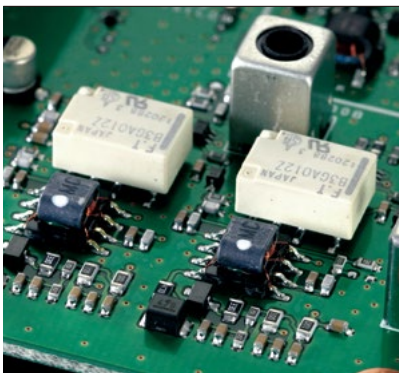
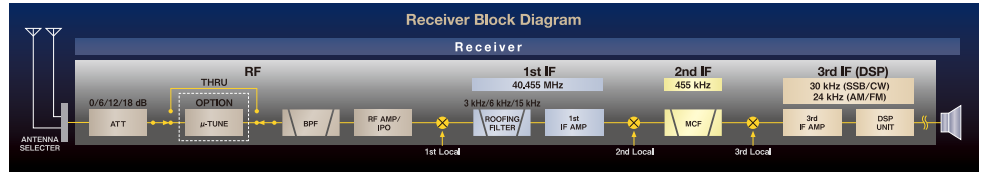

IPO function allows selection of the optimum RF amplifier circuit configuration for each noise and signal circumstance

The RF amplifier uses two proven negative feedback type 2SC3356 bipolar transistors. We thoroughly tested the surrounding circuit constants, which determine the circuit characteristics, and also the board layout to achieve optimum results. As the two transistors are connected in series, the working point with the optimum NF can be selected without focusing on the gain. Excellent multi signal characteristics, with a low NF are achieved. The optimum working point of the RF amplifier circuit is not always fixed; it may be configured according to the receiving band, the connected

antenna, the signal and the noise conditions. The IPO (Intercept Point Optimization) can be switched using the IPO switch on the front panel. The RF amplifier operation can be changed with the IPO to send the optimum signal levels to the mixer.

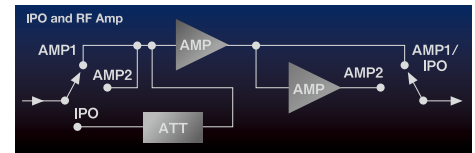

The acclaimed IF DSP is powerful, versatile and effective in actual operation

■ **The beneficial effect of the YAESU IF DSP**
Using the 32-bit high speed floating point DSP, TMS320C6727B by Texas Instruments, similar to the high end FT DX 5000 and FT DX 3000 series. The processor runs at a clock speed of 300 MHz. The high speed digital processing power of the 30 kHz 3rd IF signal provides high QRM rejection performance for the actual signal through the acclaimed superior YAESU algorithm.

■ **Digital Noise Reduction (DNR)**

The noise reduction constants may be set to the

optimal working point by varying the 15 step parameters according to the actual noise within the HF band. The desired signal components are peaked and the random noise components are effectively cancelled.

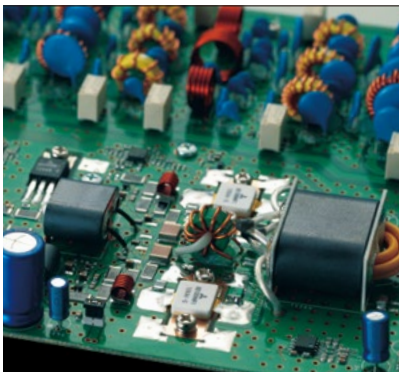
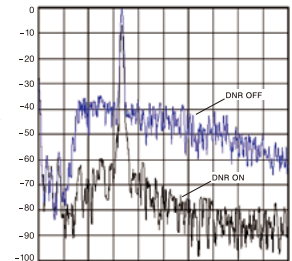

Final amplifier supplies high quality stable high output

■ **Highly reliable high output final amplifier**
The final amplifier, which has two RD100HHF1 MOS FETs and amplifies in a push-pull configuration, with high power levels of 100 W, can transmit superb high quality emissions with little distortion and fewer spurious and other unwanted signals. A structure is used that combined with the die cast chassis dissipates the generated heat in the final amplifier section, providing ample capacity as a 1200 cc heat sink. The aluminum used for the die cast has high thermal conductivity and lowers the heat resistance.

■ **High Speed Automatic Antenna Tuner includes 100 Memory Channels**

The FT DX 1200 antenna tuner is the digital type that uses LC switching. It has a large capacity memory, and the tuning data is automatically memorized in the 100 channel memory.

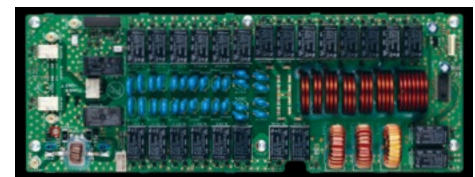



True feel of superior intuitive operability and an attractive appearance

■ Huge TFT full-color display

The superior panel layout is characteristic of YAESU transceivers. The efficient display has been designed with more than just appearance in mind. This transceiver has a natural operability that, despite its wide variety of functions, allows for an immediate sense of familiarity with its operation and display. The display layout has also been meticulously considered. The most important meters during communication and frequency examination, are displayed in central view, with the various

transmission and receiving function displays arranged around them. Everything is in direct view and the effects of an operation can be visually confirmed straightaway, thus allowing stress-free full concentration when operating over long periods of time.

■ Graphic display enabling intuitive QRM rejection

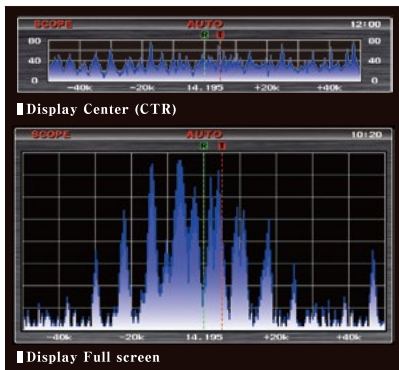

ASC (Automatic Spectrum-Scope Control)

A spectrum scope function that allows for an instant view of the signals, their strengths and distribution within a band is supplied as standard. The spectrum scope sweep function has two modes available: the manual mode, where the band is swept once when the SELECT button is pressed, and the ASC mode where the band is automatically swept at preset intervals. No receive audio is generated during sweeping, but as sweeping is done at an extremely high speed this is a brief instant of approximately 300 msec. If the operator quickly

operates the main dial to make a big frequency change in ASC mode, an automatic sweep is performed and the display is refreshed. This enables frequency tuning while checking the spectrum in real time. The moment tuning is halted the receive frequency audio is resumed. The Band Scope can be switched to a full-screen display by simply pressing the SCOPE key, and the signal spectrum can be viewed in detail on the Full TFT screen.



Optional unit FFT-1 (FFT Unit)

■ AF-FFT Scope Function demonstrates the AF characteristics of the TX/RX signal
With the optional FFT-1, the FT DX 1200 has an AF-FFT (Audio Frequency Fast Fourier Transform) scope.

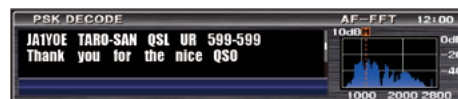
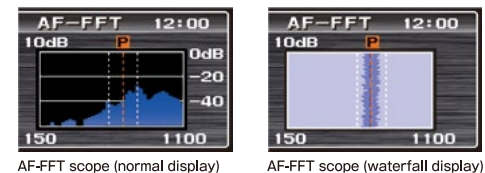

■ CW decode feature

The FT DX 1200 has a Morse code, decode function (requires optional FFT-1) that can decipher and show the CW characters on the TFT screen.

■ CW Auto Zero-in

The received CW signal frequency may be detected (requires optional FFT-1) and the VFO automatically tuned to match the frequency and programmed pitch (auto-zero-in).

■ RTTY/PSK31 Encode Decode function

QUADRA SYSTEM

● VL-1000 HF-50 MHz 1 kW Linear Amplifier* (50 MHz: 500 W/USA Version) Automatic Antenna Tuner Built In

● VP-1000 VL-1000 Power Supply*

RF μ -Tune Kits
Wt. abt. 5.7 Lbs (2.6 kg) / 5 W x 4.7 H x 13 D in (127 x 120 x 328mm)

- RF μ -Tune Kits A For 160 m Band
- RF μ -Tune Kits B For 80/40 m Band
- RF μ -Tune Kits C For 30/20 m Band

● FP-1030A External Power Supply* (13.8 VDC 25 A)

● FP-1023A (USA Only) External Power Supply (13.8 VDC 23 A)

● SP-20 External Speaker

● FFT-1 FFT Unit

● DVS-6 Voice Memory Unit

● FH-2 Remote Control Keypad

● SCU-17 USB Interface Unit

● M-1 Reference Microphone

● M-100 Dual-Element Microphone

● MD-200A8X Ultra High fidelity Desktop Microphone

● MD-100A8X Desktop Microphone

● YH-77STA Lightweight Stereo Headphone

● FC-40 Automatic Antenna Tuner (for Long wire antenna)

● CT-118 VL-1000 Linear Amplifier Connection Cable*

● CT-39A Packet Interface Cable

● SCU-27 Antenna Rotator Connection Cable

● SCU-28 Linear Amplifier Connection Cable

*USA and Asian versions only

High Reliability and Durability are Assured for Long-lasting Enjoyable Operations on the HF Bands **FT-891**

HF/50MHz 100W All Mode Exciting Field Gear Transceiver
 In keeping with Yaesu's uncompromising receiver design,
 The 3kHz Roofing Filter is included as standard equipment



HF/50 MHz 100 W All Mode Mobile Transceiver

FT-891

Supplied Accessories: MH-31A8J Hand Microphone, Mobile Mounting Bracket, DC Cable

Rugged construction in an Ultra Compact body

ULTRA COMPACT Design

Measuring 6.1" x 2.0" x 8.6" (155 x 52 x 218 mm), the FT-891 is an innovative Multi-band, Multi-mode Mobile/Portable transceiver with Ultra Compact and rugged case design.

100 Watts Reliable High Power Output

The FT-891 provides stable 100W high power output. High reliability is assured by the careful transmitter circuit design with efficient thermostatically-controlled Dual internal fans and the diecast chassis.



Thermostatically-controlled Dual Internal fans

Yaesu Uncompromising Receiver Circuit Design Ensures Excellent Performance

- Triple conversion with 1st IF frequency of 69.450 MHz (SSB/CW/AM)
- 3 kHz roofing filter equipped as standard
- TCXO provides ±0.5 ppm High frequency stability (-10°C to +50°C)

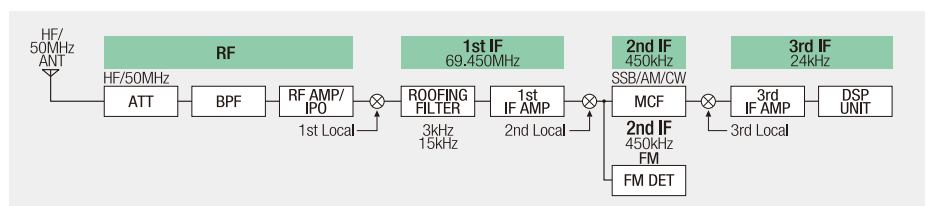



32-bit High Speed Floating Point DSP

IF DSP Provides Effective and Optimized QRM Rejection

The 32-bit high speed floating Point DSP (max 3000 MIPS) provides effective cancellation/reduction (DNR) of the random noise that is frequently frustrating in the HF frequencies. Also: the AUTO NOTCH (DNF) automatically eliminates the dominant beat tone. The CONTOUR and the APF are very effective receiver noise reduction tools in the HF bands operations. The YAESU original DSP QRM and noise reduction functions are provided.

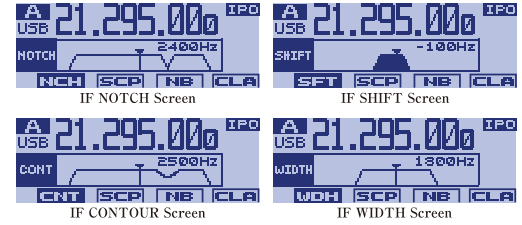

The Large Diameter Main Tuning Dial

Large Diameter Main Tuning Dial (1.6"/41mm) with Torque Adjustment

The FT-891 operation is enhanced by the large diameter (1.6"/41mm) Main Tuning Dial, which is similar in size to the tuning knob of the larger-sized HF base station. The Torque of the Main Tuning Dial can be adjusted easily for your operating preferences.

Front Panel Design Achieves Optimal Operability

- Three Programmable Front Panel Function Keys may be set to the user's personal preferences
- Multi-Function knob allows quickly changing the operating band, and adjusting other settings.
- Large Transmit/Receive indicator LEDs clearly inform the operator about the current state of the transceiver



Detachable Front Panel for Convenient Mounting and Operation

Convenient mobile operation by remotely mounting the Control Panel with the optional front panel separation kit (YSK-891)

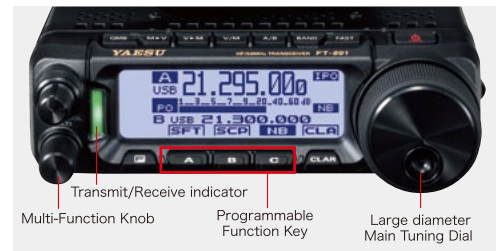

Useful and Convenient Functions

- Large dot matrix LCD display with Quick Spectrum Scope
- USB port allows connection to a PC with a single cable (CAT control, PTT/RTTY control)
- TUN/LIN connector allows connection of optional FC-50 or VL-1000
- Advanced electronic keying (4 to 60 WPM) with FULL BK-IN support
- Supports Active-Tuning Antenna system (ATAS-120A, ATAS-25 :Option)

QMB (Quick Memory Bank) Function

The QMB key accesses the five "Quick Memory Bank" registers, to organize and store groups of frequencies, and easily recall them.

Automatic-Matching 100 Memory Antenna Tuner (Optional)

The FC-50 is an optional microprocessor-controlled antenna tuner that is designed specifically for use with the FT-891. The FC-50 can be easily attached to the FT-891.

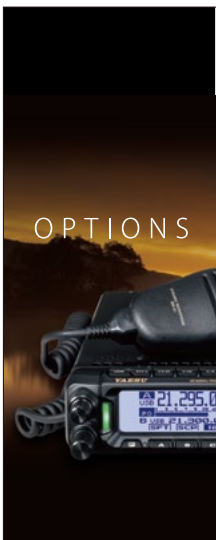

QUADRA SYSTEM



● VL-1000 HF-50 MHz 1 kW Linear Amplifier*1 *2 *3 (60 MHz: 500 W/USA Version) Automatic Antenna Tuner Built In

● VP-1000 Power Supply*1 *2 *3



● MH-31 A8J Hand Microphone



● MH-36 E8J DTMF Hand Microphone



● M-1 Reference Microphone



● M-100 Dual-Element Microphone



● MD-200 A8X Ultra High Fidelity Desktop Microphone



● MD-100 A8X Desktop Microphone



● YH-77STA Lightweight Stereo Headphone



● FC-40 Automatic Antenna Tuner*3 (for Long wire antenna)



● YSK-891 Front Panel Separation Kit



● FH-2 Remote Control Keypad*2



● ATBK-100 Antenna Base Kit*3 (for Base operation on 6 m Band)



● CT-39A Packet Interface Cable



● CT-58 Band Data Cable for VL-1000*1 *2 *3



● ATAS-120A Active-Tuning Antenna*3 (Automatic Type)



● ATAS-25 Active-Tuning Antenna (Manual Type)

*1 USA and Asian versions only *2 VL-1000 and FH-2 cannot be used simultaneously. *3 VL-1000, FC-40, and ATAS-120A cannot be used simultaneously.

Compact HF/50 MHz ALL Mode Transceiver with IF DSP FT-450D

Proven performance and technology with YAESU state-of-the-art IF DSP

The ultimate compact HF/50 MHz transceiver
YAESU FT-450D



HF/50 MHz 100 W Transceiver

FT-450D

Supplied Accessories: MH-31A8J Hand Microphone, T9023725*/T9025225(CE) DC Cable

HF/50 MHz 100 W All Mode Transceiver FT-450D with Built-in Automatic Antenna Tuner

© The Real DX Receiver! The 67.899 MHz 4 pole roofing filter (MCF) and 8 band-pass filters at the RF stages, provide excellent suppression of out-of-band interference.

The interference-filtering begins in the "RF" stages, with a double conversion superheterodyne system. The 8 band-pass filters at the RF input help eliminate out-of-band interference, followed by the RF AMP (2SK520 x 2) that feed into the active DBM (1st local) assure excellent dynamic

range. At the 1st IF stage, a powerful 4 pole roofing filter with a 10 kHz bandwidth and excellent shape factor, substantially reduces adjacent signal interference.

© Operate anywhere using optional internal or external antenna tuning systems!

The FT-450D's Automatic Antenna Tuner includes 100 memories for quick tuning during field operation when using a folded dipole, etc. In addition, the YAESU original and unique Antenna Tuning systems, such as the External Automatic Antenna Tuner FC-40 or Active Tuning Antenna System ATAS-120A for mobiles, are ready to be automatically operated with the FT-450D front panel controls.

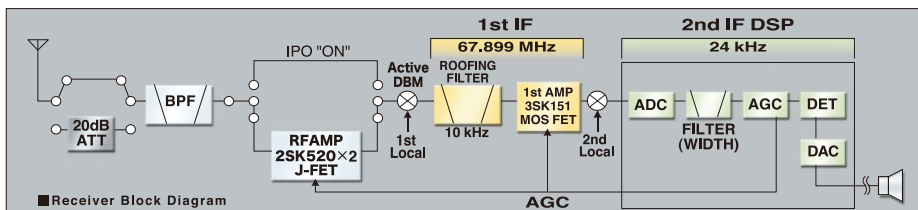

World-Class Performance in an easy-to-operate HF/50 MHz transceiver package with Yaesu's unique IF DSP.

The legendary YAESU IF DSP system, well regarded among top and world-class DX operators, is now available in an easy to operate package. The new IF DSP system uses an ADSP-BF 531SBST IC, with high speed 16/32-bit, fixed point architecture. Designed and programmed with the unique objective of "Enhanced Transmit Signal Quality" and "Advanced Receiving Interference Suppression".

IF SHIFT

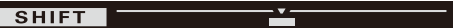

Vary the IF SHIFT higher or lower for effective interference elimination.

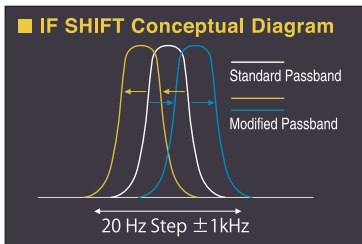

CONTOUR Control Operation



The Yaesu unique CONTOUR filter provides a gentle shaping of the passband. Specific frequency components may be suppressed or enhanced, to improve the sound and readability of the received signal with the DSP system.

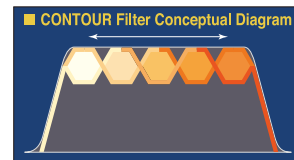

MANUAL NOTCH



Highly effective system that can remove an interfering beat tone or signal.

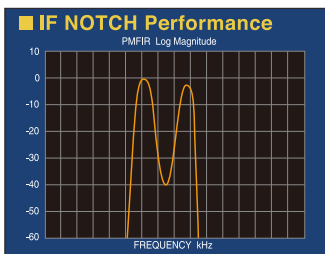

Digital Noise Reduction (DNR)



The DNR system analyzes the profile of the noise found on the HF and 50 MHz bands. Random noise is reduced and the sound and readability of the object signal is enhanced.

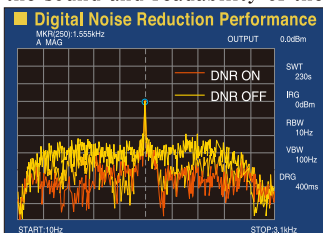

IF WIDTH



DSP IF WIDTH Tuning provides selectable IF passband widths to fight QRM. (SSB1.8kHz/CW 0.3 KHz) (CW-300 Hz/500 Hz/2.4 KHz)

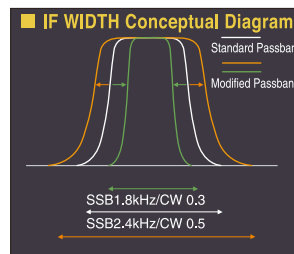

The Rugged aluminum die-cast chassis with large cooling fan is made for your heavy-duty, extended high power operation.

The newly designed push-pull power MOSFET (RDF 100HHF1) amplifiers guarantee powerful and reliable 100 W output operation. The FT-450D's rugged 490 cc aluminum die-cast chassis, with a large 2.8" x 2.8" (70 x 70mm) quiet thermostatically controlled cooling fan, is a solid foundation of the power amplifier during long hours of field use or home contesting operation.

Large informative Front Panel Display with convenient Control knobs and Switches

Even though it is a convenient compact size (9"x3.3"x8.5"/229 x 84 x 217mm), the FT-450D has a large and bright display, almost 25 % of the front panel. The original LCD negative type display shows the Frequency, S-meter, a Graphical indication of RF to IF settings, and the DSP Interference Elimination settings (Contour, Notch, DNR, Width and Shift).

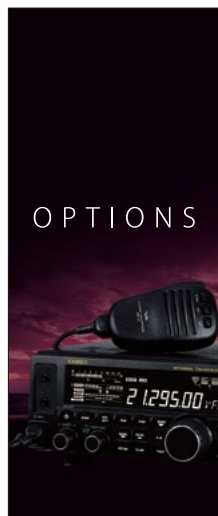
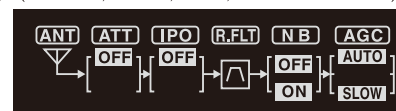

QUADRA SYSTEM



- VL-1000 HF-50 MHz 1 kW Linear Amplifier* (50 MHz: 500 W/USA Version) Automatic Antenna Tuner Built In
- VP-1000 Power Supply*
- CT-118 VL-1000 Connection Cable*



- MH-36E8J DTMF Hand Microphone



- MH-31A8J Hand Microphone



- M-1 Reference Microphone



- M-100 Dual-Element Microphone



- MD-200A8X Ultra High Fidelity Desktop Microphone



- MD-100A8X Desktop Microphone



- SCU-17 USB Interface Unit



- FP-1030A External Power Supply* (13.8 VDC 25 A)



- FC-40 Automatic Antenna Tuner (for Long wire antenna)



- MHG-1 Side Carry Handle



- MMB-90 Mobile Bracket



- YH-77STA Lightweight Stereo Headphone



- CT-39A Packet Interface Cable



- ATBK-100 Antenna Base Kit (for Base operation on 6 m Band)



- ATAS-120A Active Tuning Antenna System

*USA and Asian versions only

Wide-Coverage Transceiver with Real-Time Spectrum Scope and Multi-Color Waterfall

FT-991A

A Superb All-Around Amateur Radio Transceiver with a built-in real-time spectrum scope and superior basic operating performance covering the HF/50/144/430 MHz bands



HF/50/144/430 MHz 100 W All Mode Transceiver

FT-991A

(144 MHz 50 W/430 MHz 50 W)

Supplied Accessories: MH-31A8J Hand Microphone, T9025225 DC Cable

Optional Accessories

- SP-10
External Speaker
- Audio Output: 3 watts
- Impedance: 8 ohms
- Size (WHD): 4.33"x3.15"x9.96" (110x80x253mm)



SP-10

*Microphone M-1 / External Speaker SP-10 : Optional Accessories

Supports Real-Time Spectrum Scope with Multi-Color Waterfall Display

Ⓞ Instantly evaluate band conditions with the built-in real-time spectrum scope

Listen to the received audio while tuning with the built-in high resolution real-time spectrum scope. Instantly evaluate ever-changing band conditions and easily find the desired signals. TX and RX markers are displayed on the scope for immediate grasp of the relationship between the TX and RX frequencies. The display color of the scope screen can be selected as preferred.



Ⓞ Supports multi-color waterfall display

The waterfall display function presents the strength of the RX signals using color variations flowing with time. This allows for visual recognition of even the faint signals which rarely appear as peaks, offering a more detailed view of the band. The color of the waterfall screen can be selected from seven colors, or the multicolor array.



Ⓞ Latest Touch Panel Operation, combined with traditional Front panel layout, achieves optimal operating convenience

- Full color TFT LCD display provides useful information about function status and settings at a glance
- Highly responsive panel, with functional design and intuitive layout, makes touch operation a pleasure
- Four user-customizable function keys offer quick access to mode-dependent assignments
- Traditional layout of the Main Dial knob and related controls makes experienced users feel right at home



Uncompromising Receiver Circuit Design Ensures Excellent Basic Performance from HF to VHF/UHF

© Sophisticated receiver front end performance on a par with FTDX Series Transceivers

■ **Triple conversion with a 1st IF frequency of 69.450MHz for all bands**

■ **1st IF stage implements a narrow bandwidth 3 kHz roofing filter as standard equipment**

Designed for outstanding adjacent multi signal characteristics, in the HF, VHF and UHF bands.



■ 3 kHz and 15 kHz Roofing Filters

■ **The 1st IF mixer for HF/50 MHz features a quad mixer that assures extremely low noise, excellent intermodulation characteristics, and high dynamic range.**

■ **A dedicated VHF/UHF mixer, is separate from the HF bands, and permits design optimization for targeted frequencies.**

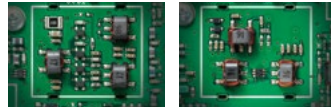

■ HF/50MHz Quad Mixer ■ VHF/UHF Mixer

© RF amplifier design is optimized for each band

■ **Selectable IPO/AMPI/AMP2 settings for HF and 50MHz, optimize the receiver RF amplification**

■ **Separate RF amplifiers provide the best characteristics for each band and signal conditions**

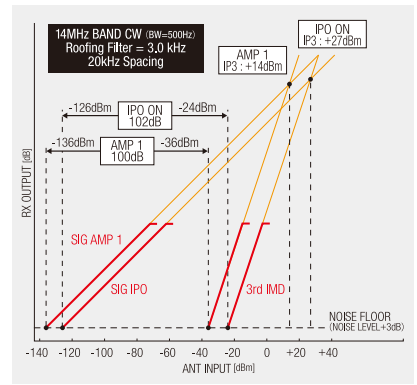

■ IDR (IMD Dynamic range) / IP3 (3rd-Order Intercept Point) characteristics

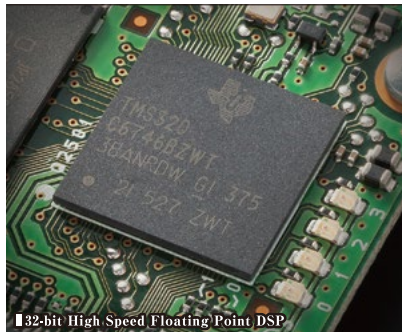

■ 32-bit High Speed Floating Point DSP

IF DSP from YAESU is Famous for Superb Interference Rejection

■ **Same high-speed floating point DSP as used in FTDX Series**

The high speed floating point DSP chip TMS320C6746 (3000 MIPS / 2250 MFLOPS) makes possible excellent interference rejection with actual signals under real-world conditions.

■ **Highly effective interference rejection**

The IF WIDTH and IF SHIFT functions form the basis to effectively remove interfering signals. The DNF (AUTO NOTCH) filter rapidly tracks and removes even multiple heterodyne signals.

The CONTOUR function can emphasize the desired audio components for the most distinguishable communications sound. The selectable bandwidth NOTCH is combined with the other noise reducing functions to provide convenient DX and Contest QSO operation.

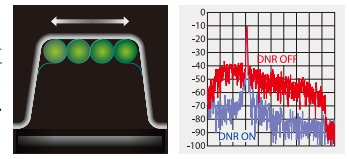

■ CONTOUR Filter Conceptual Diagram ■ Digital Noise Reduction Performance

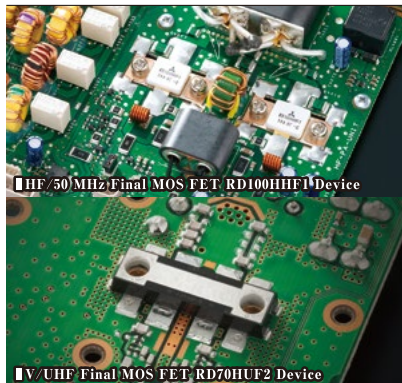

■ HF/50MHz Final MOS FET RD100HHF1 Device

■ V/UHF Final MOS FET RD70HUF2 Device

Final Stages Provide Ample Power Reserves: 100 W for HF/50 MHz Band and 50 W for VHF/UHF Band

■ **High quality push-pull amplifier with 100 watts for HF and 50 MHz**

Using a push-pull arrangement of RD100HHF1 MOS-FET devices that are renowned for excellent performance in the HF and 50 MHz frequencies.

■ **High speed 1.8 to 54 MHz antenna tuner included as standard equipment**

■ **50 W amplifier for VHF/UHF assures plenty of power for high frequency bands**

The final amplifier for the VHF and UHF bands uses the high-output MOS-FET RD70HUF2 device, providing ample output power of 50 watts.

Support for Advanced C4FM Digital Functions

- V/D mode for simultaneous transmission of voice and data with powerful error correction is optimal for mobile use, and for Voice FR (Full Rate) mode high quality audio transmission
- AMS function instantly recognizes digital mode or FM mode, and enables automatic communication with stations using either mode.
- GM (Group Monitor) function allows handy on-screen display of group members that are within communication range
- 126 types of DSQ (Digital Squelch) enable specific selection of communicating stations
- Supports high-definition Amateur Radio WIRES-X internet connection, utilizing C4FM digital technology

*Does not support operation of WIRES-X digital node stations.
*Does not support sending and receiving of images via C4FM digital.

QUADRA SYSTEM

VL-1000
HF-50 MHz 1 kW Linear Amplifier*1 #2 #3
(50 MHz: 500 W/USA Version)
Automatic Antenna Tuner Built In

VP-1000
Power Supply*1 #2 #3

CT-58
Band Data Cable for VL-1000*1 #2 #3

FH-2
Remote Control Keypad*2

FP-1023A (USA Only)
External Power Supply (13.8 VDC 23 A)

FP-1030A
External Power Supply*1
(13.8 VDC 25 A)

FC-40
Automatic Antenna Tuner*3
(for Long wire antenna)

<p>M-1 Reference Microphone</p> <p>MH-36 E8J DTMF Hand Microphone</p> <p>SP-10 External Speaker</p>	<p>M-100 Dual-Element Microphone</p> <p>MH-31 A8J Hand Microphone</p> <p>YH-77STA Lightweight Stereo Headphone</p>	<p>MD-200 A8X Ultra High fidelity Desktop Microphone</p> <p>ATBK-100 Antenna Base Kit*3 (for Base operation on 6 m Band)</p> <p>CT-39A Packet Interface Cable</p> <p>MMB-90 Mobile Bracket</p>	<p>MD-100 A8X Desktop Microphone</p> <p>ATAS-25 Active-Tuning Antenna (Manual Type)</p> <p>ATAS-120A Active-Tuning Antenna*3 (Automatic Type)</p>
--	---	--	--

*1 USA and Asian versions only *2 VL-1000 and FH-2 cannot be used simultaneously. *3 VL-1000, FC-40, and ATAS-120A cannot be used simultaneously.

Ultra-Compact HF/VHF/UHF 100W All Mode Transceiver FT-857D

The world's smallest HF/VHF/UHF Mobile transceiver,
provides base station performance from an ultra-compact package



HF/50/144/430 MHz 100 W All Mode Transceiver

FT-857D (144 MHz 50 W/430 MHz 20 W)

Supplied Accessories: MH-31A8J Hand Microphone, MMB-82 Mobile Mounting Bracket, T9023225 DC Cable, YSK-857 Separation Kit

The FT-857D is the choice of experts
for high-performance mobile operation!



Large Main Tuning Dial and Outstanding Ergonomics

The FT-857D Ease of operation is enhanced by the large diameter 1.7" (Ø43 mm) Main Tuning Dial (10 Hz steps minimum), similar in size to the tuning knob of many base station rigs.

SELECT Knob and Quick Access Key

The SELECT knob permits "channelized" tuning in minimum steps of 1kHz on SSB/CW, or 5kHz on FM, for quick and easy tuning across the band. The most important keys are strategically placed about the front panel, for quick access.



High-Performance Receiver Design

Yaesu engineers have crafted the FT-857D frontend for a very low noise floor, along with a wide dynamic range. Extensive band-pass filtering in the front end, along with careful device selection and gain distribution, yield a receiver system that is ready for the strong-signal challenges of today's crowded bands!

Wide Frequency Coverage

Transmitter coverage of the HF, 50MHz, 144MHz, and 430MHz Amateur bands. The FT-857D also includes receive coverage on 100kHz to 56MHz, 76 to 108MHz, 118-164MHz, and 420-470MHz.

Upgrade with Collins® Mechanical Filters for SSB and CW (optional)

To enhance performance on both receive and transmit, high-performance Collins® Mechanical Filter options are available

- 2.3kHz, 10-pole YF-122S
- 500Hz, 7-pole YF-122C
- 300Hz, 7-pole YF-122CN



Rugged, High-Output Transmitter Design

The FT-857D utilizes rugged MOSFET Transistor devices in the power amplifier section, providing low noise, low distortion, and high reliability. Dependability is assured thanks to the extensive cooling system, featuring a thermostatically-controlled fan and aluminum die-cast chassis.

Useful and Convenient Functions

- Active Tuning Antenna System (ATAS-120A : Option)
- CW Operating Flexibility (Built-in Electric Keyer; CW Message Memory with Beacon Mode; CW Pitch; Side tone Control)
- Built-in Enhanced DSP Transceiver Performance.

OPTIONS

<p>●MH-59A8J Remote Control DTMF Microphone</p>	<p>The optional MH-59A8J Remote Microphone provides control of the major functions of the FT-857D from the microphone keypad. The MH-59A8J includes a rotary control knob for adjusting the operating frequency and the receiver volume level</p>	<p>●MH-36E8J DTMF Microphone</p>	<p>●MH-31A8J Hand Microphone</p>	<p>●M-1 Reference Microphone</p>	<p>●M-100 Dual-Element Microphone</p>	<p>●MD-200A8X Ultra High fidelity Desktop Microphone</p>	<p>●MD-100A8X Desktop Microphone</p>	<p>●YH-77STA Lightweight Stereo Headphone</p>
<p>●SSB YF-122S(2.3 kHz) Collins® Mechanical Filters</p>	<p>●CW YF-122C (500 Hz) CW YF-122CN (300 Hz) Collins® Mechanical Filters</p>	<p>●TCXO-9 0.5 ppm High-Stability Reference Oscillator</p>	<p>●CT-58 Band Data Cable for VL-1000*</p>	<p>●CT-39A Packet Interface Cable</p>	<p>●CT-62 CAT Computer Interface Cable</p>	<p>●SCU-17 USB Interface Unit (Requires CT-62)</p>		
<p>●VL-1000 HF-50 MHz 1 kW Linear Amplifier* (50 MHz; 500 W/USA Version) Automatic Antenna Tuner Built In</p>	<p>●VP-1000 VL-1000 Power Supply*</p>	<p>●YSK-857 Separation Kit</p>	<p>●FC-30 Bolt-on Automatic Antenna Tuner</p>	<p>●FC-40 Automatic Antenna Tuner (for Long wire antenna)</p>	<p>●ATAS-25 Active-Tuning Antenna (Manual Type)</p>	<p>●ATAS-120A Active-Tuning Antenna (Automatic Type)</p>		

*USA and Asian versions only

The Ultimate Compact FT-818ND Transceiver Wide-Band Coverage & Portability

Enjoy Outdoor Portable Operation with Full Features



HF/50/144/430MHz 6W All Mode Portable Transceiver

FT-818ND

Supplied Accessories: SBR-32 Ni-MH Battery Pack (9.6 V, 1900mAh), PA-48 Battery Charger, MH-31A8J Hand Microphone, FBA-28 Battery Case (holds 8 "AA" Alkaline cells [not included]), YHA-63 Whip Antenna for (50/144/430 MHz), DC Cable, Shoulder Strap

Best Performance for Outdoor Amateur Radio Operation

Ultimate Compact Transceiver with 6 Watts TX Power Output

Measures 5.31" (W) x 1.5" (H) x 6.5" (D) (135 x 38 x 165mm) and Light weight (under 2 pounds / 900g), the FT-818ND is an innovative, Multi-mode, wide-band, portable transceiver, within an ultra-compact body, providing up to 6W of stable and reliable output power. TX power level can be selected from four levels, 6W/5W/2.5W/1W. Outdoor operation can be enjoyed with the same convenience as a handheld transceiver. *6W(SSB/CW/FM), 2W(AM); 13.8VDC input *C4FM Digital mode is not supported

High Stability TCXO Built-In

Built-in TCXO provides ± 0.5 ppm high frequency stability (-10°C to +60°C) and maintains stable high-quality communication for SSB operation in the VHF/UHF band, and CW operation within a narrow band.

Ready to Operate from Various Sources of Power

Simple and convenient outdoor operation in any environment, the FT-818ND is ready to operate from multiple power sources:

- Supplied 1900mAh high-capacity Ni-MH battery pack (and battery charger)
- Supplied Alkaline Battery case, (8 alkaline "AA" cells not included).
- External 13.8VDC power source (External DC cable supplied)

Full featured CW Operation from a Portable

- CW "Semi Break-in": Receiver recovery Time (10ms to 2500ms in 10ms step)
- CW Reverse: Provides BFO injection LSB, instead of the default USB side.
- CW Pitch Control: CW side tone pitch adjustment (300Hz to 1000Hz in 50Hz steps)
- Built-in Electronic Keyer with speed adjustment (4WPM to 60WPM / 20CPM to 300CPM)

High Performance Collins® Mechanical Filters for SSB and CW (Optional)

To enhance performance on receiver, Collins® Mechanical Filter options are available.

Multi-Function Keys for Easy Feature Access

The "SELECT" knob, together with the "[A] [B] [C]" keys, provides ease of operation and quick efficient access to the many high-performance features.



Select Knob Multi-Function Keys

Two Antenna Connectors for Ease of Installation and Operation

The FT-818ND has two antenna terminals, a BNC and an M type. The desired antenna connection for each band may be selected in Menu Mode.

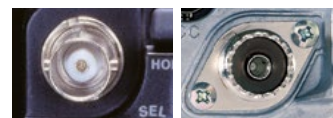

Front Panel (BNC) Rear panel (Type M)

Multi-Functional Display for Easy Operation

A wealth of information is available on the Multi-color display.



Spectrum Scope Monitor

Double Size Frequency Display

Valuable Features

- 208 Memory Channels
- Versatile Scan Features
- Equipped with dedicated Data Connector
- CAT System control interface

OPTIONS



- MH-36E8J DTMF Microphone
- MH-31A8J Hand Microphone
- M-1 Reference Microphone
- M-100 Dual-Element Microphone
- MD-200A8X Ultra High fidelity Desktop Microphone
- MD-100A8X Desktop Microphone
- YH-77STA Lightweight Stereo Headphone
- SSB YF-122S (2.3 kHz) Collins® Mechanical Filters
- CW YF-122C (500 Hz) CW YF-122CN (300 Hz) Collins® Mechanical Filters
- CT-62 CAT Computer Interface Cable
- CT-39A Packet Interface Cable
- SCU-17 USB Interface Unit (Requires CT-62)
- CSC-83 Soft Case
- SBR-32MH Ni-MH Battery Pack (9.6 V, 1900 mAh)
- PA-48B/C/U* Battery Charger
- ATAS-25 Active-Tuning Antenna (Manual Type)

* Depending on the version

DESKTOP MICROPHONE

Find New Pleasure in Creating Your Own Unique Vocal sound
Engineered for the Most Discriminating Ham Radio Operators

REFERENCE MICROPHONE

M-1

(Supplied Accessories)
AC adapter /
Microphone cable /
Treble Boost Cowling



DUAL-ELEMENT MICROPHONE

M-100

(Supplied Accessories)
Microphone cable /
Treble Boost Cowling



© Reference Microphone M-1

- Revolutionary dual microphone configuration features both dynamic and condenser elements
- Nine-band graphic equalizer for each microphone element
- TBC (Treble Boost Cowling) produces a unique tonal texture
- Long stroke Smooth Operating PTT key
- Solid aluminum die cast mic stand
- High visibility ON AIR LED
- Large display (featuring anti-reflective AR coating)
- Built-in record and playback feature
- Headphone output for real-time monitoring
- Built-in one-click Low-Cut filter
- Cannon-type(XLR) Output
- One-touch PTT keylock



M-1 Operating panel (Nine-band graphic equalizer)



Dual Microphone Configuration



Long stroke PTT key



M-100 Operating panel (One-touch, Low-Cut and High-Cut filters)

© Dual-Element Microphone M-100

- Revolutionary dual microphone configuration features both dynamic and condenser elements
- TBC (Treble Boost Cowling) produces a unique tonal texture
- Long stroke Smooth Operating PTT key
- High visibility ON AIR LED
- Built-in one-click Low-Cut and High-Cut filters
- One-touch PTT keylock

Specifications	M-1	M-100
Microphone elements	Dynamic and condenser microphones	Dynamic and condenser microphones
Supply Voltage	DC 5 V \pm 5 %	DC 5 V \pm 10 %
Frequency Response	30 - 17000 Hz	30 - 17000 Hz
Sensitivity	-60 dB(1kHz 0 dB = 1V/1Pa)	-60 dB(1kHz 0 dB = 1V/1Pa)
Mic Impedance	600 Ohms	600 Ohms
Headphone Output Impedance	16 Ohms(TYP)	-
Headphone Output Level	15 mW(TYP)	-
RX AUDIO IN(Input Level)	100 mVrms(TYP)	-
Dimensions(WxHxD)	5.5" x 11.0" x 6.0"(140 x 280 x 152 mm) *	5.0" x 11.0" x 5.4"(126x 280 x 137 mm) *
Weight(approx)	2.11 lbs (960g) w/o Cable	2.00 lbs (910g) w/o Cable

* Dimensions (H): Maximum with microphone flat

Applicable Models (M-1 and M-100)		
FTDX9000 Series	FTDX5000 Series	FTDX3000D
FTDX1200	FT-891	FT-450/D
FT-991/FT-991A	FT-857/D	FT-817/ND, FT-818ND
FT-2000/D	FT-950	FT-897/D
FT-920	FT-900	FT-847
FT-1000MP	FT-1000MP-MKV	FT-1000 *1
FT-990 *1	FT-850 *1	FT-840 *1
FT-747 *1	-	-

*1 Requires Optional *Power Supply Kit for M-100* for connecting of the M-100

ANTENNAS & TUNERS

Auto Active-Tuning Antenna

ATAS-120A



Yaesu patented ATAS™ (Active-Tuning Antenna System) provides HF/VHF/UHF coverage with automatic motorized tuning. Utilizing control signals from the transceiver microprocessor conducted via the coaxial cable, the ATAS internal motor adjusts the antenna length for best SWR. The ATAS covers the 7/14/21/28/50/144/430MHz bands.

■ Specifications

Frequency Range: 7/14/21/28/50/144/430 MHz
Amateur Bands
Height (Approx.): 4.59~5.24 ft (1.4~1.6 m)
Weight (Approx.): 1.98 lb (900 g)
Input Impedance: 50Ω
Max Input Power: 120W (SSB/CW, 50% Duty)
Matched SWR : Less than 2.0 : 1
(with proper counterpoise)



Active-Tuning Antenna

ATAS-25



The ATAS-25 is a manually-adjusted portable antenna ideal for field use with the HF Transceivers.

Designed for mounting on a standard camera tripod (1/4" stud), the ATAS-25 is tuned by sliding the shorting section of the loading coil assembly up or down and selecting the appropriate number of top sections. Counterpoise wires are supplied.

■ Specifications

Frequency Range: 7/14/21/28/50/144/430 MHz
Amateur Bands
Height (Approx.): Max. 7.2 ft (2.2 m) during Operation
Min. 1.96 ft (0.6 m) for Transporting
Weight (Approx.): 2.05 lb (930 g)
Input Impedance: 50Ω
Max Input Power: HF/50MHz : 100W (SSB/CW, 50% Duty)
50W (AM/FM)
144/430 MHz : 50W (ALL MODE)
Matched SWR : Less than 2.0 : 1

■ Supplied Items

Radiating Elements
Radial Element (for VHF band)
Radial Element (for UHF band)
Radial Wires (20 ft (6 m) ,
9.8 ft (3 m) & 6.6 ft (2 m) Length)
Spare Radial Wire (32.8 ft (10 m) Length)
Allen Wrench



© Innovative FC-30 (optional)
Automatic Antenna Tuner

The FC-30 is a high-speed, relay-controlled Automatic Antenna Tuner utilizing a combination of sixteen capacitors and nine low-loss coils to reduce SWR as presented to the FT-857D feedpoint.

Automatic Antenna Tuner

FC-30

■ Specifications

Frequency Range	: 1.8 ~ 30 MHz, 50 ~ 54 MHz
Input Impedance	: 50 Ω
Maximum Power	: 100 Watts
Matched SWR	: 1.5 : 1 or less
Tune-up Power	: 4 W ~ 60 W
Tune-up Time	: 5 seconds or less
Impedance Matching Range	: 1.8 ~ 30 MHz, 50 ~ 54 MHz: 16.5 Ω ~ 150 Ω
Impedance Matching Memories	: 100 channels
Input Voltage Requirement	: 13.8 V ± 15% (supplied from transceiver)
Operating Temperature Range	: 14° F ~ 122° F (-10°C ~ + 50°C)
Case Size (WHD)	: 3.1" x 1.8" x 10.2" (80 x 45 x 260 mm)
Weight	: 2.2 lb (1 kg)



© Automatic-Matching 200-Memory Antenna Tuner FC-40 (optional)

The FC-40 is a microprocessor-controlled antenna impedance matching network designed to provide all-amateur-band transmitting capability with the transceivers, when used with an end-fed random wire or long whip antenna.

Automatic-Matching 200-Memory Antenna Tuner

FC-40

■ Specifications

Frequency Range	: 1.8 - 54 MHz with 20+m end-fed wire, 7 - 54 MHz with YA-007 HF 2.5 m Mobile Whip Antenna
Input Impedance	: 50 Ω
Max Power	: 100 Watts (3 minutes Maximum Continuous TX)
Matched SWR	: 2.0:1 or less (if antenna is not a multiple of λ/2)
Tune-up Power	: 4 W ~ 60 W
Tune-up Time	: 8 seconds maximum
Impedance Matching Memories	: 200 channels
Power Supply	: 13.8 V ± 15% (supplied from transceiver)
Case Size (WHD)	: 9" x 7" x 2.1" (228 x 175 x 55 mm)
Weight	: 2.6 lb (1.2 kg)



© Automatic-Matching 100-Memory Antenna Tuner (optional)

The FC-50 is a microprocessor-controlled antenna tuner that is designed specifically for the FT-891. The FC-50 can be easily attached to the FT-891.

Automatic-Matching 100-Memory Antenna Tuner

FC-50

■ Specifications

Frequency Range	: 1.8 - 29.7MHz, 50 - 54MHz
Input Impedance	: 50 Ω
Maximum Power	: 100 Watts
Matched SWR	: 1.5 : 1 or less
Tune-up Power	: 4W - 60W
Tune-up Time	: 5 seconds or less
Impedance Matching Range	: 1.8 - 29.7MHz = 16Ω - 150Ω 50 - 54MHz = 25Ω - 100Ω
Impedance Matching Memories	: 100 channels
Input Voltage Requirement	: 13.8V ± 15 % (supplied from transceiver)
Case Size (WHD)	: 6.1" x 1.8" x 8.3" (155 x 45 x 210.5 mm)
Weight	: 3lb (1.35kg)



ROTATORS

G-2800DXA/DXC

Extra Heavy Duty
Supplied Accessories:
40 m Control cable with Connector*1



G-1000DXA/DXC
Medium / Heavy Duty



G-800DXA
G-800SA
Medium Duty



G-450A/C
Light Duty



G-550
Azimuth-Elevation Rotator

Models	G-2800DXA*2 G-2800DXC*2	G-1000DXA*2 G-1000DXC*2	G-800DXA*2	G-800SA	G-450A G-450C	G-5500
Recommended Application	Heavy-duty applications. Recommended for in-tower mounting.	Medium/heavy-duty for large HF arrays.	Medium-duty, for medium/large HF/VHF arrays.		Light to medium duty. Low price, perfect entry level rotator.	Azimuth-Elevation Combination for space communication.
Wind Load	3 m ²	2.2 m ²	2 m ²	2 m ²	1 m ²	1 m ²
K-Factor*3	950	230	180	180	100	60
Stationary Torque	25,000 kg/cm	6,000 kg/cm	4,000 kg/cm	4,000 kg/cm	3,000 kg/cm	AZ: 4,000 kg/cm EL: 4,000 kg/cm
Rotation Torque	2,500-800 kg/cm	1,100-600 kg/cm	1,100-600 kg/cm	800 kg/cm	600 kg/cm	AZ: 600 kg/cm EL: 1,400 kg/cm
Max. Vert. Load	300 kg	200 kg	200 kg	200 kg	100 kg	30 kg
Max. Vert. Intermittent Load	1,200 kg	800 kg	800 kg	800 kg	300 kg	100 kg
Backlash	0.2°	1°	1°	1°	0.5°	AZ: 1° EL: 1°
Mast Size	48-63 φ	38-63 φ	38-63 φ	38-63 φ	32-63 φ	AZ: 38-62 φ EL: 38-62 φ
360° Rotation Time	50-120 sec	40-100 sec	40-100 sec	55 sec	63 sec/50 Hz 51 sec/60 Hz	AZ: 70 sec/50 Hz 58 sec/60 Hz
180° Elevation Time	N/A	N/A	N/A	N/A	N/A	EL: 80 sec/50 Hz 67 sec/60 Hz
Boom Diameter	N/A	N/A	N/A	N/A	N/A	EL 32-43 φ
Direct control from YAESU HF radio*4	○	○	○	○	N/A	N/A
PC control*5	○	○	○	○	N/A	○
Rotator Diameter x Height	200 φ x 345	186 φ x 300	186 φ x 300	186 φ x 300	186 φ x 263	186 φ x 254 (W) x 350 (H)
Rotator Weight	6.5 kg	3.6 kg	3.6 kg	3.6 kg	3.5 kg	7.8 kg
Cable Requirement	6	6	6	5	5	2 x 6
Supply AC Voltage	DXA: 117/220 V DXC: 220 V (CE)	DXA: 117/220 V DXC: 220 V (CE)	117/220 V	117/220 V	A: 117/220 V C: 220 V (CE)	117/220 V

*1: USA version only

*2: On models with "DXA/DXC" suffix, rotation speed and torque will vary with the speed control setting.

*3: K-Factor: Multiply turning radius times weight; add K-Factor for each antenna in "Christmas Tree" installations.

*4: Depending on HF radios, please refer to catalog of YAESU HF radio.

*5: Requires optional GS-232B.

Rotator Unit Dimensions

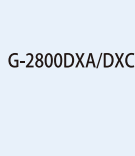

Rotator Attachment Dimensions

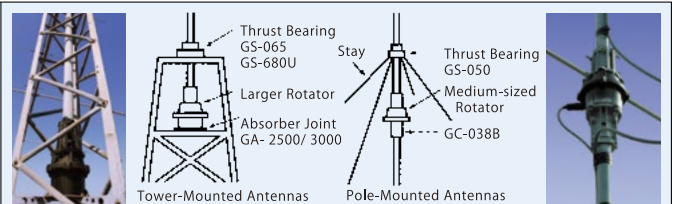
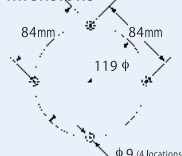

OPTIONS



● GS-232B
Computer Controller for all DXA/DXC Series and G-5500 Rotators



● GS-680U
Universal Bearing



● GS-065
Thrust Bearing



● GS-050
Thrust Bearing

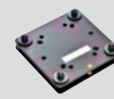

● GA-3000
Absorber Joint for G-2800DXA/DXC Rotators



● GC-038B/G
Mast Clamp (Brown/Green) for G-1000DXA/DXC, G-800DXA, G-800SA, and G-450A/C Rotators



● GC-048
Mast Clamp for G-2800DXA/DXC Rotators



● GL-33
Mast Adjustment Plate

● GA-2500

Absorber Joint for G-1000DXA/DXC, G-800DXA, G-800SA, and G-450A/C Rotators

● Control Cables

- 40 m Control cable with Connector
- 25 m Control cable with Connector

The New Standard of Excellence in Linear Amplifier Technology!

QUADRA SYSTEM

For a bold, clean signal from "Top Band" through the "Magic Band", the VL-1000/VP-1000 QUADRA SYSTEM belongs in your station!



HF / 50 MHz 1 kW Linear Amplifier*1 *2
VL-1000

48V 48A Switching Power Supply*1
VP-1000

Innovative Quadra Push-Pull RF Design for 1 kW of MOSFET Power

Yaesu's engineers have conquered the challenging task of providing high power output from 160 through 6 meters! Yaesu's exclusive Quadra Push-Pull amplifier design utilizes 8 rugged MRF-150 MOS FETs for years of reliable operation. Special attention to system grounding and RF bypassing ensures very low spurious emissions, even at maximum power output.

High-Performance Switching Relays with Automatic Maintenance Mode

Active Safety Protection Circuitry Assures Reliability and Quick Diagnosis of System Anomalies

Powerful 16-bit Control CPU Provides High-Speed Antenna Tuning with Extensive Memory and Multi-Band Memory Data Backup

The heart of the control circuitry of the VL-1000 is a 16-bit microprocessor, driven by a

Yaesu exclusive tuning algorithm in software. The on-board return-loss bridge analyzes the antenna system performance, instantly sending tuning instructions to the stepper motors in the antenna tuner section.

Large Dot-Matrix LCD Display Features World's First Panoramic SWR Monitor

The huge 7.6" x 1.7" (190 x 43 mm) dot-matrix LCD provides a wealth of amplifier-status information, including peak power output, average power output, voltage, current, and SWR data. Another Yaesu "World First" feature is the Panoramic SWR Monitor, which displays "before tuning" and "after tuning" SWR information for points across a band, providing you with instant data regarding antenna system performance.

Automatic Band Change for Quick QSY

When operating with most modern Yaesu transceivers, band data information can be transferred between transceiver and amplifier, allowing automatic amplifier band change

when you change bands on the latest Yaesu's HF / 50 MHz transceivers. The VL-1000 also provides Automatic Band Change via frequency-sensing circuit which instantly changes band when RF drive is first applied, for use with other excitors.

Direct Air Flow Cooling System Provides Efficient Dissipation of Heat

Twin high-speed fans, thermostatically controlled, quietly direct cooling air across the 76 vanes of the heat sink, efficiently transferring heat out of the amplifier compartment. Both the VL-1000 Amplifier and VP-1000 Power Supply have their own fan systems with independent thermostats.



Two Input and Four Output Antenna Jacks for Versatile Integration Opportunities Your Station

■ VL-1000 Specifications

General

Frequency Range: 1.8 - 54 MHz Amateur bands only
Power Output: (220V AC Input)
 1000W (SSB/CW)
 500W (FSK-RTTY/FM)
 250W (AM Carrier)
 (120V AC Input)
 500W (SSB/CW/FSK-RTTY/FM)
 125W (AM Carrier)
Input Voltages: DC+48V, DC+12V, DC-12V
Current Consumption: 48A(DC+48V), 2.8A(DC+12V), 0.1A(DC-12V)
Dimensions: 16.5" x 6.0" x 18.0"
 (including feet and switches)
Weight: 46.3 lb (21 kg)

Linear Amplifier Section

Input Power: 2,100 W max
RF Drive Power: 80 W(max) for full output
Spurious Emissions: Better than -50 dB (HF)
 Better than -70 dB (50 MHz band)
3rd-order intermodulation Products: At least -30 dB
Input impedance: 50 Ohms, unbalanced
Output impedance: 50 Ohms, unbalanced

Automatic Antenna Tuner

Matching Range: 16.7 Ω - 100 Ω (1.8 MHz band)
 25 Ω - 100 Ω (50 MHz band)
 16.7 Ω - 150 Ω (all other bands)
Maximum power: 1200 Watts
Insertion Loss: 0.5 dB
Matched SWR: Less than 1.5 : 1



■ VP-1000 Power Supply

Input Voltage: AC 100 - 240 V (Automatic switching)
Output Voltage: DC + 48 V, DC+12 V, DC-12 V
AC Current Drain: 13 A (AC 200 - 240 V @ 1kW output)
 15 A (AC 100 - 200 V @ 500W output)
Dimensions: 16.5" x 6.0" x 15.2"
 413 W x 151 H x 381D mm
 (including feet and switches)
Weight: 32.3 lb (14.6 kg)

Options



CT - 58 Band Data Cable (For FT - 991, FT - 857D)
CT - 118 Connection Cable (For FT - 450D, FTDX1200)
CT - 178 Connection Cable (For FTDX3000D)

*1 USA and Asian versions only *2 USA version is shipped from factory with 24 / 28 MHz Amateur bands operation disabled.





Series	HF-50MHz				
	FTDX9000 Series	FTDX9000 Series	FTDX5000		
					
Model number	FTDX 9000MP	FTDX 9000D	FTDX 5000MP Limited		
General	RX Frequency Range	30 kHz - 60 MHz (operating) 1.8 - 54 MHz (specified performance, Amateur bands only)	30 kHz - 60 MHz (operating) 1.8 - 54 MHz (specified performance, Amateur bands only)	30 kHz - 60 MHz (operating)* 1.8 - 54 MHz (specified performance, Amateur bands only)*	
	TX Frequency Ranges	1.8 - 54 MHz (Amateur bands only) 5.1675 MHz (Alaska Emergency Frequency : USA Only)	1.8 - 54 MHz (Amateur bands only) 5.1675 MHz (Alaska Emergency Frequency : USA Only)	1.8 - 54 MHz (Amateur bands only)	
	Emission Modes	A1A(CW),A3E(AM),J3E(LSB,USB),F3E(FM) F1B(RTTY),F1D(PACKET),F2D(PACKET)	A1A(CW),A3E(AM),J3E(LSB,USB),F3E(FM) F1B(RTTY),F1D(PACKET),F2D(PACKET)	A1A(CW),A3E(AM),J3E(LSB/USB),F3E(FM), F1B(RTTY),F1D(PACKET),F2D(PACKET)	
	Frequency Steps	1 Hz, 5 Hz, 10 Hz (CW, SSB, AM), 100Hz (FM)	1 Hz, 5 Hz, 10 Hz (CW, SSB, AM), 100Hz (FM)	1 Hz, 5 Hz, 10 Hz (CW, SSB, AM), 100Hz (FM)	
	Antenna Impedance	50 Ohms, unbalanced 16.7 - 150 Ohms, unbalanced (Tuner ON, 1.8 - 29.7 MHz Amateur bands) 25 - 100 Ohms, unbalanced (Tuner ON, 50 MHz Amateur band)	50 Ohms, unbalanced 16.7 - 150 Ohms, unbalanced (Tuner ON, 1.8 - 29.7 MHz Amateur bands) 25 - 100 Ohms, unbalanced (Tuner ON, 50 MHz Amateur band)	50 Ohms, unbalanced 16.7 - 150 Ohms, unbalanced (Tuner ON, 1.8 - 29.7 MHz Amateur bands) 25 - 100 Ohms, unbalanced (Tuner ON, 50 MHz Amateur band)	
	Operating Temperature Range	+14 ° F - +140 ° F (-10 ° C - +60 ° C)	+14 ° F - +140 ° F (-10 ° C - +60 ° C)	+14 ° F - +140 ° F (-10 ° C - +60 ° C)	
	Frequency Stability	±0.03 ppm (+14 ° F - +140 ° F / -10 ° C - +60 ° C, after 5 min)	±0.03 ppm (+14 ° F - +140 ° F / -10 ° C - +60 ° C, after 5 min)	±0.05 ppm (+14 ° F - +140 ° F / -10 ° C - +60 ° C, after 5 min)	
	Supply Voltage	100 VAC/200 VAC (Universal Input) 90 VAC~264 VAC	100 VAC/200 VAC (Universal Input) 90 VAC~264 VAC	90 VAC~264 VAC	
	Power Consumption (@ 117 VAC)	RX (no signal) 100 VA (Approx.) RX (signal present) 120 VA TX (400 W) 1000 VA (Approx.)	RX (no signal) 100 VA (Approx.) RX (signal present) 120 VA TX (200 W) 720 VA (Approx.)	RX (no signal) 70 VA RX (signal present) 80 VA TX (200 W) 720 VA	
	Dimensions (WxHxD)	20.4"x 6.5"x 17.3" (518 x 165 x 438.5 mm) w/o Knob	20.4"x 6.5"x 17.3" (518 x 165 x 438.5 mm) w/o Knob	18.2"x 5.3"x 15.3" (462 x 135 x 389 mm) w/o knob and connector	
	Weight (Approx.)	64 lb (29 kg) (w/o Power supply)	66 lb (30 kg)	46.3 lb (21 kg)	
	Transmitter	Power Output	10 W - 400 W (CW, SSB, FM, RTTY, PKT) Class-A (SSB) 10 W - 100 W 10 W - 100 W (AM)	5 W - 200 W (CW, SSB, FM, RTTY, PKT) Class-A (SSB) 5 W - 75 W 5 W - 50 W (AM)	10W - 200W (CW, SSB, FM, RTTY, PKT) Class-A (SSB) 10W - 75W 5W - 50W (AM)
		Modulation Types	J3E (SSB) : Balanced A3E (AM) : Low-Level (Early Stage) F3E (FM) : Variable Reactance	J3E (SSB) : Balanced A3E (AM) : Low-Level (Early Stage) F3E (FM) : Variable Reactance	J3E (SSB) : Balanced A3E (AM) : Low-Level (Early Stage) F3E (FM) : Variable Reactance
		Maximum FM Deviation	± 5.0 kHz / ± 2.5 kHz	± 5.0 kHz / ± 2.5 kHz	± 5.0 kHz / ± 2.5 kHz
		Harmonic Radiation	Better than -60 dB (1.8 - 30 MHz Amateur bands) Better than -70 dB (50 MHz Amateur Band)	Better than -60 dB (1.8 - 30 MHz Amateur bands) Better than -70 dB (50 MHz Amateur Band)	Better than -60 dB (1.8 - 30 MHz Amateur bands) Better than -66 dB (50 MHz Amateur band)
		SSB Carrier Suppression	At least 70 dB below peak output	At least 70 dB below peak output	At least 60 dB below peak output
Undesired Sideband Suppression		At least 80 dB below peak output	At least 80 dB below peak output	At least 60 dB below peak output	
3rd-order IMD (14 MHz) ※PEP		-31 dB (400 W) -50 dB (100 W Class-A)	-31 dB (200 W) -50 dB (75 W Class-A)	-31 dB (14 MHz, 200 W) -40 dB (14 MHz, 75 W Class-A)	
Bandwidth		3.0 kHz (LSB, USB), 500 Hz (CW) 6.0 kHz (AM), 16 kHz (FM)	3.0 kHz (LSB, USB), 500 Hz (CW) 6.0 kHz (AM), 16 kHz (FM)	3.0 kHz (LSB, USB), 500 Hz (CW) 6.0 kHz (AM), 16 kHz (FM)	
Audio Response (SSB)		Not more than -6 dB from 300 to 2700 Hz	Not more than -6 dB from 300 to 2700 Hz	Not more than -6 dB from 300 to 2700 Hz	
Microphone Impedance		600 Ohms (200 to 10 k Ohms)	600 Ohms (200 to 10 k Ohms)	600 Ohms (200 to 10 k Ohms)	
Circuit Type		Triple-conversion superheterodyne	Triple-conversion superheterodyne	VFO-A : Double - conversion superheterodyne VFO-B : Triple - conversion superheterodyne	
Receiver		Intermediate Frequencies	VFO A 40.455 MHz VFO B 40.450 MHz 30 kHz (24 kHz for FM)	VFO A 40.455 MHz VFO B 40.450 MHz 30 kHz (24 kHz for FM)	VFO A 9.000 MHz VFO B 40.455 MHz 30 kHz (24 kHz for AM/FM) 455 kHz 30 kHz (24 kHz for AM/FM)
	Sensitivity	SSB/CW (2.4 kHz, 10 dB S+N/N) 0.2 μV (1.8 - 30 MHz Amateur bands) 0.125 μV (50 MHz Amateur band) 2 μV (0.1 - 30 MHz) AM (6 kHz, 10 dB S+N/N, 30 % MOD @400 Hz) 3.2 μV (0.1 - 1.8 MHz) 2 μV (1.8 - 30 MHz) 1 μV (50 MHz Amateur band) FM (12dB SINAD) 0.5 μV (28 MHz Amateur band) 0.35 μV (50 MHz Amateur band) ※ IPO "off"	SSB/CW (2.4 kHz, 10 dB S+N/N) 0.2 μV (1.8 - 30 MHz Amateur bands) 0.125 μV (50 MHz Amateur band) 2 μV (0.1 - 30 MHz) AM (6 kHz, 10 dB S+N/N, 30 % MOD @400 Hz) 3.2 μV (0.1 - 1.8 MHz) 2 μV (1.8 - 30 MHz) 1 μV (50 MHz Amateur band) FM (12dB SINAD) 0.5 μV (28 MHz Amateur band) 0.35 μV (50 MHz Amateur band) ※ IPO "off"	SSB/CW (2.4 kHz, 10 dB S+N/N) 2 μV (0.5 - 1.8 MHz, IPO1) 0.2 μV (1.8 - 30 MHz, AMP2)* 0.125 μV (50 - 54 MHz, AMP2) AM (6 kHz, 10 dB S+N/N, 30 % modulation @400 Hz) 6 μV (0.5 - 1.8 MHz, IPO1) 2 μV (1.8 - 30 MHz, AMP2)* 1 μV (50 - 54 MHz, AMP2) FM (BW : 15 kHz, 12 dB SINAD) 0.5 μV (28 - 30 MHz, AMP2) 0.35 μV (50 - 54 MHz, AMP2) There is no specification in frequency ranges not listed.	
	Selectivity	Mode -6 dB CW/RTTY/PKT 0.5 kHz or better 0.75 kHz or less SSB 2.4 kHz or better 3.6 kHz or less AM 9 kHz or better 18 kHz or less FM 15 kHz or better 25 kHz or less	Mode -6 dB CW/RTTY/PKT 0.5 kHz or better 0.75 kHz or less SSB 2.4 kHz or better 3.6 kHz or less AM 9 kHz or better 18 kHz or less FM 15 kHz or better 25 kHz or less	Mode -6 dB CW 0.5 kHz or better 0.75 kHz or less LSB, USB 2.4 kHz or better 3.6 kHz or less AM 6 kHz or better 15 kHz or less FM 12 kHz or better 30 kHz or less	
	Image Rejection	70 dB or better (1.8 - 30 MHz Amateur bands) 60 dB or better (50 MHz Amateur band)	70 dB or better (1.8 - 30 MHz Amateur bands) 60 dB or better (50 MHz Amateur band)	70 dB or better (1.8 - 30 MHz Amateur bands, VRF: ON) 60 dB or better (50 MHz Amateur band)	
	Maximum Audio Output	2.5 W into 4 Ohms with 10% THD	2.5 W into 4 Ohms with 10% THD	2.5 W into 4 Ohms with 10% THD	
	Audio Output Impedance	4 to 8 Ohms (4 Ohms: nominal)	4 to 8 Ohms (4 Ohms: nominal)	4 to 8 Ohms (4 Ohms: nominal)	
	Conducted Radiation	Less than 4 nW	Less than 4 nW	Less than 4 nW * Except the 9 MHz.	

● Specifications are subject to change, in the interest of technical improvement, without notice or obligation, and are guaranteed only within the amateur bands.

SPECIFICATIONS

Series	HF-50MHz		
	FT DX 3000D	FT DX 1200	FT-891
			
Model number	FT DX 3000D	FT DX 1200	FT-891
RX Frequency Range	30 kHz - 56 MHz (operating) 1.8 - 54 MHz (specified performance, Amateur bands only)	30 kHz - 56 MHz (operating) 1.8 - 54 MHz (specified performance, Amateur bands only)	30 kHz - 55.999995 MHz (Amateur bands only)
TX Frequency Ranges	1.8 - 54 MHz (Amateur bands only)	1.8 - 54 MHz (Amateur bands only)	1.8 - 54 MHz (Amateur bands only)
Emission Modes	A1A (CW), A3E (AM), J3E (LSB, USB), F3E (FM), F1 B (RTTY), G1B (PSK)	A1A (CW), A3E (AM), J3E (LSB, USB), F3E (FM), F1 B (RTTY), G1B (PSK)	A1A (CW), A3E (AM), J3E (LSB, USB), F2D, F3E (FM)
Frequency Steps	1 Hz, 5 Hz, 10 Hz (CW, SSB, AM), 100 Hz (FM)	1 Hz, 5 Hz, 10 Hz (CW, SSB, AM), 100 Hz (FM)	2/5/10 Hz (SSB, CW), 10/100 Hz (AM, FM)
Antenna Impedance	50 Ohms, unbalanced 16.7 - 150 Ohms, unbalanced (Tuner ON, 1.8 - 29.7 MHz Amateur bands) 25 - 100 Ohms, unbalanced (Tuner ON, 50 MHz Amateur band)	50 Ohms, unbalanced 16.7 - 150 Ohms, unbalanced (Tuner ON, 1.8 - 29.7 MHz Amateur bands) 25 - 100 Ohms, unbalanced (Tuner ON, 50 MHz Amateur band)	50 Ohms, unbalanced
Operating Temperature Range	+14 °F - +122 °F (-10 °C - +50 °C)	+14 °F - +122 °F (-10 °C - +50 °C)	+14 °F - +122 °F (-10 °C - +50 °C)
Frequency Stability	±0.5 ppm (14°F/+122°F/-10°C/+50°C, after 1 min)	±0.5 ppm (14°F/+122°F/-10°C/+50°C, after 1 min)	±0.5 ppm (14°F/+122°F/-10°C/+50°C, after 1 min)
Supply Voltage	DC 13.8 V ±10% (Negative Ground)	DC 13.8 V ±10% (Negative Ground)	DC 13.8 V ±15% (Negative Ground)
Power Consumption	RX(no signal) 1.8 A RX(signal present) 2.1 A TX(100 W) 23 A	RX(no signal) 1.8 A RX(signal present) 2.1 A TX(100 W) 23 A	Receive: 2.0 A (signal present) Transmit: 23 A
Dimensions (WxHxD)	14.4" x 4.5" x 12.3" (365 x 115 x 312 mm)	14.4" x 4.5" x 12.3" (365 x 115 x 312 mm)	6.1" x 2.0" x 8.6" (155 x 52 x 218 mm) w/o knobs
Weight (Approx.)	22.0 lb (10 kg)	20.9 lb (9.5 kg)	4.18 lb (1.9 kg)
Power Output	5 - 100 W (2 - 25 W AM carrier)	5 - 100 W (2 - 25 W AM carrier)	100 W (SSB/CW/FM) 40 W (AM)
Modulation Types	J3E (SSB) : Balanced A3E (AM) : Low-Level (Early Stage) F3E (FM) : Variable Reactance	J3E (SSB) : Balanced A3E (AM) : Low-Level (Early Stage) F3E (FM) : Variable Reactance	J3E (SSB) : Balanced A3E (AM) : Low-Level (Early Stage) F3E (FM) : Variable Reactance
Maximum FM Deviation	±5.0 kHz / ±2.5 kHz	±5.0 kHz / ±2.5 kHz	±5.0 kHz / ±2.5 kHz
Harmonic Radiation	Better than -60 dB (1.8 - 30 MHz Amateur bands: Harmonics) Better than -50 dB (1.8 - 30 MHz Amateur bands: Others) Better than -63 dB (50 MHz Amateur band)	Better than -60 dB (1.8 - 30 MHz Amateur bands: Harmonics) Better than -50 dB (1.8 - 30 MHz Amateur bands: Others) Better than -63 dB (50 MHz Amateur band)	Better than -50 dB (1.8 MHz - 30 MHz Amateur bands) Better than -63 dB (50 MHz Amateur bands)
SSB Carrier Suppression	At least 60 dB below peak output	At least 60 dB below peak output	At least 50 dB below peak output
Undesired Sideband Suppression	At least 60 dB below peak output	At least 60 dB below peak output	At least 50 dB below peak output
3rd-order IMD (14 MHz) *PEP	-31dB (100W)	-31dB (100W)	—
Bandwidth	3.0 kHz (LSB, USB), 500 Hz (CW) 6.0 kHz (AM), 16 kHz (FM)	3.0 kHz (LSB, USB), 500 Hz (CW) 6.0 kHz (AM), 16 kHz (FM)	3.0 kHz (LSB, USB), 500 Hz (CW) 6.0 kHz (AM), 16 kHz (FM)
Audio Response (SSB)	Not more than -6 dB from 300 to 2700 Hz	Not more than -6 dB from 300 to 2700 Hz	Not more than -6 dB from 300 to 2700 Hz
Microphone Impedance	600 Ohms (200 to 10 k Ohms)	600 Ohms (200 to 10 k Ohms)	600 Ohms (200 to 10 k Ohms)
Circuit Type	Double-conversion superheterodyne	Triple-conversion superheterodyne	Triple-conversion Superheterodyne (SSB/CW/AM) Double Conversion Superheterodyne (FM)
Intermediate Frequencies	1st. Frequencies 9.000MHz 2nd. Frequencies 30kHz (24 kHz for AM/FM) 3rd. Frequencies —	40.455MHz 455kHz 30kHz (24 kHz for AM/FM)	1st. 69.450 MHz 2nd. 450 kHz 3rd. 24 kHz (SSB/CW/AM)
Sensitivity	SSB/CW (BW: 2.4 kHz, 10 dB S+N/N) 0.16 μV (1.8 - 30 MHz, AMP2) 0.125 μV (50 - 54 MHz, AMP2) AM (BW: 6 kHz, 10 dB S+N/N, 30% modulation @400 Hz) 2 μV (0.5 - 1.8 MHz, AMP2) 2 μV (1.8 - 30 MHz, AMP2) 1 μV (50 - 54 MHz, AMP2) FM (BW: 15 kHz, 12 dB SINAD) 0.5 μV (28 - 30 MHz, AMP2) 0.35 μV (50 - 54 MHz, AMP2) There is no specification in frequency ranges not listed.	SSB/CW (BW: 2.4 kHz, 10 dB S+N/N) 0.16 μV (1.8 - 30 MHz, AMP2) 0.125 μV (50 - 54 MHz, AMP2) AM (BW: 6 kHz, 10 dB S+N/N, 30% modulation @400 Hz) 2 μV (0.5 - 1.8 MHz, AMP2) 2 μV (1.8 - 30 MHz, AMP2) 1 μV (50 - 54 MHz, AMP2) FM (BW: 15 kHz, 12 dB SINAD) 0.5 μV (28 - 30 MHz, AMP2) 0.35 μV (50 - 54 MHz, AMP2) There is no specification in frequency ranges not listed.	SSB/CW (S/N 10 dB) 0.16 μV (1.8 - 30 MHz) 0.16 μV (50 - 54 MHz) (S/N 10 dB) AM (S/N 10 dB) 5 μV (0.5 - 1.8 MHz) 1.6 μV (1.8 - 30 MHz) 1.6 μV (50 - 54 MHz) (12 dB SINAD) FM (12 dB SINAD) 0.35 μV (29 MHz, 50 - 54 MHz)
Selectivity	Mode -6 dB -60 dB CW/RTTY/PKT 0.5 kHz or better 0.75 kHz or less SSB 2.4 kHz or better 3.6 kHz or less AM 6 kHz or better 15 kHz or less FM 12 kHz or better 25 kHz or less	Mode -6 dB -60 dB CW/RTTY/PKT 0.5 kHz or better 0.75 kHz or less SSB 2.4 kHz or better 3.6 kHz or less AM 6 kHz or better 15 kHz or less FM 12 kHz or better 30 kHz or less	Mode -6 dB -60 dB SSB/CW 2.4 kHz or better 3.6 kHz or less CW-N 500 Hz or better 750 Hz or less AM 6 kHz or better 15 kHz or less FM 12 kHz or better 30 kHz or less (-50dB) FM-N 9 kHz or better 25 kHz or less (-50dB)
Image Rejection	70 dB or better (1.8 - 30 MHz Amateur bands) 60 dB or better (50 MHz Amateur band)	70 dB or better (1.8 - 30 MHz Amateur bands) 60 dB or better (50 MHz Amateur band)	70 dB or better (HF/50 MHz Amateur bands)
Maximum Audio Output	2.5 W into 4 Ohms with 10% THD	2.5 W into 4 Ohms with 10% THD	2.5 W into 4 Ohms with 10% THD
Audio Output Impedance	4 to 8 Ohms (4 Ohms : nominal)	4 to 8 Ohms (4 Ohms : nominal)	4 to 16 Ohms (8 Ohms : nominal)
Conducted Radiation	Less than 4 nW	Less than 4 nW	Less than 4 nW

● Specifications are subject to change, in the interest of technical improvement, without notice or obligation, and are guaranteed only within the amateur bands.

Series	HF-50MHz	HF-UHF CW/SSB/AM/FM/C4FM	HF-UHF CW/SSB/AM/FM	
	FT-450D	FT-991A	FT-857D	FT-818ND
				
Model number	FT-450D	FT-991A	FT-857D	FT-818ND
RX Frequency Range	30 kHz - 56 MHz (operating) 1.8 - 54 MHz (specified performance, Amateur bands only)	30 kHz - 56 MHz, 118 - 164 MHz, 420 - 470 MHz (operating) 1.8 - 54 MHz, 144 - 148MHz, 430 - 450 MHz (specified performance, Amateur bands only)	100 kHz - 56 MHz, 76 - 108 MHz (WFM only), 118 - 164 MHz, 420 - 470 MHz (operating)	100kHz - 56MHz 76MHz - 154MHz, 420MHz - 470MHz
TX Frequency Ranges	1.8 - 54 MHz (Amateur bands only)	1.8 - 54 MHz, 144 - 148MHz, 430 - 450 MHz (Amateur bands only)	1.8 - 54 MHz, 144 - 148 MHz, 430 - 450 MHz (Amateur bands only) 5.1675MHz Alaska Emergency Frequency (Depending on the version)	1.8 - 54 MHz, 144 - 148 MHz, 430 - 450 MHz (Amateur bands only) 5.1675MHz Alaska Emergency Frequency (Depending on the version)
Emission Modes	A1A (CW), A3E (AM), J3E (LSB, USB), F3E (FM)	A1A (CW), A3E (AM), J3E (LSB, USB), F2D, F3E (FM), F7W (C4FM)	A1 (CW), A3 (AM), A3J (LSB, USB), F3 (FM), F1 (9600 bps packet), F2 (1200 bps packet)	A1A (CW), A3E (AM), J3E (LSB/USB), F3E (FM), F1D (9600 bps packet), F2D (1200 bps packet)
Frequency Steps	1 Hz, 10 Hz, 20 Hz (CW, SSB), 100 Hz, 200 Hz (AM, FM)	5 / 10 Hz (SSB, CW, AM), 100 Hz (FM, C4FM)	10Hz(CW/SSB), 100Hz(AM, FM, WFM)	10Hz (CW/SSB), 100Hz (AM/FM)
Antenna Impedance	50 Ohms, unbalanced 16.5 - 150 Ohms, unbalanced (Tuner ON, 1.8 - 50 MHz Amateur bands)	50 Ohms, unbalanced 16.7 - 150 Ohms, unbalanced (Tuner ON, 1.8 - 30 MHz Amateur bands) 25 - 100 Ohms, unbalanced (Tuner ON, 50 MHz Amateur band)	50 Ohms, unbalanced	50 ohms, unbalanced (Front: Type BNC, Rear: Type M)
Operating Temperature Range	+14 °F - +122 °F (-10 °C - +50 °C)	+14 °F - +122 °F (-10 °C - +50 °C)	+14 °F - +140 °F (-10 °C - +60 °C)	+14 °F to +140 °F (-10 °C to +60 °C)
Frequency Stability	±1 ppm /hour (@77°F/+25°C, after warm-up)	±0.5 ppm (@14°F - +122°F/-10°C - +50°C, after 1 min)	±4 ppm from 1 min. to 60 min after power on @25 °C ±0.5 ppm/1 hour @25 °C, after warmup (with optional TCXO-9)	±0.5ppm (CW/SSB/AM), ±1 kHz ±0.5ppm (FM)
Supply Voltage	DC 13.8 V ±10 % (Negative Ground)	DC 13.8 V ±15 % (Negative Ground)	Nominal: 13.8 VDC ±15 %, (Negative Ground)	Nominal: 13.8VDC ±15 %, Negative Ground Operating: 8.0 - 16.0V, Negative Ground FBA-28 (w/8 "AA" Alkaline Cells): 12.0V SBR-32MH (Ni-MH Battery Pack): 9.6V
Power Consumption	RX(signal present) 1.5A TX(100 W) 22 A	RX (no signal): 1.8 A RX (signal present): 2.2 A TX: 23 A (HF/50MHz 100 W), 15 A (144/430MHz 50 W)	Squelched : 600 mA (Approx.) Receive : 1 A Transmit : 22 A	Squelched: 300mAh (Approx.) Receive: 450mA Transmit: 2.4A (HF/50MHz/144MHz), 2.7A (430MHz)
Dimensions (WxHxD)	9" x 3.3" x 8.5" (229 x 84 x 217 mm)	9" x 3.2" x 10" (229 x 80 x 253 mm)	6.1" x 2" x 9.2" (155 x 52 x 233 mm)	5.31" x 1.5" x 6.50" (135 x 38 x 165mm)
Weight (Approx.)	8.8 lb (4.0 kg)	9.5 lbs (4.3 kg)	4.6 lb (2.1 kg)	1.98 lbs (900g) w/o battery, antenna, and Microphone 6 W (SSB/CW/FM), 2 W (AM Carrier) @13.8 V
Power Output	5 - 100 W (2 - 25 W AM carrier)	SSB/CW/FM AM Carrier 1.8 - 54 MHz: 100 W 25 W 144/430 MHz: 50 W 12.5 W (Amateur bands only)	SSB/CW/FM AM Carrier 1.8 - 54 MHz: 100 W 25 W 144 MHz: 50 W 12.5 W 430 MHz: 20 W 5 W (Amateur bands only)	6 W (SSB/CW/FM), 2 W (AM Carrier) @13.8 V
Modulation Types	J3E (SSB) : Balanced A3E (AM) : Low-Level (Early Stage) F3E (FM) : Variable Reactance	J3E (SSB) : Balanced A3E (AM) : Low-Level (Early Stage) F3E (FM) : Variable Reactance F7W (C4FM) : 4-level FSK	SSB : Balanced Modulator AM : Low Level (Early Stage) FM : Variable Reactance	SSB: Balanced Modulator AM: Early Stage (Low Level) FM: Variable Reactance
Maximum FM Deviation	±5.0 kHz / ±2.5 kHz	±5.0 kHz / ±2.5 kHz	±5.0 kHz / ±2.5 kHz	±5kHz (FM-N: ±2.5kHz)
Harmonic Radiation	Better than -60 dB (1.8 - 30 MHz Amateur bands) Better than -70 dB (50 MHz Amateur band)	Better than -50 dB (1.8 - 30 MHz Amateur bands) Better than -63 dB (1.8 - 30 MHz Amateur bands, above 30MHz)* Better than -63 dB (50 MHz Amateur band) Better than -60 dB (144 MHz, 430 MHz Amateur bands)	-50 dB (1.8-29.7 MHz Amateur bands) -60 dB (50/144/430 MHz Amateur bands)	-50dB (1.8-29.7MHz Amateur bands) -60dB (50/144/430MHz Amateur bands)
SSB Carrier Suppression	At least 60 dB below peak output	At least 50 dB below peak output	At least 40 dB below peak output	At least 40dB below peak output
Undesired Sideband Suppression	At least 60 dB below peak output	At least 50 dB below peak output	At least 50 dB below peak output	At least 50dB below peak output
3rd-order IMD (14 MHz) ※PEP	—	—	-31 dB (100 W)	—
Bandwidth	3.0 kHz (LSB, USB), 500 Hz (CW) 6.0 kHz (AM), 16 kHz (FM)	3.0 kHz (LSB, USB), 500 Hz (CW) 6.0 kHz (AM), 16 kHz (FM, C4FM)	3.0 kHz (LSB, USB), 500 Hz (CW) 6.0 kHz (AM), 16 kHz (FM)	3.0kHz (LSB, USB), 500Hz (CW) 6.0kHz (AM), 16kHz (FM)
Audio Response (SSB)	Not more than -6 dB from 300 to 2400 Hz	Not more than -6 dB from 300 to 2700 Hz	400 Hz - 2600 Hz (-6 dB)	400Hz-2600Hz (-6dB)
Microphone Impedance	600 Ohms (200 to 10 k Ohms)	600 Ohms (200 to 10 k Ohms)	600 Ohms (200 to 10 k Ohms)	600 Ohms (200 to 10k Ohms)
Circuit Type	Double-conversion superheterodyne	Triple-conversion superheterodyne (SSB/CW/AM) Double-conversion superheterodyne (FM/C4FM)	Double-conversion superheterodyne (SSB/CW/AM/FM) Superheterodyne (WFM)	Double-Conversion Superheterodyne (SSB/CW/AM/FM) Single-Conversion Superheterodyne (WFM)
Intermediate Frequencies	1st. Frequencies 67.899MHz 2nd. Frequencies 24kHz 3rd. Frequencies —	1st. 69.450 MHz 2nd. 9.000 MHz (SSB/CW/AM); 450 kHz (FM/C4FM) 3rd. 24 kHz (SSB/CW/AM)	1st. 68.33 MHz (SSB/CW/AM/FM); 10.7 MHz (WFM) 2nd. 455kHz —	1st: 68.33MHz (SSB/CW/AM/FM); 10.7MHz (WFM) 2nd: 455kHz —
Sensitivity	SSB/CW (BW: 2.4 kHz, 10 dB S+N/N) 0.25 μV (1.8 - 20 MHz) 0.25 μV (3.5 - 30 MHz) 0.20 μV (50 - 54 MHz) AM (BW: 6 kHz, 10 dB S+N/N, 30% modulation @400 Hz) 2 μV (1.8 - 2.0 MHz) 2 μV (3.5 - 30 MHz) 1 μV (50 - 54 MHz) FM (BW: 10 kHz, 12 dB SINAD) 0.50 μV (28 - 30 MHz) 0.30 μV (50 - 54 MHz) There is no specification in frequency ranges not listed.	SSB/CW (BW: 2.4 kHz, 10 dB S+N/N) 0.158 μV (1.8 - 30 MHz, AMP 2) 0.125 μV (50 - 54 MHz, AMP 2) 0.11 μV (144 - 148 MHz) 0.11 μV (430 - 450 MHz) AM (BW: 6 kHz, 10 dB S+N/N, 30% modulation @400 Hz) 5 μV (0.5 - 1.8 MHz, AMP 2) 1.6 μV (1.8 - 30 MHz, AMP 2) 1.25 μV (50 - 54 MHz, AMP 2) FM (BW: 15 kHz, 12 dB SINAD) 0.35 μV (28 - 30 MHz, AMP 2) 0.35 μV (50 - 54 MHz, AMP 2) 0.18 μV (144 - 148 MHz) 0.18 μV (430 - 440 MHz) There is no specification for frequency ranges not listed.	SSB/CW (10 dB S+N/N) 0.2 μV (1.8 - 30 MHz), 0.125 μV (50 - 54 MHz), 0.125 μV (144 - 148 MHz/430 - 440 MHz) AM (10 dB S+N/N, 30% modulation @400 Hz) 32 μV (0.1 - 1.8 MHz), 2 μV (1.8 - 30 MHz), 1 μV (50 - 54 MHz) FM (12 dB SINAD) 0.5 μV (28 - 30 MHz), 0.2 μV (50 - 54 MHz), 0.16 μV (144 - 148 MHz/430 - 440 MHz)	SSB/CW 0.25 μV (1.8 - 28 MHz) 0.25 μV (1.8 - 30 MHz) 0.2 μV (50 - 54 MHz) 0.125 μV (144/430 MHz bands) AM 32 μV (0.5 - 1.8 MHz) 2 μV (1.8 - 28 MHz) 2 μV (28 - 30 MHz) 2 μV (50 - 54 MHz) FM 0.5 μV (28 - 30 MHz) 0.32 μV (50 - 54 MHz) 0.2 μV (144/430 MHz bands) (IPO, ATT off, SSB/CW/AM = 10dB S/N, FM = 12dB SINAD)
Selectivity	Mode -6 dB -60 dB CW-N 0.25 kHz or better 0.7 kHz or less SSB 2.2 kHz or better 4.5 kHz or less AM 6 kHz or better 20 kHz or less FM 15 kHz or better 30 kHz or less FM-N 9 kHz or better 25 kHz or less	Mode -6 dB -60 dB CW 0.5 kHz or better 0.75 kHz or less SSB 2.4 kHz or better 3.6 kHz or less AM 6 kHz or better 15 kHz or less FM 12 kHz or better 30 kHz or less (-50dB)	Mode -6 dB -60 dB SSB/CW 2.2 kHz 4.5 kHz AM 6 kHz 20 kHz FM 15 kHz 30 kHz FM-N 9 kHz 25 kHz SSB (optional YF-122S installed) 2.3 kHz 4.7 kHz (-66dB) CW (optional YF-122C installed) 500 Hz 2.0 kHz CW (optional YF-122CN installed) 300 Hz 1.0 kHz	(Mode) (-6dB) (-60dB) SSB/CW 2.2kHz 4.5kHz AM 6kHz 20kHz FM 15kHz 30kHz FM-N 9kHz 25kHz SSB 2.3kHz 4.7kHz (-66dB) *optional YF-122S installed CW 500Hz 2.0kHz *optional YF-122C installed CW 300Hz 1.0kHz *optional YF-122CN installed
Image Rejection	80 dB or better (1.8 - 30 MHz Amateur bands) 65 dB or better (50 MHz Amateur band)	70 dB or better (HF / 50 MHz Amateur bands) 60 dB or better (144 / 430 MHz Amateur bands)	70 dB or better (HF / 50 MHz Amateur bands) 60 dB or better (144 / 430 MHz Amateur bands)	70dB or better (HF / 50MHz Amateur bands) 60dB or better (144 / 430MHz Amateur bands)
Maximum Audio Output	2.2 W into 4 Ohms with 10% THD	2.5 W into 4 Ohms with 10% THD	2.5 W into 4 Ohms with 10% THD or less	1.0W (8 Ohms, 10% THD or less)
Audio Output Impedance	4 to 16 Ohms (8 Ohms : nominal)	4 to 8 Ohms (4 Ohms: nominal)	4 to 16 Ohms (8 Ohms: nominal)	4 - 16 ohms
Conducted Radiation	Less than 4 nW	Less than 4 nW * European version only	Less than 4 nW	less than 4 nW

● Specifications are subject to change, in the interest of technical improvement, without notice or obligation, and are guaranteed only within the amateur bands.

About this brochure: We have made this brochure as comprehensive and factual as possible. We reserve the right, however, to make changes at any time in equipment, optional accessories, specifications, model numbers, and availability. Precise frequency range may be different in some countries. Some accessories shown herein may not be available in some countries. Some information may have been updated since the time of printing; please check with your Authorized Yaesu Dealer for complete details.

YAESU
The radio

YAESU MUSEN CO., LTD. <http://www.yaesu.com/jp>

Tennozu Parkside Building
2-5-8 Higashi-Shinagawa, Shinagawa-ku, Tokyo 140-0002, Japan

YAESU USA <http://www.yaesu.com>

US Headquarters 6125 Phyllis Drive, Cypress, CA 90630, U.S.A.

YAESU UK <http://www.yaesu.co.uk>

Unit 12, Sun Valley Business Park, Winnall Close
Winchester, Hampshire, SO23 0LB, U.K.

2018.0410HN(U/EXP/EU) B9200838 Printed in Japan

