



INSTRUCTION MANUAL

VHF TRANSCEIVER

IC-F3/S

UHF TRANSCEIVER

IC-F4/S

This device complies with Part 15 of the FCC Rules. Operation is subject to the condition that this device does not cause harmful interference.

A black rectangular box with white text. The text reads 'SmarTrunk II™' on the top line and 'Compatible' on the bottom line. The box is framed by thin white lines at the top and bottom.

SmarTrunk II™
Compatible

Icom Inc.

IMPORTANT

READ ALL INSTRUCTIONS carefully and completely before using the transceiver.

SAVE THIS INSTRUCTION MANUAL. This manual contains important safety and operating instructions for the **IC-F3, IC-F3S, IC-F4 and IC-F4S.**

CAUTIONS

NEVER allow the antenna to come close to, or touch, exposed body parts, especially the face or eyes while transmitting.

NEVER disassemble the transceiver. Incorrect reassembly may result in a fire hazard or electric shock.

NEVER operate the transceiver near unshielded electrical blasting caps or in an explosive area.

AVOID the use of chemical agents such as benzene or alcohol when cleaning—use a water-dampened cloth only.

For U.S.A. only

Caution: Changes or modifications to this transceiver, not expressly approved by Icom Inc., could void your authority to operate this transceiver under FCC regulations.



Versions of the IC-F3/IC-F4 which display “CE” on the serial number seal, comply with the essential requirements of the 89/336/EEC directive for Electromagnetic Compatibility.

TABLE OF CONTENTS

IMPORTANT	i
CAUTIONS	i
TABLE OF CONTENTS	i
1 GETTING STARTED	1
2 PANEL DESCRIPTION	2
3 DEALER-PROGRAMMABLE FUNCTIONS	3-6
■ General	3
■ Functions	4
4 CONVENTIONAL OPERATION	7-8
5 SmarTrunk II™ OPERATION	9-10
6 OPTIONAL INSTALLATION.....	11
7 BATTERY PACKS	12-16
■ Battery pack replacement.....	12
■ Cautions	12
■ Charging.....	14
8 SPECIFICATIONS AND OPTIONS	17
■ Specifications	17
■ Options	17

SmarTrunk II™ is a trademark of SmarTrunk Systems, Inc.

◇ UNPACKING

The transceiver comes supplied with the following accessories*.

- ① Flexible antenna
- ② Belt clip
- ③ 1922A REAR-SHEET

*The BP-196 BATTERY PACK comes attached to the transceiver.

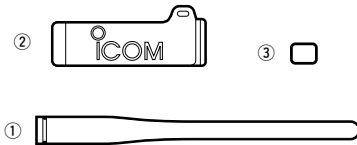

◇ ANTENNA

The antenna screws onto the transceiver as illustrated below.

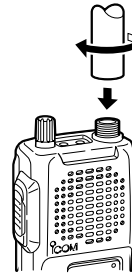

◇ TURNING POWER ON

Rotate the volume control to the 12 o'clock position.

- A power-up alert tone sounds for about 2 sec. and an opening message may appear.

(Above functions depend on pre-setting.)

Then a channel number appears on the display.

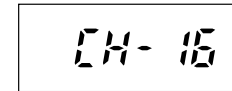

Channel number may differ from this.

NOTE: If the power-up alert tone does not sound or a channel number does not appear on the display, turn the transceiver OFF, check the battery, then turn the transceiver back ON.

If the power-up tone still does not sound or a channel number does not appear, charge the battery or replace it.

NOTE: To increment or decrement the displayed channel, push [▲] or [▼] keys.

◇ BELT CLIP

Attach the belt clip to the transceiver as illustrated below.

Attach the belt-clip

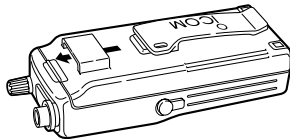

Release the belt-clip

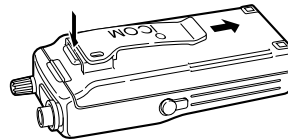

PANEL DESCRIPTION

IC-F3,IC-F4

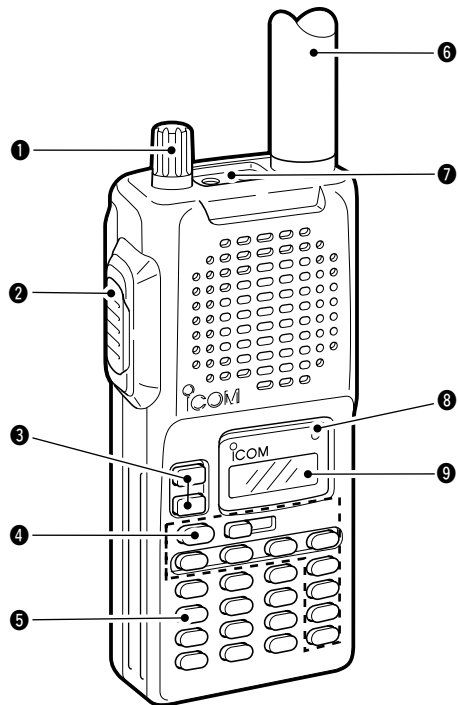

IC-F3S,IC-F4S

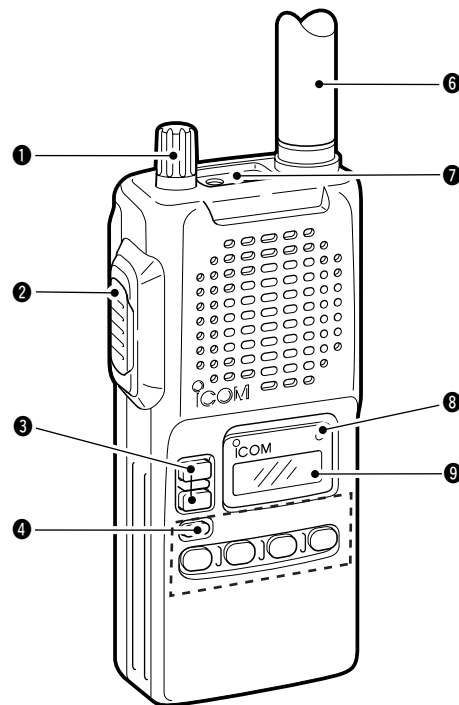

1 VOLUME CONTROL [OFF/VOL]

Turns power ON and adjusts the audio level.

2 PTT SWITCH [PTT]

Push and hold to transmit; release to receive.

3 UP/DOWN KEYS [▲]/[▼]

- Push to select the operating channel.
- Can be programmed as [*]/[#]. (SmarTrunk mode only)

4 DEALER-PROGRAMMABLE KEYS

[P0]/[P1]/[P2]/[P3]/[A]/[B]/[C]/[D]/ [◀]/[▶]/[←]/[→]

Can each be programmed for one of several functions by your Icom Dealer (see right).

5 KEYPAD

Used to enter DTMF codes, the operating channel, etc.

6 ANTENNA CONNECTOR

Connects the supplied antenna.

7 [SP]/[MIC] JACK

Connect optional speaker-microphone.

8 ACTIVITY LED

Lights red while transmitting.

9 FUNCTION DISPLAY

Displays the following the information:

- CH number.
- 5-tone indication.
- Low-battery indication.
- DTMF numbers.
- Low-power indication.
- Skip-ch indication.
- Audible indication.

NOTE: Above functions depend on presetting.

General

Consult your Icom Dealer or System operator for details concerning your transceiver's programming. When available, programmed functions are assigned to [P0], [P1], [P2], [P3], [A]*1, [B]*1, [C]*1, [D]*1, [◀]*1, [▶]*1, [←]*2 and [▲]/[▼]*3.

*1: IC-F3/IC-F4 only.

*2: IC-F3S/IC-F4S only.

*3: SmarTrunk II mode when assigned [*]/[#] functions only.

◆ Programmable key reference.

IC-F3/IC-F4

[▲]		[▶]	
[▼]		[◀]	
[P0]		[A]	
[P1]		[B]	
[P2]		[C]	
[P3]		[D]	

IC-F3S/IC-F4S

[▲]		[P0]	
[▼]		[P1]	
[−]		[P2]	
		[P3]	

3 DEALER-PROGRAMMABLE FUNCTIONS

■ Functions

In the following explanations, programmable function names are bracketed, the specific switch used to activate the function depends on programming.

◆ KEYPAD LOCK FUNCTION

This function locks access to all programmable switches (except the switch assigned the lock function).

To toggle the lock function ON and OFF:

Push and hold the [LOCK] switch for 1 sec.

- “” appears while the lock function is ON.
- This function may be inhibited on some channels.

◆ PRIORITY CHANNEL

This function is used to select a pre-programmed channel at the push of a switch.

To select the priority channel:

Push the [PRIORITY] switch.

- “PRIO” appears briefly, then the priority channel is automatically selected.

◆ SCAN FUNCTION

The scan function allows you to search a pre-programmed group of channels for signals.

To start/stop scan:

Push the [SCAN] switch.

- Scan pauses on a channel when receiving a signal.
- Depending on programming, a message may appear while scanning.
- “Lockout SCAN” (pre-programmed list SCAN) or “Priority SCAN” can be pre-programmed.
- When the “Power-save function” is activated, the transceiver checks all pre-programmed channels then returns to the “Power-save function” again.

◆ BEEP FUNCTION

This function provides confirmation beep tones when pushing switches.

To toggle the function ON and OFF:

Push the [BEEP] switch.

◆ MONITOR AUDIBLE FUNCTION

The monitor function allows you to open the transceiver's squelch manually to check whether a channel is busy or not. The transceiver has 2 conditions for receive standby:



All signals are received

Audible condition:

This condition mutes audio ONLY when no carrier is present. You can receive (or monitor) any signals on a channel.

- Push and hold the [MONI/AUDI], switch to select the audible condition. Any audio mute functions are cancelled while pushing the [MONI/AUDI] switch.

Inaudible condition:

This condition mutes ALL signals except those directed to you. Therefore you should check a channel's condition (busy or not) with the monitor function before transmitting.

- Push the [MONI/AUDI] switch momentarily to select the inaudible condition.



Only signals containing the proper tone are received

◆ TALK AROUND

The talk around function changes duplex channels to simplex channels.

- **Duplex** allows you to contact your base station, repeaters, etc.
- **Simplex** allows you to contact other portable transceivers directly (portable-to-portable contact).

To toggle the talk around function ON and OFF:

Push the [TALK AROUND] switch one or more times.

◆ DTMF TRANSMISSION

This function allows you to send a pre-programmed DTMF code to control a repeater, open another transceiver's squelch, etc.

Manual transmission:

Push desired digit keys in sequence while pushing [PTT].

- Pushing [PTT] may not be necessary depending on programming.

Automatic pre-programmed transmission:

- ① Push the [DTMF] switch to select DTMF autodial mode then push [▲] or [▼] to select the desired channel.
- ② Push the [DTMF] switch once more to send a DTMF code.

3 DEALER-PROGRAMMABLE FUNCTIONS

◆ DTMF RE-DIAL FUNCTION

This function allows you to transmit the last-used DTMF code at the push of a key.

To activate the function:

Push the [DTMF RE-DIAL] switch momentarily.

- The previously transmitted DTMF code is automatically transmitted.
- If no code has been transmitted since turning the power ON, this function does not activate.

◆ HIGH/LOW POWER OUTPUT

This function selects high or low power for a channel.

To toggle between high and low power:

Push the [HIGH/LOW] switch.

- “LOW” appears when low output power is selected.

◆ EMERGENCY FUNCTION

The emergency function allows you to send your ID quickly and easily to your Base Station, etc. in case of emergency.

To activate the emergency function:

Push and hold the [EMERGENCY] switch for 1 sec.

- The transceiver selects a pre-programmed channel, then sends an emergency signal to your Base Station.
- The pre-programmed channel remains selected until a control signal is received from the Base Station or power is turned OFF.

- The emergency call is repeatedly transmitted at pre-programmed intervals.

◆ DISPLAY LIGHTING

The function display has 3 backlight conditions.

OFF: No backlight is available.

AUTO: When any key is pushed, the backlight turns ON for 5 sec. automatically.

CONTINUOUS: Backlight turns ON continuously after power ON.

◆ SmarTrunk II™ functions

This transceiver provides SmarTrunk II™ functions.

(Optional UT-105 SmarTrunk II™ Logic Board is required.)

The optional UT-105 allows communication over conventional channels or SmarTrunk II™ channels. Select a channel bank for SmarTrunk II™ before trunking operation.

To toggle SmarTrunk II™ channels and conventional channels.

Push the [Bank Up] switch one or more times.

- Scanning starts when a channel bank for SmarTrunk II™ is selected.
- Contact your dealer for channel bank details.
(See p.9 for more detailed operation.)

■ Receiving and transmitting

NOTE: Transmitting without an antenna may damage the transceiver. See p.1 for antenna attachment.

Turn power ON as described on p.1.

Receiving:

- ① Push [▲]/[▼] to select a channel.
- ② Listen for a transmission and adjust [VOL] to a comfortable listening level.
 - When no transmission is heard, push and hold monitor while adjusting [VOL] (your transceiver may not be programmed with the monitor function).

The transceiver is now set to receive desired calls on the selected channel.

Transmitting:

Wait for the channel to become clear to avoid interference.

- ③ While pushing and holding [PTT], speak into the microphone at a normal voice level.
 - When a tone signalling system is used, the call procedure described at right may be necessary.
- ④ Release [PTT] to return to receive.

IMPORTANT: To maximize the readability of your transmitted signal, pause a few secs. after pushing [PTT], hold the microphone 10 to 15 cm from your mouth and speak at a normal voice level.

■ Call procedure

When your system employs tone signalling (excluding CTCSS and DTCS), the call procedure may be necessary prior to voice transmission. The tone signalling employed may be a selective calling system which allows you to call specific station(s) only and prevent unwanted stations from contacting you.

- ① Select the desired Tx code channel or 5-tone code according to your System Operator's instructions.
 - This may not be necessary depending on programming.
 - Refer to the next page for selection.
- ② Push the call switch (assigned to one of the dealer programmable switches: [P0], [P1], [P2], [P3], [A], [B], [C], [D], [◀], [▶] and [-]).
- ③ After transmitting a 5-TONE code, the remainder of your communication can be carried out in the normal fashion.

Selective calling

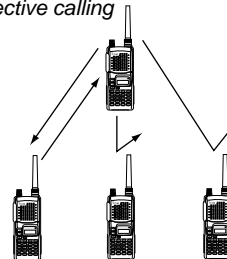

Non-selective calling

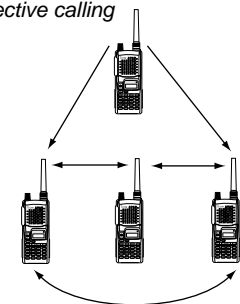

4 CONVENTIONAL OPERATION

■ Tx code channel selection

Your radio may be programmed for Tx code channel selection. In this case, you can choose a Tx code channel to be transmitted when using the call function (p.7).

Push the Tx code channel switch (assigned to one of the dealer-programmable switches) to activate the function, then enter digits via the keypad to select the desired Tx code channel.

- The selected code channel (containing a pre-programmed 5-tone code) is transmitted when using the call function.

■ Manual 5-tone codes

Depending on programming, you may be able to send 5-tone codes manually.

Push the Tx code switch to activate the function, then enter the desired transmit code (up to 7 digits) using the keypad.

- Activate the call function to transmit the 5-tone code.
- Blinking indicates keypad entry is acceptable.

■ Transmitting notes

◇ LOW BATTERY INDICATION

- When **+** appears, battery capacity is becoming low and transmitting is impossible.
- When **+** flashes, battery capacity is nearly exhausted.

◇ TIME-OUT TIMER

After continuous transmission for a pre-programmed period, the time-out timer is activated, causing the transceiver to stop transmitting and automatically select receive.

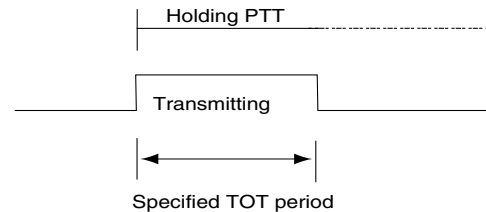

◇ PENALTY TIMER

Once the time-out timer is activated, transmission is further inhibited for a period determined by the penalty timer.

■ Basic operation

These features are enabled by your Dealer or System Operator and may not be available in your system. Contact your Dealer for details.

Push the [Bank Up] switch one or more times to select a channel bank for conventional channels or SmarTrunk II™ channels.

- Scanning starts when a channel bank for SmarTrunk II™ is selected.

◆ PTT dispatch operation *1

- ① Push [PTT] once (without dialing) to initiate a dispatch call.
- ② Begin talking after you hear three beeps (one short, high-pitched, two very-short, low-pitched).
- ③ Receiving a dispatch call is indicated by the same three-beep sequence.
 - It is not necessary to push [*] to answer a dispatch call.

◆ System busy indication

If all channels are busy, three low beeps sound after you initiate a call. Try the call again later.

◆ Receiving a subscriber-to-subscriber call *1

When you hear ringing, push [*] to answer.

- For a group call, you hear a short ring followed by two short beeps. You do not have to answer a group call to hear it over the air.

◆ Receiving a landline-to-subscriber call *1

When you hear ringing, push [*] to answer.

- For a group call, you hear a short ring followed by two short beeps. You do not have to answer a group call to hear it over the air.

◆ Terminating a call *1

After completing a call, push [#] to disconnect (hang up).

IMPORTANT: If one person in the conversation terminates a call, all participants will be cut off.

◆ Last number redial *1

Push [*], [*] to automatically redial the last number called.

- A high-pitched beep indicates that the number is accepted.

1: This function is available to for the IC-F3S/IC-F4S when the [▲]/[▼] keys are assigned the []/[#] key functions.

5 SmarTrunk II™ OPERATION

◇ Clear channel alerting *1

If all channels are busy, the transceiver automatically begins searching for an open channel and beeps every ten seconds. When two short beeps (low-pitched, then high-pitched) are heard, a channel is available. Push [*], [*] immediately to redial the last number.

◇ Turbo Speedial

To automatically dial a commonly used number with one push:

- Push one of the turbo Speedials :
IC-F3/IC-F4: [A], [B], [C] or [D]
IC-F3S/IC-F4S: [P0],[P1], [P2], [P3], or [-]

◇ Programming memory speed dial

- ① Push and hold [*] until you hear a high-pitched beep.
- ② Enter the memory location (0–9, A, B, C, D), the telephone or subscriber number, then [1], [*] (or [3], [*] if for another system subscriber).
 - A high-pitched beep indicates successful programming.
 - Memories [A]–[D] are used for the Turbo Speedial.

NOTE: This function is available for the IC-F3/IC-F4 only.

◇ Emergency call *2

Push [0], [*] to initiate an emergency call.

- Contact your Dealer for details.

◇ Memory speed-dialing *2

To automatically dial a commonly used number from memory:

- Push [*] followed by the memory location (0–9).

◇ Placing a telephone call *2

Enter the phone number followed by [1], [*].

- A high-pitched beep indicates that the number is accepted.
- When the called party answers, push the [PTT] switch to talk, and release it to listen.

◇ Calling another local system subscriber *2

Enter the subscriber number followed by [3], [*].

- A high-pitched beep indicates that the number is accepted.
- You hear ringing, then two short beeps when the subscriber answers.
- If the other subscriber is on another call or out of range, you hear a fast busy signal and the call terminates automatically.

*1: This function is available for the IC-F3S/IC-F4S when the [▲]/[▼] keys are assigned the [*]/[#] key functions.

*2: This function is available for the IC-F3/IC-F4 only.
Use the Turbo Speedial function instead.

For additional operating instructions, contact your Dealer or System Operator.

■ UT-80 2-TONE UNIT, UT-96 5-TONE UNIT or UT-105 SmarTrunk II™ Logic Board

Only one of the above optional units can be installed in the IC-F3/IC-F4.

- ① Remove the battery pack from the transceiver as shown in Fig. 1.
- ② Remove the service cover. (Fig. 2)
- ③ Take out the protective sponge. (Fig. 2)
 - This sponge is not used when options are installed.
- ④ Connect the optional unit as shown in Fig. 2.
- ⑤ Replace the service cover.

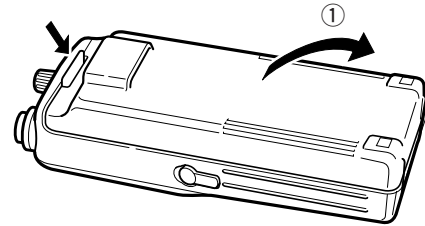

(Fig. 1)

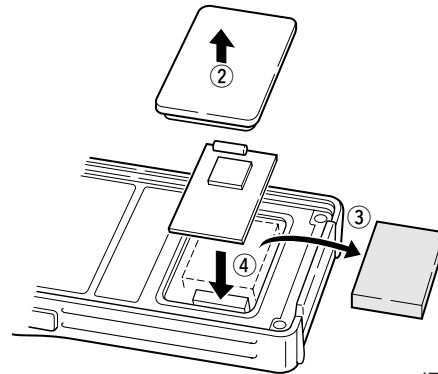

(Fig. 2)

■ Battery pack replacement

Before replacing the battery pack, the volume control **MUST** be rotated fully counterclockwise, until a click is heard, to turn the power OFF.

•**TO REMOVE** the battery pack from the transceiver:
Push and hold the battery release downwards, then pull the battery pack upwards with the transceiver facing you.

•**TO ATTACH** the battery pack to the transceiver:
Mate the notched ends of the battery pack and the transceiver, and push the battery pack until it clicks into place.

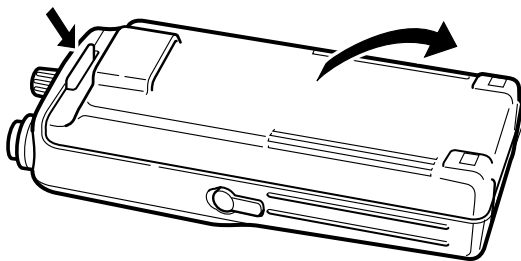

■ Battery cautions

NEVER incinerate used battery packs. Internal battery gas may cause an explosion.

NEVER immerse the battery pack in water. If the battery pack becomes wet, be sure to wipe it dry **BEFORE** attaching it to the transceiver.

NEVER short terminals of the battery pack. Also, current may flow into nearby metal objects so be careful when placing battery packs in handbags, etc.

If your battery pack seems to have no capacity even after being charged, completely discharge it by leaving the power ON overnight. Then, fully charge the battery pack again. If the battery pack still does not retain a charge (or very little), a new battery pack must be purchased.

◇ Recycling information (U.S.A. only)



The product that you have purchased contains a rechargeable battery. The battery is recyclable. At the end of its life, under various state and local laws, it may be illegal to dispose of this battery into the municipal waste stream. Call 1-800-8-BATTERY for battery recycling options in your area or contact your dealer.

■ Battery case

When using a BP-194 OPTIONAL BATTERY CASE attached to the transceiver, install 8 AA (R6) size alkaline or Ni-Cd batteries as illustrated below.

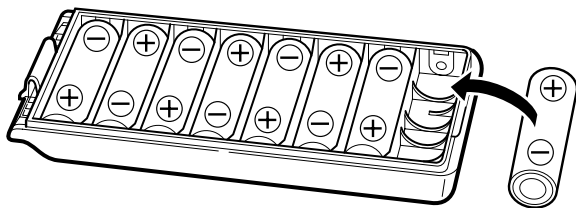

◇ Battery case cautions

When installing Ni-Cd batteries:

- **Make sure** all Ni-Cd cells are the same brand, type and capacity.
- **Never** mix old and new batteries.
Either of the above may cause a fire hazard or damage the transceiver.

When installing dry cell or alkaline batteries:

- **Never** connect DC power to the transceiver. Such a connection always charges the installed batteries and will damage the transceiver.

For both Ni-Cd and dry cell batteries:

- **Never** incinerate used battery cells since internal battery gas may cause them to rupture.
- **Never** expose a detached battery case to water.
If the battery case gets wet, be sure to wipe it dry before using.

7 BATTERY PACKS

■ Battery charging

Prior to using the transceiver for the first time, the battery pack must be fully charged for optimum life and operation.

CAUTION: To avoid damage to the transceiver, turn it OFF while charging.

- Recommended temperature range for charging: +10°C to +40°C (50°F to 140°F).
- Use the supplied charger or optional charger (BC-119/BC-121 for rapid charging) only. **NEVER** use other manufacturers' chargers.
- An optional cable OPC-254L (for 13.8 V power source) or CP-12L (for 12 V cigarette lighter socket) can be used instead of the AC adapters supplied with the above chargers.

When using the BC-119: If the charge indicator flashes orange, the vehicle battery voltage is low and charging may not be performed. Check the vehicle battery voltage in this case. If the charge indicator flashes red, there may be a problem with the battery pack (or charger). Re-insert the battery pack or contact your dealer.

◇ Rapid charging with the BC-119

The optional BC-119 provides rapid charging of optional Ni-Cd battery packs.

The following are additionally required:

- One AD-81.
- An AC adapter (may be supplied with the BC-119 depending on version).

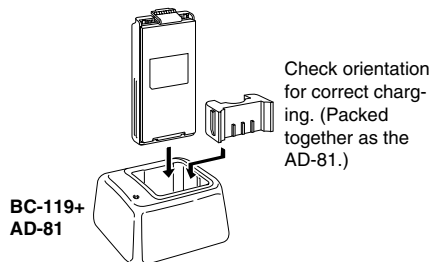
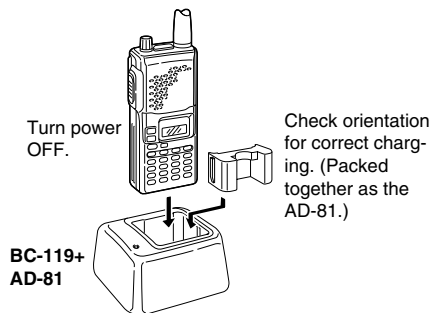

◇ Multiple charging with the BC-121

The optional BC-121 allows up to 6 Ni-Cd batteries to be charged simultaneously. The following are additionally required.

- Six AD-81s.
- An AC adapter (may be supplied with the BC-121 depending on version).

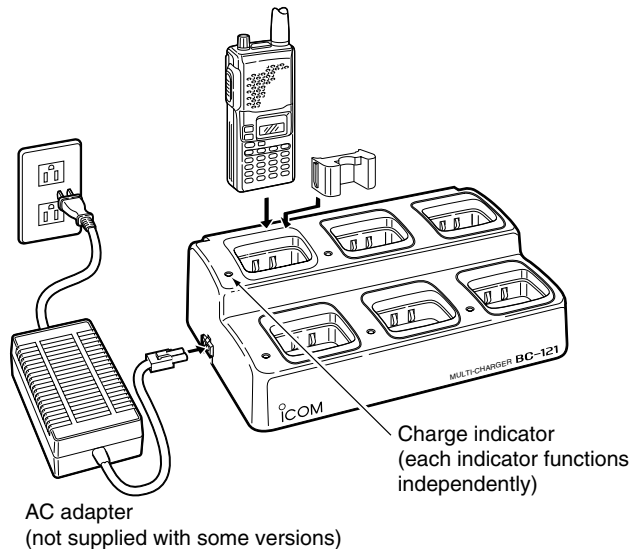

◇ Charging with the BC-110A/D/V

CAUTION: Only Ni-Cd batteries can be charged. NEVER connect a wall charger when dry cell or alkaline batteries are installed in the BP-194 OPTIONAL BATTERY CASE—the transceiver and/or battery case may be damaged.

Connect the optional BC-110A/D/V to the [CHARGE] jack on the transceiver.

- Approx. charging period: 15 hr.
- **DO NOT** turn power ON while connecting the BC-110A/D/V. Current capacity is insufficient.

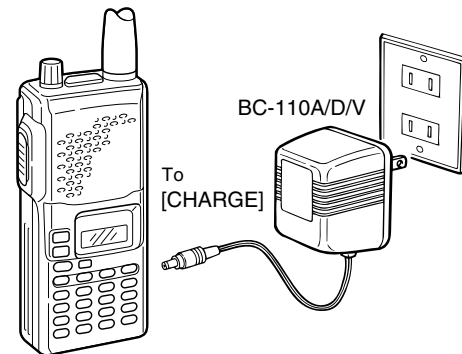

7 BATTERY PACKS

◇ Charging with an optional cables

The optional CP-12L CIGARETTE LIGHTER CABLE with noise filter or OPC-254L DC POWER CABLE with a 12 to 16 V DC power source can also be used to charge the battery packs (except the BP-194 with installed dry cell or alkaline batteries).

Connect an optional charger or cable to the transceiver as illustrated below. Be careful of battery overcharging as the connected battery is charged simultaneously.

CAUTION: Even if the power source has enough capacity, the [CHARGE] jack can be used for charging purposes only. You can not operate the transceiver without an internal power source.

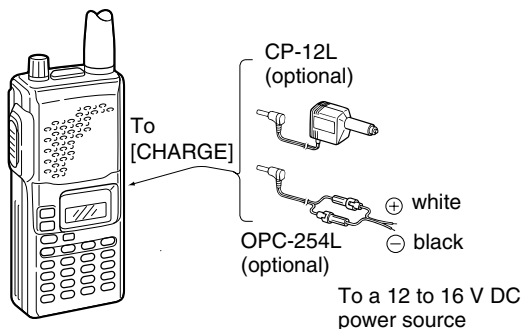

■ Optional battery pack

The optional BP-195 or BP-196 battery packs include rechargeable Ni-Cd batteries and can be charged approx. 300 times. Charge the battery pack before first operating the transceiver or when the battery pack becomes exhausted.

If you want to charge the battery pack more than 300 times, the following points should be observed:

1. Avoid over charging. The charging period should be less than 48 hours.
2. Use the battery until it becomes almost completely exhausted under normal conditions. We recommend battery charging after transmitting becomes impossible.

◇ Battery pack life

When the operating period becomes extremely short even after charging the battery pack fully, a new battery pack is needed.

Battery pack	Voltage/capacity	Charging period with BC-119
BP-195	9.6V/ 700mA	Approx. 1.5 hours
BP-196	9.6V/ 1050mA	Approx. 2.0 hours

■ Specifications

● GENERAL

Frequency coverage	: IC-F3/S	136–150 MHz 146–174 MHz
	: IC-F4/S	400–430 MHz 440–470 MHz 470–500 MHz 490–512 MHz 490–520 MHz
Mode	: 16K0F3E (wide) 8K50F3E (narrow)	
Usable temperature range		
EIA	: –22°F to +140°F	
ETS, CEPT	: –25°C to +55°C (IC-F3/S) –20°C to +55°C (IC-F4/S)	
Dimensions (projections not included)	: 58 (W)×138.5 (H)×37(D) mm	
Weight (with BP-196)	: 390 g	

● TRANSMITTER

Output power	: IC-F3/S	5 W
	: IC-F4/S	4 W

● RECEIVER

Sensitivity (12 dB SINAD)*	: IC-F3/S	0.25 μ V
(* Typical)	: IC-F4/S	0.3 μ V
Intermodulation rejection ratio	: More than 65 dB	
Spurious response rejection ratio	: More than 70 dB	
Adjacent channel selectivity	: More than 70 dB (wide) More than 60 dB (narrow)	
Audio output power	: 500 mW (at 10% distortion with an 8 Ω load)	

■ Options

● HM-54/HM-46/HM-75A SPEAKER-MICROPHONES

Combination speaker-microphone that provides convenient operation while hanging the transceiver from your belt clip.

● BC-119 DESKTOP CHARGER (or BC-121 MULTI-CHARGER) + AD-81 DESKTOP CHARGER ADAPTER

Used for rapid charging of battery packs. Charging time: 1.5 to 2 hours. An AC adapter is supplied with the chargers (depending on version). BC-121 rapidly charges up to 6 battery packs at once.

● BC-110A/D/V WALL CHARGER

Used for charging via a domestic AC wall socket.

● CP-12L CIGARETTE LIGHTER CABLE

Used for charging via a vehicle's cigarette lighter socket (12 V).

● OPC-254L DC POWER CABLE

Used for charging with an external power supply.

● UT-80 2-TONE UNIT

Provides 2-tone capabilities.

● UT-96 5-TONE UNIT

Provides 5-tone capabilities.

● UT-105 SmarTrunk II™ Logic Board

Provides SmarTrunk II™ operation.

● BP-194 BATTERY CASE

Takes eight (8) AA (R6) size batteries. External DC-jack on the transceiver can be used to charge the Ni-Cd battery cells.

● SP-13 EARPHONE

Provides clear audio in noisy environments.

All stated specifications are subject to change without notice or obligation.

Count on us!

A-5452H-1EX-②
Printed in Japan
Copyright 1997 by Icom Inc.

Icom Inc.
1-1-32 Kamiminami, Hirano-ku, Osaka 547-0003 Japan