

*Thanks for buying the  WOUXUN transceiver.*

*This transceiver offers latest design, multi-functionality, stable performance and easy operation. We believe you will be pleased with the high quality and dependable features for all your communication needs.*

## User Safety, Training, and General Information

READ THIS IMPORTANT INFORMATION ON SAFE AND EFFICIENT OPERATION BEFORE USING YOUR **Wouxun** PORTABLE TWO-WAY RADIO.

### Compliance with RF Energy Exposure Standards

Your **Wouxun** two-way radio is designed and tested to comply with a number of national and international standards and guidelines (listed below) regarding human exposure to radio frequency electromagnetic energy. This radio complies with the IEEE (FCC) and ICNIRP exposure limits for occupational/controlled RF exposure environment at duty cycles of up to 50% talk-50% listen and should be used for occupational use only. In terms of measuring RF energy for compliance with the FCC exposure guidelines, your radio radiates measurable RF energy only while it is transmitting (during talking), not when it is receiving (listening) or in standby mode.

#### **NOTE**

» The approved batteries supplied with this radio are rated for a 5-5-90 duty cycle (5% talk-5% listen-90% standby), even though this radio complies with the FCC occupational RF exposure limits at duty cycles of up to 50% talk.

Your **Wouxun** two-way radio Complies with the following of RF energy exposure standards and guidelines:

- United States Federal Communications Commission, Code of Federal Regulations; 47CFR part 2 sub-part J
- American National Standards Institute (ANSI)/Institute of Electrical and Electronic Engineers (IEEE) C95. 1-1992
- Institute of Electrical and Electronic Engineers (IEEE) C95. 1-1999 Edition
- International Commission on Non-Ionizing Radiation Protection (ICNIRP) 1998

### Operational Instructions and Training Guidelines

To ensure optimal performance and compliance with the occupational/controlled environment RF energy exposure limits in the above standards and guidelines, users should transmit no more than 50% of the time and always adhere to the following procedures:

#### **Transmit and Receive**



To transmit (talk), push the Push-To-Talk (PTT) button; to receive, release the PTT button.

#### **Hand-held radio operation**





Hold the radio in a vertical position with the microphone 5 cm away from the lips and let the antenna

farther away from your head.

### Body-worn operation

Always place the radio in an  approved clip, holder, holster, case, or body harness for this product. Use of non- -approved accessories may exceed FCC RF exposure guidelines.

### Antennas & Batteries

- Use only  approved, supplied antenna or  approved replacement antenna.
- Unauthorized antennas, modifications, or attachments could damage the radio and may violate FCC regulations.
- Use only  approved, supplied batteries or  approved replacement batteries.
- Use of non- -approved batteries may exceed FCC RF exposure guidelines.



### Approved Accessories

For a list of  approved accessories, see the accessories page of this user manual or visit the following website which lists approved accessories: <http://www.wouxun.com>

### Notices to the User

- Government law prohibits the operation of unlicensed radio transmitters within the territories under government control.
- Illegal operation is punishable by fine or imprisonment or both.
- Refer service to qualified technicians only.

**WARNING:** It is important that the operator is aware of and understand hazards common to the operation of any transceiver. Explosive environment (such as gases, dust, fumes, etc). Turn off your transceiver while talking on fuel, or while parked in gasoline service stations.

If you require this machine to be developed or some changed, please connect with  or your  dealer.

### FCC Caution:

This equipment has been tested and found to comply with the part 90 of the FCC Rules. These limits are designed to provide reasonable protection against harmful interference in a residential installation. This equipment generates, uses and can radiate radio frequency energy and, if not installed and used in accordance with the instructions, may cause harmful interference to radio communications. However, there is no guarantee that interference will not occur in a particular installation. If this equipment does

cause harmful interference to radio or television reception, which can be determined by turning the equipment off and on, the user is encouraged to try to correct the interference by one or more of the following

**Measures:**

- Reorient or relocate the receiving antenna.
- Increase the separation between the equipment and receiver.
- Connect the equipment into an outlet on a circuit different from that to which the receiver is connected.
- Consult the dealer or an experienced radio/TV technician for help.

**FCC Licensing Requirements**

Your radio must be properly licensed Federal Communications Commission prior to use. Your

 **Wouxun** Wireless dealer can assist you in meeting these requirements. Your dealer will program each radio with your authorized frequencies, signaling codes, etc., and will be there to meet your communications needs as your system expands.

**Precautions**

Only qualified technicians are allowed to maintain this product.

Do not use the radio or charge a battery in explosive areas such as coal gas, dust, steam, etc.

**Switch OFF the radio while refueling or parking at gas station.**

Do not modify or adjust this radio without permission.

Do not expose the radio to direct sunlight over a long time, nor place it close to heating source.

Do not place the radio in excessively dusty, humid areas, nor on unstable surfaces.

Safety: It is important that the operator is aware of and understands hazards common to the operation of any radio.

**CE Caution:**

Hereby,  **Wouxun** declares that this Two-way radio is in compliance with the essential requirements and other relevant provisions of Directive 1999/5/EC.

A copy of the DOC may be obtained through the following address.

Address: No.928 Nanhuan Road, Jiangnan High Technology Industrial Park, Quanzhou, Fujian 362000, China

## Contents

<b>Unpacking and checking the equipments</b> .....	<b>01</b>
<i>Supplied accessories</i> .....	<b>01</b>
<b>Description of Functions</b> .....	<b>02-03</b>
<b>Getting Started</b> .....	<b>04-08</b>
<i>LCD Display</i> .....	<b>04</b>
<i>Description of transceiver</i> .....	<b>05-08</b>
<b>Shortcut Operation Sheet</b> .....	<b>09-12</b>
<b>How to Operate</b> .....	<b>13-44</b>
<i>Menu Locked Function</i> .....	<b>13-14</b>
<i>Setting Frequency Step (STEP) ----- MENU 1</i> .....	<b>14</b>
<i>Setting Squelch Level (SQL-LE) ----- MENU 2</i> .....	<b>15</b>
<i>Setting Battery Save Mode (SAVE) ----- MENU 3</i> .....	<b>15</b>
<i>Selecting Transmit Power (TXP) ----- MENU 4</i> .....	<b>16</b>
<i>Setting Begin/End Transmitting Voice Prompt (ROGER) ----- MENU 5</i> .....	<b>16</b>
<i>Transmit Over Timer (TOT) ----- MENU 6</i> .....	<b>17</b>
<i>Setting VOX (VOX) ----- MENU7</i> .....	<b>17</b>
<i>Setting Wide or Narrow Bandwidth (WN) ----- MENU 8</i> .....	<b>18</b>
<i>Setting Voice Prompt (VOICE) ----- MENU 9</i> .....	<b>18</b>

<i>Setting Transmit Overtime Alarm (TOA) ----- MENU10</i> .....	<b>18-19</b>
<i>BEEP Prompting Function (BEEP) ----- MENU 11</i> .....	<b>19</b>
<i>Setting Power-on Message (PONMSG) ----- MENU 12</i> .....	<b>20</b>
<i>Busy Channel Locked (BCL) ----- MENU 13</i> .....	<b>20</b>
<i>Setting Keypad Locked (AUTOLK) ----- MENU 14</i> .....	<b>21</b>
<i>Setting Receiving CTCSS (R-CTCSS) ----- MENU 15</i> .....	<b>22</b>
<i>Setting Transmitting CTCSS (T-CTCSS) ----- MENU 16</i> .....	<b>22</b>
<i>Setting Receiving DCS (R-DCS) ----- MENU 17</i> .....	<b>23</b>
<i>Setting Transmitting DCS (T-DCS) ----- MENU 18</i> .....	<b>23</b>
<i>Setting Scan Mode (SC-REV) ----- MENU 19</i> .....	<b>24</b>
<i>Setting Scan / Lamp / SOS-CH / Radio Function on Side key 1 ----- MENU 20</i> .....	<b>24-27</b>
<i>Working Mode (CH-MDF) ----- MENU 21</i> .....	<b>27-28</b>
<i>Setting Auto-Backlight (ABR) ----- MENU 22</i> .....	<b>29</b>
<i>Setting Offset Frequency (OFF-SET) ----- MENU23</i> .....	<b>30-31</b>
<i>Setting Frequency Shift Direction (SFT-D) ----- MENU 24</i> .....	<b>31</b>
<i>Setting Stopwatch Timer (SECOND) ----- MENU 25</i> .....	<b>32</b>
<i>Channel Name Edit (CHNAME) ----- MENU 26</i> .....	<b>32-33</b>
<i>Setting Memory Channel (MEM-CH) ----- MENU 27</i> .....	<b>34-35</b>

## Contents

<b>Deleting Channel (DEL-CH) ----- MENU 28</b> .....	<b>35</b>
<b>Setting Reset (RESET) ----- MENU 29</b> .....	<b>36-37</b>
<b>CTCSS/DCS Frequency Scan ----- MENU 30</b> .....	<b>38</b>
<b>DTMF Encoding</b> .....	<b>39</b>
<b>Setting Priority Scan Function</b> .....	<b>41</b>
<b>Setting Reverse Frequency Function</b> .....	<b>41-42</b>
<b>Low Voltage Battery Voice prompt</b> .....	<b>42</b>
<b>Transmit Overtime Prompt</b> .....	<b>42</b>
<b>Adding Scanning Channel</b> .....	<b>42</b>
<b>Wire Clone Function</b> .....	<b>43</b>
<b>Working with Repeater</b> .....	<b>43-44</b>
<b>How to Use the Intelligent Charger</b> .....	<b>44</b>
<b>Trouble Shooting</b> .....	<b>45-46</b>
<b>Technology Parameter</b> .....	<b>47-49</b>
Appendix 1 (CTCSS) .....	<b>47</b>
Appendix 2 (DCS) .....	<b>48-49</b>
<b>Technology Specification</b> .....	<b>50</b>
<b>Optional Accessories</b> .....	<b>51</b>
<b>Announcement</b> .....	<b>52</b>

## Unpacking and checking of your equipment

**wouxun**  
Professional FM Transceiver

Carefully unpack the transceiver. We recommend that you identify the items in the following table before discarding the packing material. If any items are missing or have been damaged during shipment, please notify your **wouxun** dealer.

### Supplied accessories

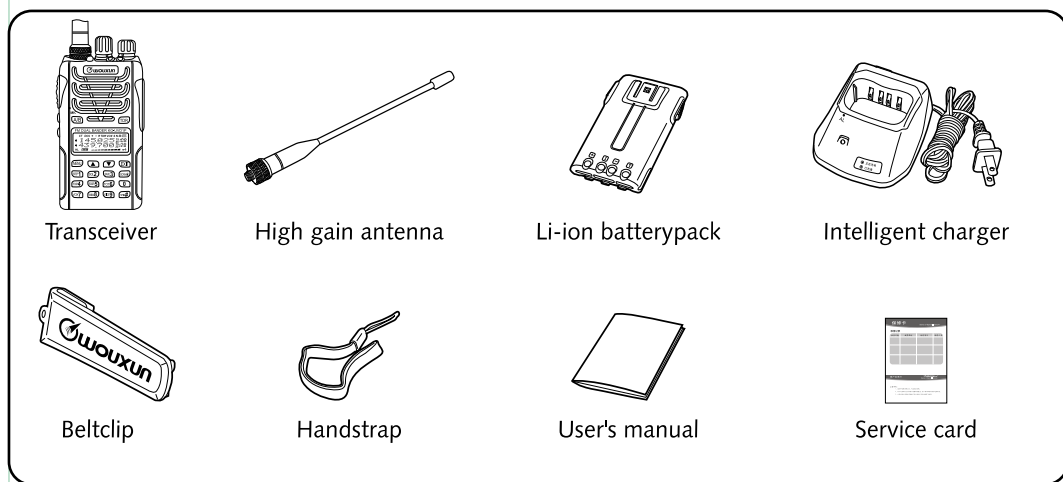

## Description of functions

1. Dual Band, Dual Frequency, Dual Display and Dual Standby
  2. Frequency Range (can be suitable for different countries or areas):  
136-174MHz & 350-470MHz (Rx / Tx),      136-174MHz & 400-480MHz (Rx / Tx),  
136-174MHz & 420-520MHz (Rx / Tx),      136-174MHz & 400-470MHz (Rx / Tx),  
136-174MHz & 245-250MHz (Rx / Tx),      136-174MHz & 216-280MHz (Rx / Tx),  
136-174MHz & 225-226MHz (Rx / Tx),      136-174MHz & 430-440MHz (Rx / Tx).
  3. Working Mode: U-V, V-V or U-U available
  4. Same Channel: VHF T x & UHF Rx or UHF T x & VHF Rx available
  5. DTMF Encoding
  6. Digital FM Radio (76-108MHz)
  7. CTCSS/DCS Frequency Scan
  8. Output Power: 5W VHF /4W UHF
  9. Memory Channel: 128 channels
  10. VOX Function
  11. Stopwatch Function
  12. 105 groups DCS and 50 groups CTCSS
  13. Voice Prompt
  14. SOS Function
  15. Wide/Narrow Bandwidth Selection (25KHz / 12.5KHz)
  16. Channel number, Channel + Frequency or Channel name display mode available
- 02

17. Reverse Frequency
18. Multi-functional Scan
19. Priority Scan Function
20. Bright Flashlight Illumination
21. Step (5/6.25/10/12.5/25KHz/50KHz/100KHz)
22. High/Low Power selection (5W/1W)
23. High Capacity Li-ion Battery
24. Intelligent Charger
25. Offset Frequency setting (0-69.950MHz)
26. Frequency Shift Direction Setting
27. Busy Channel Lockout
28. Power on Display (Battery-V/Full Screen/Other Characters)
29. Low-battery Voice Prompt
30. Start and/or End Transmitting Beep Prompt
31. Transmit Overtime Prompt
32. Keypad Locked (Auto / Manual)
33. Add Scanning Channel Function
34. High/Low power switchable when transmitting
35. Computer Programmable
36. Wire-clone Function
37. Menu/Channel Reset

## Getting Started

### LCD display

On the display you will see various indicators that show what function you have selected. Sometimes you may not recall what those indicators mean, or how to select them, in such a case, you can refer to the table below.

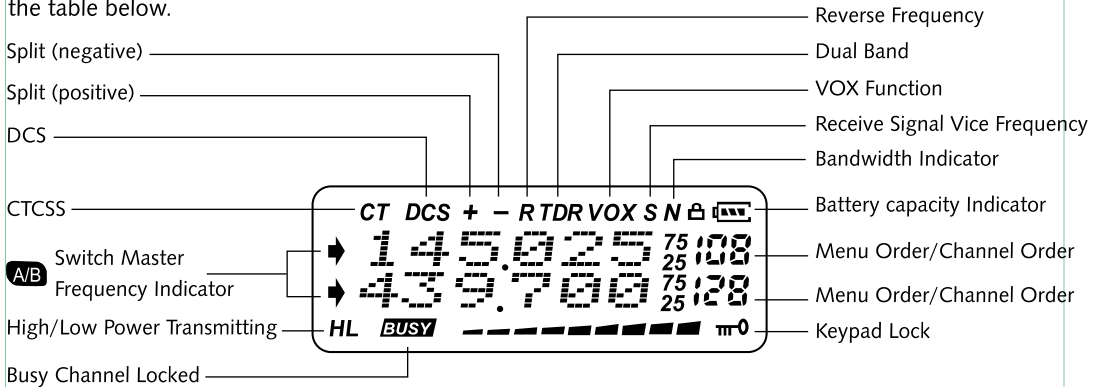

### Note:

- Battery pack power indicator (full)
- Battery pack power indicator (exhausted)
- Battery pack power indicator (remaining)
- Receive signal meter

### Description of transceiver

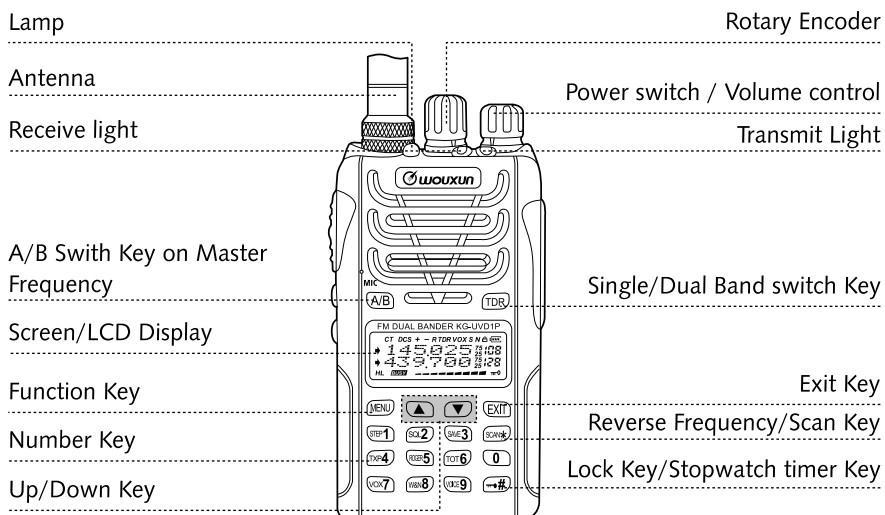

- Note:** Speedy switch on work mode ( **MENU** + **TDR** )  
Speedy re-start the transceiver ( **MENU** + **A/B** )



## Getting Started

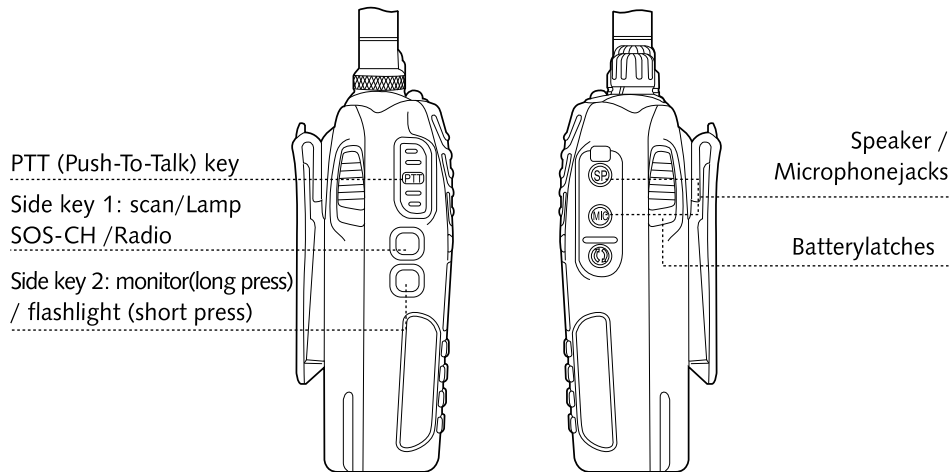

06

### ■ **Speed Search**

Press **▲** or **▼** key to set each Function or Parameter, it can search quickly.

### ■ **Single/Dual Band Switch**

Press **TDR**

Single Band  $\leftarrow$  .....  $\rightarrow$  Dual Band

### ■ **Speedy Re-start Transceiver**

In standby, press **MENU** + **A/B**, then LCD displays **STEP**. Press **MENU** to confirm, and then the transceiver re-starts.

### ■ **A/B Switch**

Press **A/B** to select the master frequency. The frequency displaying arrowhead is master frequency; the frequency without displaying arrowhead is vice frequency. The master frequency can be used for transmitting and receiving, and the vice frequency is only for receiving. When vice frequency receives, the screen displays " S ".

### ■ **Scan key**

Press slightly to set Reverse Frequency ON/OFF while press 2 seconds to active scan.

07

## Getting Started

### ■ Side key 2

Press slightly to turn ON/OFF the lamp while press 2 seconds to set Squelch ON.

### ■ 1750Hz Burst Tone

Sometimes, 1750Hz Burst tone is required to carry out some other specific functions. This transceiver has 1750Hz Burst tone to help you.

#### How to use

In transmitting, press side key PF1, the transceiver transmit 1750Hz Burst tone. The time pressing side key PF1 determined how long will transmit 1750Hz Burst tone. Release side key PF1 to end transmitting 1750Hz Burst tone.

## Shortcut operation sheet

Function order	Function name	Enter function set	Screen display	Select parameter	Selectable parameter explanation	Confirm	Return to standby	See page
1	Setting frequency step	MENU → STEP1	+STEP 12.50K	MENU → Press ▲/▼ key Select parameter	7 kinds of frequency steps 5K/6.25K/10K/12.5K/25K /50K/100K	→ MENU →	EXIT	P14
2	Setting squelch level	MENU → SQ2	+SQL-LEVEL 2	MENU → Press ▲/▼ key Select parameter	Squelch level from 0 to 9	→ MENU →	EXIT	P15
3	Setting batterypack savemode	MENU → SAVE3	+SAVE ON	MENU → Press ▲/▼ key Select parameter	ON: Turn on save function OFF: Turn off save function	→ MENU →	EXIT	P15
4	Selecting transmit power	MENU → TXP4	+TXP HIGH	MENU → Press ▲/▼ key Select parameter	H: High power (VHF 5W/UHF 4W) L: Low power (1W)	→ MENU →	EXIT	P16
5	Transmit voice prompt	MENU → ROGER5	+ROGER OFF	MENU → Press ▲/▼ key Select parameter	OFF: turn off this function, without any voice prompting. BOT: press PTT, voice prompt when begin transmitting EOT: release PTT, voice prompt when end transmitting BOTH: press and release PTT, voice prompt	→ MENU →	EXIT	P16
6	Transmit overtimer	MENU → TOT6	+TOT 60	MENU → Press ▲/▼ key Select parameter	TOT has 40 levels in steps of 15 seconds. OFF: Turn off TOT	→ MENU →	EXIT	P17
7	Setting VOX	MENU → VOX7	+VOX OFF	MENU → Press ▲/▼ key Select parameter	VOX has levels from 1 to 10 OFF: Turn off VOX transmission	→ MENU →	EXIT	P17
8	Setting bandwidth	MENU → WBN8	+WN WIDE	MENU → Press ▲/▼ key Select parameter	WIDE: 25KHz NARR: 12.5KHz	→ MENU →	EXIT	P18
9	Voice Prompt	MENU → VOICE9	+VOICE ENGLISH	MENU → Press ▲/▼ key Select parameter	CHINES: Chinese voice prompt ENGLISH: English voice prompt OFF: Turn off voice prompt	→ MENU →	EXIT	P18

## Shortcut operation sheet

10 Transmit overtime alarm	MENU → STEP1 → 0 →	• TOR S	MENU →	Press ▲ or ▼ key Select parameter	1 to 10 levels with 1 second each OFF: turn off TOA	MENU → EXIT	P18 -19
11 Setting Beep prompt	MENU → STEP1 → STEP1 →	• BEEP ON	MENU →	Press ▲ or ▼ key Select parameter	ON: Turn on Beep prompt function OFF: Turn off beep prompt function	MENU → EXIT	P19
12 Power on display	MENU → STEP1 → SOL2 →	• PDMMSG OFF	MENU →	Press ▲ or ▼ key Select parameter	OFF: Full screen display BATT: Battery voltage display MSG: WELCOME	MENU → EXIT	P20
13 Busy Channel Lockout	MENU → STEP1 → SAVE3 →	• BCL OFF	MENU →	Press ▲ or ▼ key Select parameter	ON: Turn on BCL OFF: Turn off BCL	MENU → EXIT	P20
14 Keypad Lock	MENU → STEP1 → TXP4 →	• AUTOLK OFF	MENU →	Press ▲ or ▼ key Select parameter	ON: Turn on Autolock OFF: Turn off Autolock	MENU → EXIT	P21
15 Receiving CTCSS	MENU → STEP1 → RCR5 →	• R-CTC OFF	MENU →	Press ▲ or ▼ key Select parameter	50 groups CTCSS (67.0Hz -254.1Hz) OFF: Turn off CTCSS	MENU → EXIT	P22
16 Transmitting CTCSS	MENU → STEP1 → TOT6 →	• T-CTC OFF	MENU →	Press ▲ or ▼ key Select parameter	50 groups CTCSS (67.0Hz -254.1Hz) OFF: Turn off CTCSS	MENU → EXIT	P22
17 Receiving DCS	MENU → STEP1 → VOX7 →	• R-DCS OFF	MENU →	Press ▲ or ▼ key Select parameter	105 groups DCS (D023N-D754N) OFF: Turn off DCS	MENU → EXIT	P23
18 Transmitting DCS	MENU → STEP1 → WAX8 →	• T-DCS OFF	MENU →	Press ▲ or ▼ key Select parameter	105 groups DCS (D023N-D754N) OFF: Turn off DCS	MENU → EXIT	P23
19 Scan mode	MENU → STEP1 → VOICE9 →	• SC-REV TO	MENU →	Press ▲ or ▼ key Select parameter	3 kinds of Scan modes TO: Time scanning mode CO: Carrier mode 1 scan SE: Carrier mode 2 scan	MENU → EXIT	P24

10

							
20 Scan/Lamp SOS-CH/Radio/(Side key 1)	MENU → SOL2 → 0 →	• PF1 RADIO	MENU →	Press ▲ or ▼ key Select parameter	SCAN: Activate scan LAMP: Turn on Lamp SOS-CH: SOS function RADIO: Turn on FM radio OFF: Inactivate	MENU → EXIT	P24 -27
21 Working mode	MENU → SOL2 → STEP1 →	• CH-MDF FREQ	MENU →	Press ▲ or ▼ key Select parameter	This transceiver has two working modes available: 1. Frequency mode (FREQ) 2. Channel mode Three kinds of channel mode available: ① Channel (CH) ② Frequency + Channel number (CH FREQ) ③ Channel name (NAME)	MENU → EXIT	P27 -28
22 Auto backlight	MENU → SOL2 → SOL2 →	• ABR ON	MENU →	Press ▲ or ▼ key Select parameter	ON: Turn on backlight OFF: Turn off backlight	MENU → EXIT	P29
23 Offset Frequency	MENU → SOL2 → SAVE3 →	• OFFSET 000000	MENU →	Press ▲ or ▼ key Select parameter	0-69.950MHz available	MENU → EXIT	P30 -31
24 Frequency shift Direction	MENU → SOL2 → TXP4 →	• SFT OFF	MENU →	Press ▲ or ▼ key Select parameter	+ Positive direction - Negative direction OFF: Turn off frequency shift direction	MENU → EXIT	P31
25 Stopwatch	MENU → SOL2 → RUB5 →	• SECOND OFF	MENU →	Press ▲ or ▼ key Select parameter	ON: Turn on Stopwatch function OFF: Turn off Stopwatch function	MENU → EXIT	P32
26 Edit Channel name	MENU → SOL2 → TOT6 →	• CHNAME -	MENU →	Press ▲ or ▼ key Select parameter	Channel name should be with in 26 letters (A to Z) and 10 numbers (0 to 9), six maximum	MENU → EXIT	P32 -33
27 Memory Channels	MENU → SOL2 → VOX7 →	• MEM-CH CH-001	MENU →	Press ▲ or ▼ key Select parameter	128 channels available	MENU → EXIT	P34 -35
28 Dlete channel	MENU → SOL2 → WAX8 →	• DEL-CH CH-001	MENU →	Press ▲ or ▼ key Select parameter	128 channels available	MENU → EXIT	P35

11

## Shortcut operation sheet

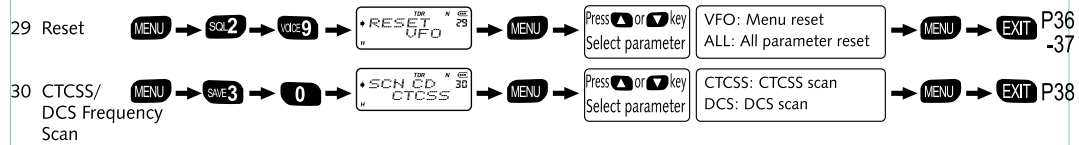

- Speed Search ▲ / ▼ (See page 07 )
- High/Low power can be changeable when transmitting (See page 16)
- SOS-CH (SOS function) (See page 25)
- DTMF encoding (See page 39 )
- Priority scan function (See page 41 )
- Set Reverse Frequency **SCAN\*** (See page 41-42 )
- Low-battery voice prompt (See page 42 )
- Transmit overtime prompt (See page 42 )
- Adding scanning channel function (See page 42)
- Wire clone function (See page 43 )
- Working with repeater (See page 43-44 )

12

## How to operate

**wouxun**  
Professional FM Transceiver

### Menu Locked function

To avoid operating menu often, you can set Menu Locked function on through the programming software, see the following operation steps:

1. Setting password of switching Channel and frequency mode.
2. Set the working mode as Channel mode
3. Turn off operating menu under channel mode.

When you want to operate Menu functions, input the password you set, then switch to frequency mode.

### NOTE

- » When the transceiver is on dual standby (TDR appears), the frequency that is displayed by the arrowhead is master frequency, the other one is vice frequency. When vice frequency receives, the LCD displays " S ". In dual standby, the master frequency is used for transmission; the vice frequency only can be used for receiving.
- » Master Frequency Setting  
In dual standby, press **A/B** to select the master frequency.
- » This transceiver with dual frequency and dual displaying function, it can display two different RX and TX frequencies at the same time under Frequency mode, while display two different channel frequencies and relative parameters at the same time under Channel mode.

13

## How to operate

### NOTE

» Under Frequency/Channel mode, Band A and B switchable through **A/B** key, if shows A, all the operating of channel or frequency is on band A, while shows B operating on band B.

**Under Frequency mode:** the following Nine functions can be set respectively on both Band A and Band B-

» frequency step, output power, squelch level, channel bandwidth, CTCSS, DCS, Frequency shift direction, Offset frequency, and Channel displaying mode.

» **Under Channel mode:** setting following seven functions on both Band A and B is invalid-Stepping transmit output power, CTCSS, DCS, channel bandwidth, frequency step, frequency shift direction and Offset frequency.

### Setting Frequency Step (STEP) ----- MENU 1

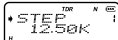
In standby, press **MENU** + **STEP1**, the screen displays 

Press **MENU** to enter, it shows '12.50K', press **▲** / **▼** to select the desired step, then press **MENU** to confirm, press **EXIT** return to standby.

This transceiver has seven frequency steps available: 5.00KHz, 10.00KHz, 12.50KHz, 25.00KHz, 50.00KHz and 100KHz.

### Setting Squelch Level (SQL-LE) ----- MENU 2

This function means turn on the squelch when the signal is strong while turn off the squelch when the signal is weak. Set the same codes and turn on the squelch, the device will 'sounds'. Setting the level too high may not receive the weak signals, while setting too low may receive the noise or other no desired signal.

### NOTE

» This transceiver has ten (0~9) levels available, and 0 means turn on the squelch, from 1 to 9 levels shows different levels of noise reduction. Higher level, louder squelch. The intensity of receiving signal is accordingly higher.

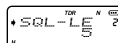
In standby, press **MENU** + **SQL2**, the screen displays 

Press **MENU** to enter, it shows '5', press **▲** / **▼** to select the desired squelch level, then press **MENU** to confirm, press **EXIT** return to standby.

### Setting Battery Save Mode (SAVE) --- MENU 3

To save battery, this function can turn off the receiver a certain time then turn on to check the signal.

In standby, press **MENU** + **SAVE3**, the screen displays 

Press **MENU** to enter, it shows 'ON', press **▲** / **▼** to select turn ON/OFF the battery save mode. press **MENU** to confirm, then press **EXIT** return to standby.

## How to operate

### Selecting Transmit Power (TXP) --- MENU 4

In Frequency mode, press **MENU** + **TXP4**, the screen displays 

Press **MENU** to enter, it shows 'HIGH', press **▲** / **▼** to select HIGH/LOW power, then press **MENU** to confirm, press **EXIT** return to standby.

This transceiver has 5W and 1W output power selectable. Transmitting output power can switch high/low temporarily. In transmission, press **TDR** key can switch the output power (switch between high and low power). Before powering off, the output power is the switched one. It will resume the previous power after powering on again.

### Setting Begin/End Transmitting Voice Prompt (ROGER) --- MENU 5

This function means to select transmitting voice prompt way:

**OFF:** turn off this function, without any voice prompting.

**BOT:** press PTT, voice prompt when begin transmitting

**EOT:** release PTT, voice prompt when end transmitting

**BOTH:** press and release PTT, voice prompt

In standby, press **MENU** + **ROGER5**, the screen displays 

Press **MENU** to enter, it shows 'OFF', press **▲** / **▼** to select OFF/BOT/EOT/BOTH, then press **MENU** to confirm, press **EXIT** return to standby.

16

### Transmit Over Timer (TOT) --- MENU 6

TOT is designed to prevent transmitting the transceivers too long. When operating exceed the preset time, it will stop transmitting and a warning sound can be heard.

This transceiver can be set in 40 levels with 15 seconds each, between 15 and 600 seconds.

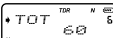
In standby, press **MENU** + **TOT6**, the screen displays 

Press **MENU** to enter, it shows '60', press **▲** / **▼** to select the desired transmitting level, then press **MENU** to confirm, press **EXIT** return to standby.

### Setting VOX (VOX) --- MENU 7

When the voice shows, the transceiver will switch to transmit mode automatically.

As the VOX should check the voice, transmitting will be a little delaying, and the beginning voice may not be transmitted.

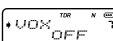
In standby, press **MENU** + **VOX7**, the screen displays 

Press **MENU** to enter, it shows 'OFF', press **▲** / **▼** to turn OFF VOX function or select VOX level (1~10), then press **MENU** to confirm, press **EXIT** return to standby.

#### **NOTE**

>> The higher VOX level the higher volume required.

## How to operate

### Setting Wide or Narrow Bandwidth (WN) --- MENU 8

In standby, press **MENU** + **WN8**, the screen displays

Press **MENU** to enter, it shows 'WIDE', press **▲** / **▼** to select WIDE/NARROW bandwidth, then press **MENU** to confirm, press **EXIT** return to standby.

### Setting Voice Prompt (VOICE) --- MENU 9

In standby, press **MENU** + **VOICE9**, the screen displays

Press **MENU** to enter, press **▲** / **▼** to select Chinese, English or OFF voice prompt, press **MENU** key to confirm, press **EXIT** return to standby.

#### **NOTE**

» If you want to turn off all prompt of keyboard, must turn off MENU 9 and MENU 11 at the same time.

### Setting Transmit Overtime Alarm (TOA) --- MENU 10

Turn on TOA function, when your transmission reached the preset TOT (transmit over time), the transceiver will alarm and TX indicator flash.

This transceiver can be set from 1 to 10 TOA level with 1 second each. 1 level means the transceiver prompt 1 second before transmitting reached to TOT.

18

In standby, press **MENU** + **STEP1 0**, the screen displays

Press **MENU** to enter, it shows '5', press **▲** / **▼** to select OFF/1~10 Level, then press **MENU** to confirm, press **EXIT** return to standby.

### Beep Prompting Function (BEEP) --- MENU 11

Beep prompting function is prompting the confirmed operation, wrong operation or malfunction.

We kindly suggest you to turn on this function to avoid any possible malfunction.

In standby, press **MENU** + **STEP1 STEP1**, the screen displays

Press **MENU** to enter, it shows 'ON', press **▲** / **▼** to select turn ON/OFF the beep prompting function, then press **MENU** to confirm, press **EXIT** return to standby.

#### **NOTE**

» If MENU (9) – Voice prompt function turn on, it will be priority.

## How to operate

### Setting Power-on Message (PONMSG) --- MENU 12

The power on message of this transceiver as following:

**OFF:** Full display

**BATT-V:** display the current battery voltage

**MSG:** display 'WELCOME'

In standby, press **MENU** + **STEP1** **SOL2**, the screen displays 

Press **MENU** to enter, it shows 'OFF', press **▲** / **▼** to select OFF/BATT-V/MSG, then press **MENU** to confirm, press **EXIT** return to standby.

### Busy Channel Locked (BCL) --- MENU 13

This function is to prevent the interference of other communicating channels. If the selected channel was occupied, press [PTT], the transceiver can not transmit.

In frequency mode, press **MENU** + **STEP1** **SWE3**, the screen displays 

Press **MENU** to enter, it shows 'OFF', press **▲** / **▼** to select ON/OFF this function, then press **MENU** to confirm, press **EXIT** return to standby.

20

### Setting Keypad Locked (AUTOLK) --- MENU 14

This transceiver has Auto-lock and Manual-lock available.

**ON:** Turn on keypad locked function, it will locked automatically if without any operation within 15 seconds. Press **↔#** more than 2 seconds to unlock the keypad.

**OFF:** Turn off auto-locked function.

#### **NOTE**

» Manually lock: in standby press **↔#** more than 2 seconds to lock keypad while press **↔#** more than 2 seconds again to unlock.

In standby, press **MENU** + **STEP1** **TXP4**, the screen displays 

Press **MENU** to enter, it shows 'OFF', press **▲** / **▼** to select ON/OFF this function, then press **MENU** to confirm, press **EXIT** return to standby.

21



## How to operate

### Setting Receiving CTCSS (R-CTCSS) --- MENU 15

Setting CTCSS/DCS can ignore the unwanted signals from other members working with the same frequency. Only with the same CTCSS/DCS codes can communicate.

In Frequency mode, press **MENU** + **STEP1** **ROZ5**, the screen displays

Press **MENU** to enter, it shows 'OFF', press **▲** / **▼** to turn OFF this function or select 67.0Hz to 254.1Hz CTCSS code, then press **MENU** to confirm, press **EXIT** return to standby.

#### NOTE

» This transceiver has 50 groups CTCSS, see appendix (1) CTCSS frequency sheet.

### Setting Transmitting CTCSS (T-CTCSS) --- MENU 16

In standby, press **MENU** + **STEP1** **TOT6**, the screen displays

Press **MENU** to enter, it shows 'OFF', press **▲** / **▼** to turn OFF this function or select 67.0Hz to 254.1Hz CTCSS code, then press **MENU** to confirm, press **EXIT** return to standby.

#### NOTE

» This transceiver has 50 groups CTCSS, see appendix (1) CTCSS frequency sheet.

22

### Setting Receiving DCS (R-DCS) --- MENU 17

In Frequency mode, press **MENU** + **STEP1** **VOX7**, the screen displays

Press **MENU** to enter, it shows 'OFF', press **▲** / **▼** to turn OFF this function or select D023N to D754I DCS code, then press **MENU** to confirm, press **EXIT** return to standby.

#### NOTE

» This transceiver has 105 groups DCS, see appendix (2) DCS frequency sheet. In it DXXXN (between D023N to D754N) means Positive code while DXXXI (between D023I and D754I) means Negative code.

### Setting Transmitting DCS (T-DCS) --- MENU 18

In Standby mode, press **MENU** + **STEP1** **WAX8**, the screen displays

Press **MENU** to enter, it shows 'OFF', press **▲** / **▼** to turn OFF this function or select D023N to D754I DCS code, then press **MENU** to confirm, press **EXIT** return to standby.

#### NOTE

» This transceiver has 105 groups DCS, see appendix (2) DCS frequency sheet. In it DXXXN (between D023N to D754N) means Positive code while DXXXI (between D023I and D754I) means Negative code.

23

## How to operate

### Setting Scan Mode (SC-REV) --- MENU 19

This transceiver has three scan modes:

**TO:** When receiving signals, it will go on scanning without any operation within 5 seconds.

**CO:** It will stop scanning when receiving signals, while go on scanning after signal disappeared 3 seconds.

**SE:** When receiving signals it will stop scanning.

In Standby mode, press **MENU** + **STEP1** **VOIC9**, the screen displays 

Press **MENU** to enter, it shows 'TO', press **▲** / **▼** to select TO/CO/SE scan mode, then press **MENU** to confirm, press **EXIT** return to standby.

### Setting Scan / Lamp / SOS-CH / Radio Function on Side key 1 (PF1) --- MENU 20

There are four functions available on the side key 1 of this transceiver:

**SCAN:** Scan function

**LAMP:** Lamp function

**SOS-CH:** SOS function

**RADIO:** FM radio function

**OFF:** Turn off functions

#### 1. Scan function:

In standby mode, press Side key 1 enter to Scan mode (scan mode can be set through MENU 19 -Scan Mode Setting), press any key to stop scanning.

24

In Standby mode, press **MENU** + **SQ2** **0**, the screen displays 

Press **MENU** to enter, press **▲** / **▼** to select SCAN, then press **MENU** to confirm, press **EXIT** return to standby.

#### 2. LAMP function:

In standby mode, press Side key 1 to turn on the Lamp, press again to turn off.

In Standby mode, press **MENU** + **SQ2** **0**, the screen displays 

Press **MENU** to enter, press **▲** / **▼** to select LAMP, then press **MENU** to confirm, press **EXIT** return to standby.

#### 3. SOS-CH (SOS function):

In emergency, it can transmit the "wu...wu..." SOS signals to the outside through the appointed Channel or Frequency in Band A or Band B, meanwhile, the transceiver will sound "wu...wu..." and the light flashes. It will transmit signals every 5 minutes, lasting for 10 seconds each time.

When transmitting SOS signal, press any key to exit.

On the interval of transmitting, if carrier signal appears, it starts receiving, after the carrier signal disappears, the transceiver will go on transmitting SOS-CH (SOS function). Press any key to exit.

25

## How to operate

### NOTE

- » In case that SOS-CH frequency you set is not the master frequency. When enters SOS alarm function, the transceiver automatically set SOS-CH on the master frequency, and will not resume.
- » Please press **A/B** key to reset the master frequency.

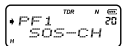
In standby, press **MENU** + **SQ2** **0**, then screen displays , then press **MENU** to enter, press **▲** / **▼** to choose SOS-CH submenu, the screen displays , press **MENU** again to confirm, press **▲** / **▼** to choose Band A or Band B, then press **MENU** to confirm, the transceiver sounds "wu...wu...", meanwhile the RED/GREEN/FLASHLIGHT flashing, it means set SOS-CH function ON.

Through the above setting, in standby, press PF1 side key, to transmit SOS signal.

#### 4. RADIO function:

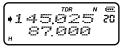
- **Turn on the Radio:** In standby mode, press Side key 1 to turn on. The screen displays , it will search the radio stations automatically when the green light flashing, and will stop until searched. You can listen the radio.
- **Tune the radio stations:** In Radio mode, press **SCAN\***, the radio will tune the stations automatically and the green light flashing at the same time, it will stop tuning while searched the station. You can also press **▲** / **▼** to turn the radio stations.

26

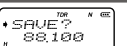
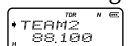
- **Store the radio stations:** When searching the station, press **MENU**, the screen displays , then you can input any number key between **STEP1** and **VOICE9**. The station will be stored into the transceiver's chip, you can listen this station next time.  
The transceiver has two groups radio-channels storable. When storing, the default is on the 1<sup>st</sup> group storage.  
**E.g.** if you want to store 88.1MHz into the 1st group Channel 8, just press **MENU** + **W8**. If you want to store this frequency into the 2<sup>nd</sup> group Channel 8, firstly, you should select the 2<sup>nd</sup> storage, press **→#**, the screen displays , then switch to the 2<sup>nd</sup> storage, then press **MENU** + **W8** to store into the 2<sup>nd</sup> group Channel 8.  
For the stored station, under the Radio mode, press number key 1 to 9 to listen it. Use **→#** to select the stored stations in 1<sup>st</sup> and 2<sup>nd</sup> storage.
- **Exit the Radio:** Press Side key 1 again to exit the radio mode.

### NOTE

- » When you are listening to the radio, the current frequency or channel still working. Once received signals it will return to the transceiver communicating. After signals disappeared 5 seconds return to Radio mode.
- » When you are listening to the radio, press **EXIT** to check the standby frequency. Press PTT to transmit, 5 seconds later it will return to the Radio mode automatically.

27

## How to operate

### Working Mode (CH-MDF) --- MENU 21

This transceiver has two working modes available:

1. Frequency mode (FREQ)
2. Channel mode

Three kinds of channel mode available:

- ① Channel (CH)
- ② Frequency + Channel number (CH FREQ)
- ③ Channel name (NAME)

#### NOTE

- » Only input the shift password can change Frequency mode into Channel mode, while change among the three kinds of channel mode without inputting password.
- » To set the shift password via KG-UVD1 programming software.
- » Set the password with six "0" is invalid (turn off the Shift password function) while set not full of "0" is valid.

### Frequency (FREQ) and Channel mode changeable

#### ① Invalid password

In standby, press **MENU** + **SOL2** **STEP1** , then press **▲** / **▼** to choose working mode press **MENU** to confirm.

#### ② Valid password

In standby, press **MENU** + **SOL2** **STEP1** , then press **▲** / **▼** to choose working mode press **MENU** to confirm, the screen displays six short line   
Input the password, the transceiver shift to the selective mode.

#### NOTE

- » Channel mode and channel name mode can shift only after stored at least one channel and one named channel.

### Setting Auto Backlight (ABR) --- MENU 22

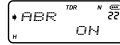
In standby, press **MENU** + **SOL2** **SOL2** , the screen displays   
Press **MENU** to enter, it shows 'ON', press **▲** / **▼** to select ON/OFF auto backlight function, then press **MENU** to confirm, press **EXIT** return to standby.

#### NOTE

- » When the function sets "ON" for opening the auto backlight, it means only when you press the number key, the backlight is opened. The backlight is closed when transmitting or receiving.
- » Shortcut Switch on Frequency Mode and Pure Channel Mode  
In standby, press **MENU** + **TDR** key to switch the mode. Without password, you can switch it directly.  
Otherwise, you have to input the password firstly.

## How to operate

### Setting Offset Frequency (OFF-SET) --- MENU 23

Offset frequency means the difference between Tx and Rx frequency. This transceiver's offset frequency range is between 0 to 69.950MHz.

In standby mode, press **MENU** + **SOL2** **SAVE3**, the screen displays 

Press **MENU** to enter, then press **▲** / **▼** to select offset frequency or input the offset frequency through key pad directly press **MENU** to confirm, press **EXIT** return to standby.

Setting frequency shift direction and offset frequency only in Frequency mode, as for receiving and transmitting in different frequencies.

Operating steps:

1. Set the working frequency
2. Set the frequency shift direction and offset frequency.

**E.g.:** In frequency mode, the transceiver needs to work on receiving frequency 450.025MHz and transmitting frequency 460.026MHz

In Frequency mode, input **TXP4** **RCR5** **0** **0** **SOL2** **RCR5** then press **MENU** + **SOL2** + **TXP4** + **MENU** to select positive direction (+), press **MENU** + **EXIT**, then press **MENU** + **SOL2** + **SAVE3** + **MENU** + **▲** / **▼** to choose 10.000+ **MENU** + **EXIT**, the frequency shift direction and offset frequency set.

30

The screen displays ,

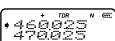
press PTT to transmit and the screen displays .

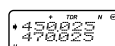
Release PTT the screen displays ,

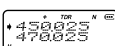
it means receiving frequency is .

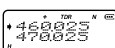
and transmitting frequency is .

### Setting Frequency Shift Direction (SFT-D) ---- MENU24

Shift direction means that:

1. The transmit frequency is higher than receive frequency. This is called positive offset (+).
2. The transmit frequency is lower than receive frequency. This is called negative offset (-).
3. Turn off frequency shift

In standby mode, press **MENU** + **SOL2** **TXP4**, the screen displays 

Press **MENU** to enter, press **▲** / **▼** to select +/-/OFF, then press **MENU** to confirm, press **EXIT** return to standby.

31

## How to operate

### Setting Stopwatch Timer (SECOND) --- MENU 25

In standby mode, press **MENU** + **SOL2** **5**, the screen displays 

Press **MENU** to enter, it shows 'OFF', then press **▲** / **▼** to turn ON/OFF this function, press **MENU** to confirm, press **EXIT** return to standby.

#### Using the stopwatch timer:

When this function is ON, press **→#** to start counting, while press any key to stop. Press **→#** again to start counting.

### NOTE

» Stop counting, press any key (except **→#** key) to exit stopwatch timer function.

### Channel Name Edit (CHNAME) --- MENU 26

Edit Channel name:

1. Channel name should be within 26 letters (A to Z) and 10 numbers (0 to 9).
2. Channel name should be less than six length.
3. When selecting (-) means the bit is blank.

32

#### Edit method:

1. Via programming software.
2. Via keypad of transceiver.

#### Editing:

1. At least one channel should have been stored.
2. The transceiver should be in Channel mode.
3. Enter channel name edit, press **▲** to select character while press **▼** to select edit position.

#### Edit step:

1. Firstly please set the work mode as NAME display way.
2. Select the desired edit channel, press **MENU** + **SOL2** + **TOT6** + **MENU**, the screen displays six '-' symbols, press **▲** to select characters and press **▼**, then press **▲** again to select the second characters, after selecting the sixth character press **MENU** to confirm, press **EXIT** to exit. The screen displays the channel name and also the channel number on top right corner.

33

## How to operate

### Setting Memory Channels : Setting Co-Channel and Dis-Channel (MEM-CH) --- MENU 27

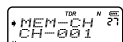
In Frequency mode and in standby, you can input the desired storing frequencies and each parameter. press **MENU** + **SQ2** **VOX7** , the screen displays 

Press **MENU** to enter, press **▲** / **▼** to select channel, then press **MENU** to store, a voice prompt means receiving stored. Press **EXIT** to exit, the current channel is co-channel. If you need to store dis-channel, repeat the above operation, another voice prompt means sounds – transmitting stored.

**E.g.:** setting 450.025MHz as receiving frequency and 460.025MHz as transmitting frequency which stored in CH-20, then set as following:

1. In Frequency mode, input **TXP4** **RECE5** **0** **0** **SQ2** **RECE5** + **MENU** + **SQ2** **VOX7** + **MENU** , then press **SQ2** **0** or **▲** / **▼** to select CH-20, press **MENU** to confirm, voice prompt means receiving stored, then press **EXIT** .
2. Input **TXP4** **TOT6** **0** **0** **SQ2** **RECE5** + **MENU** + **SQ2** **VOX7** + **MENU** + **MENU** , voice prompt means transmitting stored, then press **EXIT** .
3. The dis-channel is stored.

34

### NOTE

- » If the stored channels need to set the CTCSS/DCS codes, you should set it before you stored, in case to stored into channel with frequency.
- » Transmitting store only can store transmit frequency.
- » Manual store, in frequency mode, only desired storing channel is empty can set receiving and transmitting store, or only can set transmitting store. If the channel had been edited, it can set receiving and transmitting store only after deleting the channel.
- » Besides manual store, via programming software can also set the functions and parameters.

### Deleting Channel (DEL-CH) ----- MENU 28

In standby mode, press **MENU** + **SQ2** **WAX8** , the screen displays 

Press **MENU** to enter, and press **▲** / **▼** to select the desired deleted channel, then press **MENU** to confirm, the selected channel and message are deleted, press **EXIT** return to standby.

35

## How to operate

### Setting Reset ---- MENU 29

This transceiver has two resets available - VFO and ALL messages.

When you use RESET VFO, all function parameters will return to default set.

When you use RESET ALL, the transceiver's all settings return to default set.

#### 1. MENU Reset (VFO):

In standby mode, press **MENU** + **SQ2** **VOX9**, the screen displays 

Press **MENU** to enter, and press **▲** / **▼** to select VFO, then press **MENU**, the screen displays , press **MENU** again to confirm, and the screen displays .

After set Reset, the transceiver will auto power off and reboot again.



#### 2. All messages Reset (ALL)

To avoid disoperation, you can set the password of ALL messages Reset (ALL) for this transceiver through Programming software. All messages reset will only work after the right password is input. Pls see the Programming software for the setting of password, 6 figures, while setting "000000" means cancelling the password lock function.

##### (1). Setting password as "000000"

In standby, press **MENU** + **SQ2** **VOX9**, the screen displays 

36

Press **MENU** to enter, and press **▲** / **▼** to select ALL, press **MENU**, the screen displays , then press **MENU** again to confirm, the screen displays , when the reset is finished, the transceiver will automatically turns off and reboot again.

##### (2). Setting password as "XXXXXX" (E.g.: 123456)

In standby, press **MENU** + **SQ2** **VOX9**, the screen displays 

Press **MENU** to enter, and press **▲** / **▼** to select ALL, press **MENU**, the screen will displays 

at this time input the six figure password (e.g.: 123456), the screen displays 

the transceiver will start resetting. After reset is finished, transceiver will automatically turns off and restart.

37



## How to operate

### CTCDD/DCS Frequency Scan ----- MENU 30

This function is to scan all CTCSS or DCS frequencies to confirm if the transmitting party has the CTCSS or DCS frequencies to transmit. When CTCSS or DCS frequencies are not matched between you and other members in the same group, you can use this function to confirm CTCSS or DCS frequencies.

When the transceiver is in receiving, press **MENU** + **SAVE** **3** **0** , the screen displays 

Press **MENU** to enter, the arrowhead points to "CTCSS". Press **▲** / **▼** select to scan CTCSS or DCS.

And then press **MENU** to confirm, it starts scanning CTCSS/DCS frequencies.

#### NOTE

- » This function can not work under the channel mode.
- » The function can not start up without detecting signals.
- » Press **▲** / **▼** or turn code switch to reverse the scanning direction.
- » When identifying CTCSS or DCS frequencies, the identified frequency will display on screen. In this moment, you can press **MENU** instead of present CTCSS or DCS frequencies temporarily. If you need direct replacement, please enter CTCSS menu (Menu 15 & Menu 16) or DCS menu (Menu 17 & Menu 18) to save and confirm. Otherwise, the value will come back to the prior one after restoration.
- » Only when the band that the arrowhead points receives signal, the transceiver can enter CTCSS/DCS frequency to scan.

### DTMF Encoding

**MENU** , **▲** , **▼** , **EXIT** are corresponding to A, B, C, D on DTMF

Please follow the below steps to dial up manually:

1. Press PTT key to transmit.
2. In the meantime of transmission, press the key, and the corresponding DTMF tone is sent out.

#### NOTE

- » The transceiver transmits the corresponding tone, which can be monitored by the speaker.

### ANI ID Code Edit, ANI ID Code Transmit, ANI ID Code Transmit Delay and Setting DTMF Sidetone

#### NOTE

- » The above functions in this transceiver only can be edited by our programming software.

#### ANI ID Code Edit

ANI ID Code can be edited by 6 digits, which is made up of A, B, C, D and 0-9.

#### ANI ID Code Transmit

## How to operate

Switch of ANI ID Code Transmit means that when you are communicating, press [PTT] key every time, the ANI ID CODE will be auto or manual transmitted. Selecting ON means automatically transmit, OFF means manually transmit.

### ANI ID Code Transmit Delay

ANI ID Code Transmit Delay means when you are communicating, press [PTT] key every time to delay transmit ANI ID Code automatically.

The longest time of ANI ID Code auto transmit delay is 3seconds, which is divided into 30 levels and 100ms per level.

### Setting DTMF Sidetone

DTMF sidetone gives you the opportunity to switch on or off the speaker and hear the relative DTMF tone when transmit DTMF.

**There are 4 options on setting sidetone:**

- ① Key Tone: In transmitting, press number key to open the sidetone.
- ② ANI ID Code Transmit Sidetone: Opening sidetone when the transceiver transmits ANI ID code.
- ③ Key tone + ANI ID Code Transmit Sidetone: In transmitting, opening side tone by number key or during transmitting ANI ID code.
- ④ Turn off Sidetone: In encoding, all sidetone turns off.

40

### Setting Priority Scan Function

If you want to monitor the other frequency and check the certain preferred frequency at the same time, you can set Priority scan function.

**E.g.:** Scan six channels: CH1, CH2, CH3, CH4 and CH5 as the common scanned channel, and CH6 set as the priority scanned channel. Scanning sequence as following chart:

CH1 – CH6 – CH2 – CH6 – CH3 – CH6 – CH4 – CH6 – CH5 – CH6



If the transceiver checks the signal on "Priority Channel", it will call out its frequency.

Select the priority channels via programming software.

### Setting Reverse Frequency Function

When using reverse frequency function, the transmitting and receiving frequency of transceiver will interchange, and the CTCSS and DCS encode and decode will interchange either.

**Operating reverse frequency function:**

In standby mode, press  to turn on the reverse frequency function; press  again to turn off.

**In Frequency Mode:**

1. If the menu setting turns on

## How to operate

2. If your transceiver permits reset

The editing method of the above two functions: via software

### Low-voltage Battery Voice Prompt

When the battery pack has low voltage, the transceiver will sound "low battery pack", and the LED will flash every 5 seconds and a "click" sounds.

### Transmit Overtime Prompt

When transceiver transmits beyond the limited time, there will be a sound warning "transmit overtime", and stop transmitting. Press PTT to transmit again. (Setting Transmit Over Timer pls see page 16)

### Adding Scanning Channel

#### NOTE

- » Channel scan only according to scan list which had been added.
- » Edit method: Strictly via programming software.

### Wire Clone Function

Using wireclone	Switch sourceradio on, after you have connected the targetradio to the sourceradio via the cloningcable, push the [MONI] key and the sourceradio starts cloning.	LED is flashing red during cloning. LED goes out in case of successful cloning. LED glows continuous red in case of cloning failure.
	Targetradio	LED is flashing green during cloning. LED will switch OFF when cloning complete.

### Working with Repeater

This transceiver has two working modes while working with repeater.

- ① Frequency mode working with repeater      ② Channel mode working with repeater

#### 1. Frequency mode working with repeater

- ① Press **A/B** to choose band A, set the Tx frequency and sub-tones which need to work with the repeater.
- ② Press **A/B** to choose band B, set the Rx frequency (if the repeater has TX sub-tones, you can also set sub-tones in band B).
- ③ Press **MENU** + **TDR**, frequency mode working with repeater set. The TDR disappeared but the screen displays "  ". And then press **A/B** again, the setting is finished.

## How to operate

### 2. Channel mode working with repeater

- ① Edit the Tx & Rx frequency and sub-tones on the channel which need to work with repeater.
- ② In channel mode, and call out the above edited channel, press **A/B** to set this channel as the current one.

### How to Use the Intelligent Charger

1. Insert the AC plug into the outlet (AC: 90-240V), the charger indicator flashes, it means enter charging standby .
2. Insert the battery into the charger, the RED indicator turns on, it means charging, while GREEN indicator turns on, it means fully charged.

#### **NOTE**

- » When insert the exhausted battery pack into the charger, it pre-charge the battery pack in trickling charge, meanwhile, the RED light flashing and lasts 10 to 20 minutes, then enter normally charging with RED light on, it will turn to GREEN when fully charged.
- » Tricking charge the exhausted battery pack in case to protect the Li-ion battery.

## Trouble shooting

Please check carefully if your transceiver has problems by following this chart.

If you maintain to have trouble you can reset your transceiver and very often this will eliminate your problem.

<b>Problem</b>	<b>Solution</b>
Cannot power on, no power	<ol style="list-style-type: none"><li>1. The battery may exhausted, pls change the new battery or re-charge.</li><li>2. The battery install incorrect, pls take out the battery and re-install.</li></ol>
Battery life not long	<ol style="list-style-type: none"><li>1. The battery life is over, pls change a new battery.</li><li>2. Not charging completely, be make sure fully charged before take out.</li></ol>
Receive light turn on but no sounds	<ol style="list-style-type: none"><li>1. Make sure the volume is highest</li><li>2. Make sure the CTCSS/DCS code is the same with other members.</li></ol>
Keypad do not work	<ol style="list-style-type: none"><li>1. Make sure the keypad is locked or not.</li><li>2. Make sure any other key stuck.</li></ol>
In standby, it will auto- transmit without pressing PTT	Make sure VOX function is ON or not, and its level is set too low or not.

## Trouble shooting

<b>Problem</b>	<b>Solution</b>
Some functions can not be stored	Make sure work in Channel mode. Some functions can be set only via programming software in Channel mode.
Receive other groups signal while communicating	Pls change another CTCSS/DCS code of your group.

## Technology parameter

### Appendix 1

<b>CTCSS</b>									
1	67.0	11	94.8	21	131.8	31	171.3	41	203.5
2	69.3	12	97.4	22	136.5	32	173.8	42	206.5
3	71.9	13	100.0	23	141.3	33	177.3	43	210.7
4	74.4	14	103.5	24	146.2	34	179.9	44	218.1
5	77.0	15	107.2	25	151.4	35	183.5	45	225.7
6	79.7	16	110.9	26	156.7	36	186.2	46	229.1
7	82.5	17	114.8	27	159.8	37	189.9	47	233.6
8	85.4	18	118.8	28	162.2	38	192.8	48	241.8
9	88.5	19	123.0	29	165.5	39	196.6	49	250.3
10	91.5	20	127.3	30	167.9	40	199.5	50	254.1

Appendix 2

**DCS**

1	D023N	16	D074N	31	D165N	46	D261N	61	D356N
2	D025N	17	D114N	32	D172N	47	D263N	62	D364N
3	D026N	18	D115N	33	D174N	48	D265N	63	D365N
4	D031N	19	D116N	34	D205N	49	D266N	64	D371N
5	D032N	20	D122N	35	D212N	50	D271N	65	D411N
6	D036N	21	D125N	36	D223N	51	D274N	66	D412N
7	D043N	22	D131N	37	D225N	52	D306N	67	D413N
8	D047N	23	D132N	38	D226N	53	D311N	68	D423N
9	D051N	24	D134N	39	D243N	54	D315N	69	D431N
10	D053N	25	D143N	40	D244N	55	D325N	70	D432N
11	D054N	26	D145N	41	D245N	56	D331N	71	D445N
12	D065N	27	D152N	42	D246N	57	D332N	72	D446N
13	D071N	28	D155N	43	D251N	58	D343N	73	D452N
14	D072N	29	D156N	44	D252N	59	D346N	74	D454N
15	D073N	30	D162N	45	D255N	60	D351N	75	D455N

**DCS**

76	D462N	82	D516N	88	D606N	94	D645N	100	D723N
77	D464N	83	D523N	89	D612N	95	D654N	101	D731N
78	D465N	84	D526N	90	D624N	96	D662N	102	D732N
79	D466N	85	D532N	91	D627N	97	D664N	103	D734N
80	D503N	86	D546N	92	D631N	98	D703N	104	D743N
81	D506N	87	D565N	93	D632N	99	D712N	105	D754N

## Technology specification

Frequency Range (can be suitable for different countries or areas):	76-108 MHz (Rx) 136-174MHz & 350-470MHz (Rx / Tx), 136-174MHz & 420-520MHz (Rx / Tx), 136-174MHz & 245-250MHz (Rx / Tx), 136-174MHz & 225-226MHz (Rx / Tx),	136-174MHz & 400-480MHz (Rx / Tx), 136-174MHz & 400-470MHz (Rx / Tx), 136-174MHz & 216-280MHz (Rx / Tx), 136-174MHz & 430-440MHz (Rx / Tx).
Memorychannels	128 channels	
Operating Voltage	7.4V	
Operating Temperature	-30°C to + 60°C	
Working Mode	Co-channel or Dis-channel simplex	
Output Power	VHF: 5W / UHF:4W	
Modulation	F3E(FM)	
Max. Frequency Deviation	≤ ±5KHz	
Spurious Radiation	< -60dB	
Frequency Stability	±2.5 ppm	
Receive Sensitivity	< 0.2 μV	
Audio Output power	≥ 500mW	
Dimension	58 X 105 X 39 (mm)	
Weight	250g	

### NOTE

» Specifications are subject to change without notice.

50

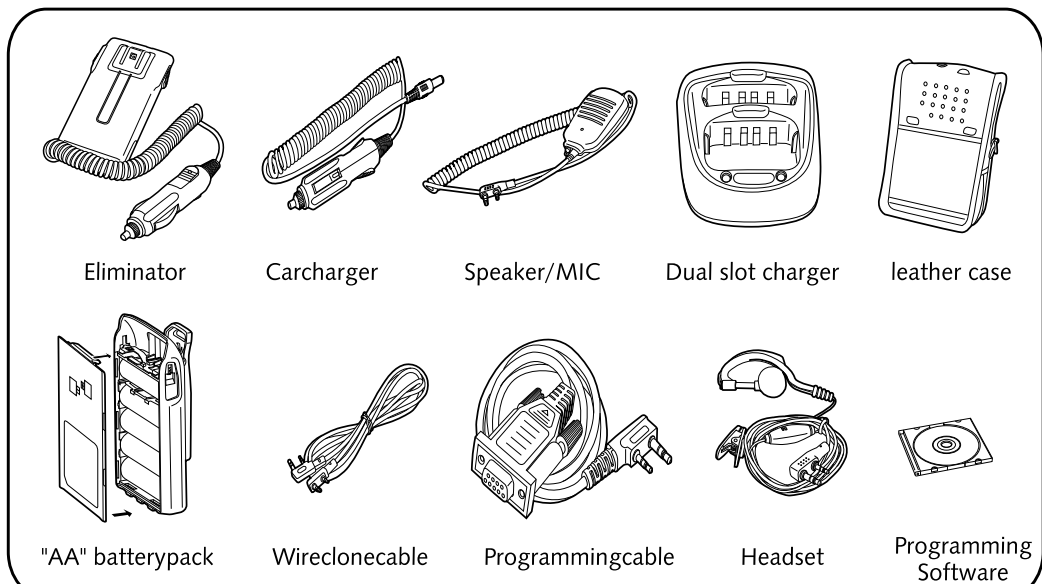

## Optional accessories

 Professional FM Transceiver



51

## Announce

 **Wouxun** endeavors to achieve the accuracy and completeness of this manual, but is not liable for any possible emission and printing errors. All the above specifications are subject to change by  **Wouxun** without prior notice.

English Version: 0906-V3

## DECLARATION OF CONFORMITY

We, Quanzhou Wouxun Electronics Co.,Ltd, No.928 Nanhuan Road, Jiangnan High Technology Industry park, Quanzhou, Fujian 362000, China, declare that our product:

Product Description: Two-way Radio

Brand: WOUXUN

Model: KG-UVD1P

is in compliance with the essential requirements and other relevant provisions of the R&TTE directive 1999/5/EC and carries the CE mark accordingly.

Supplementary information:

The product complies with the requirements of:

Low Voltage Directive 2006/96/EC  
-EN 60950-1 : 2006

Efficient use of frequency spectrum  
-ETSI EN 300 086-1 V1.3.1(2008-09)  
-ETSI EN 300 086-2 V1.2.1 (2008-09)

EMC  
-ETSI EN 301 489-1 V1.8.1 (2008-04)  
-ETSI EN 301 489-5 V1.3.1 (2002-08)

Date: June 27, 2009

Place: Quanzhou, Fujian, China

Name: Danny Chen

Signature:



Quanzhou Wouxun Electronics Co.,Ltd.  
Add: No.928 Nanhuan Road, Jiangnan High Technology Industry park, Quanzhou, Fujian 362000, China  
Tel: 0086 595 28051265 Fax: 0086 595 28051267  
Http://www.wouxun.com