

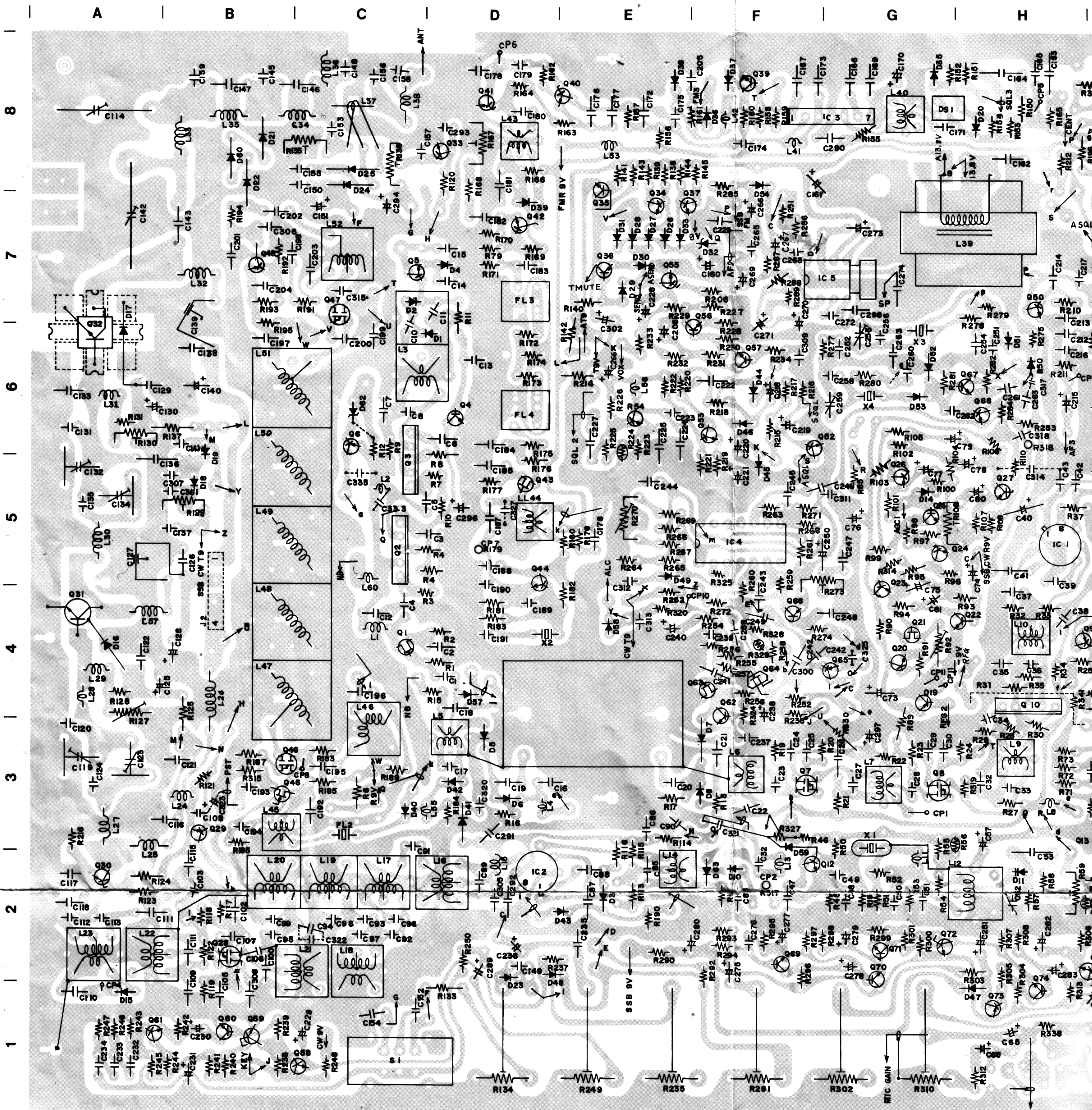

ICOM

IC-251A/E

MAIN UNIT



51A/E BOARD LAYOUT

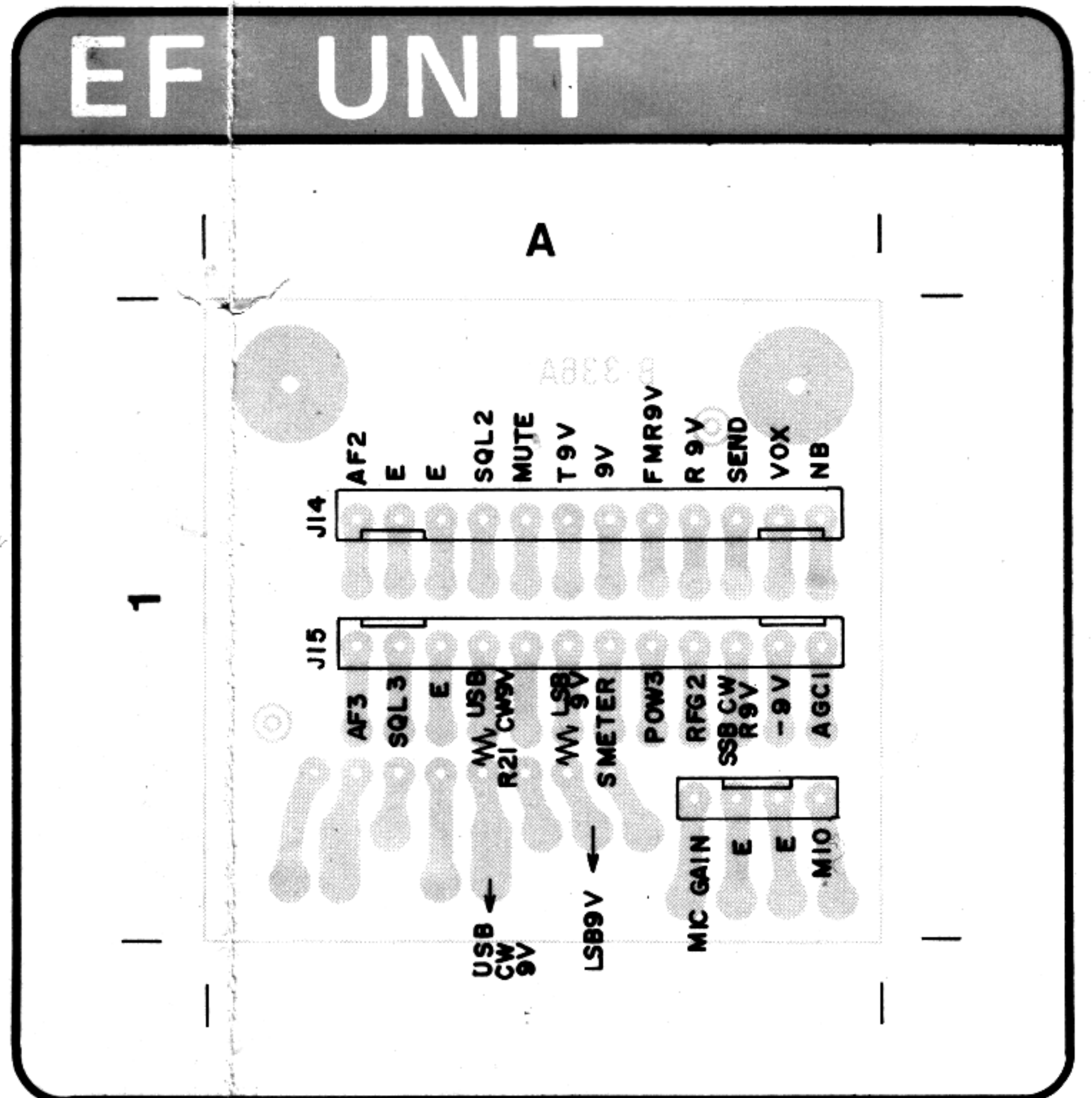
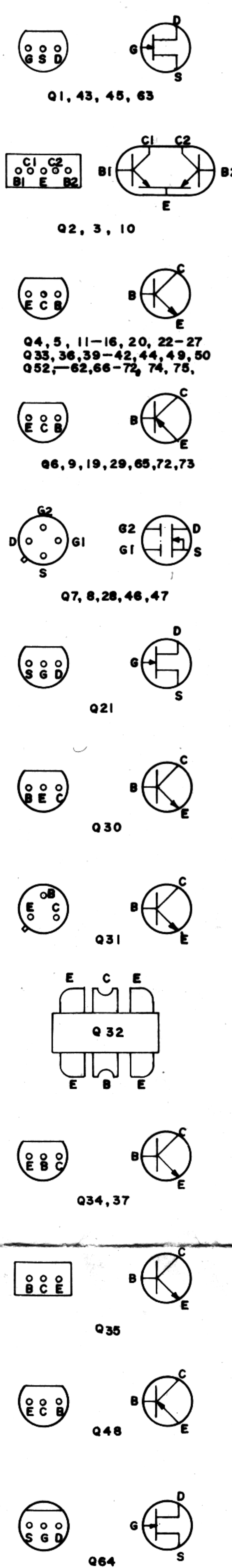
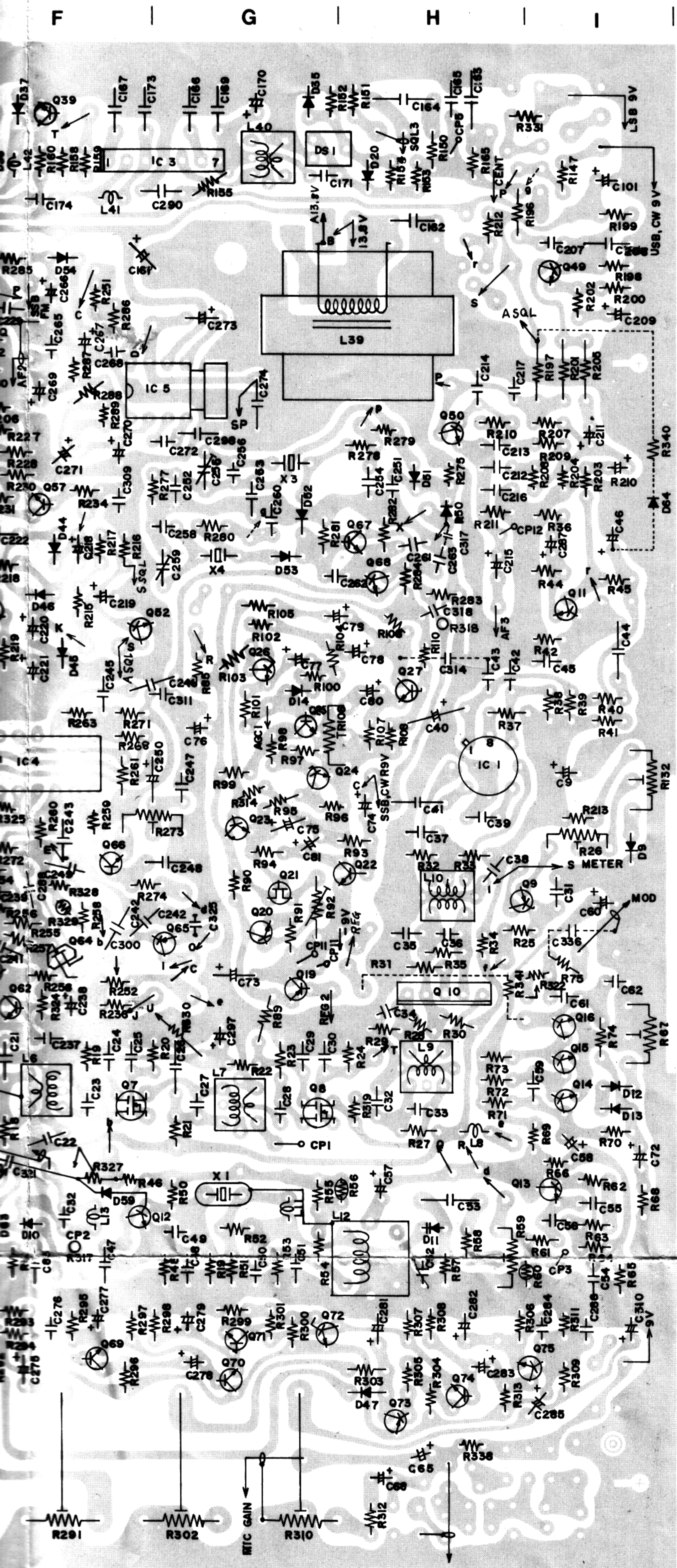

LIMITER BOARD

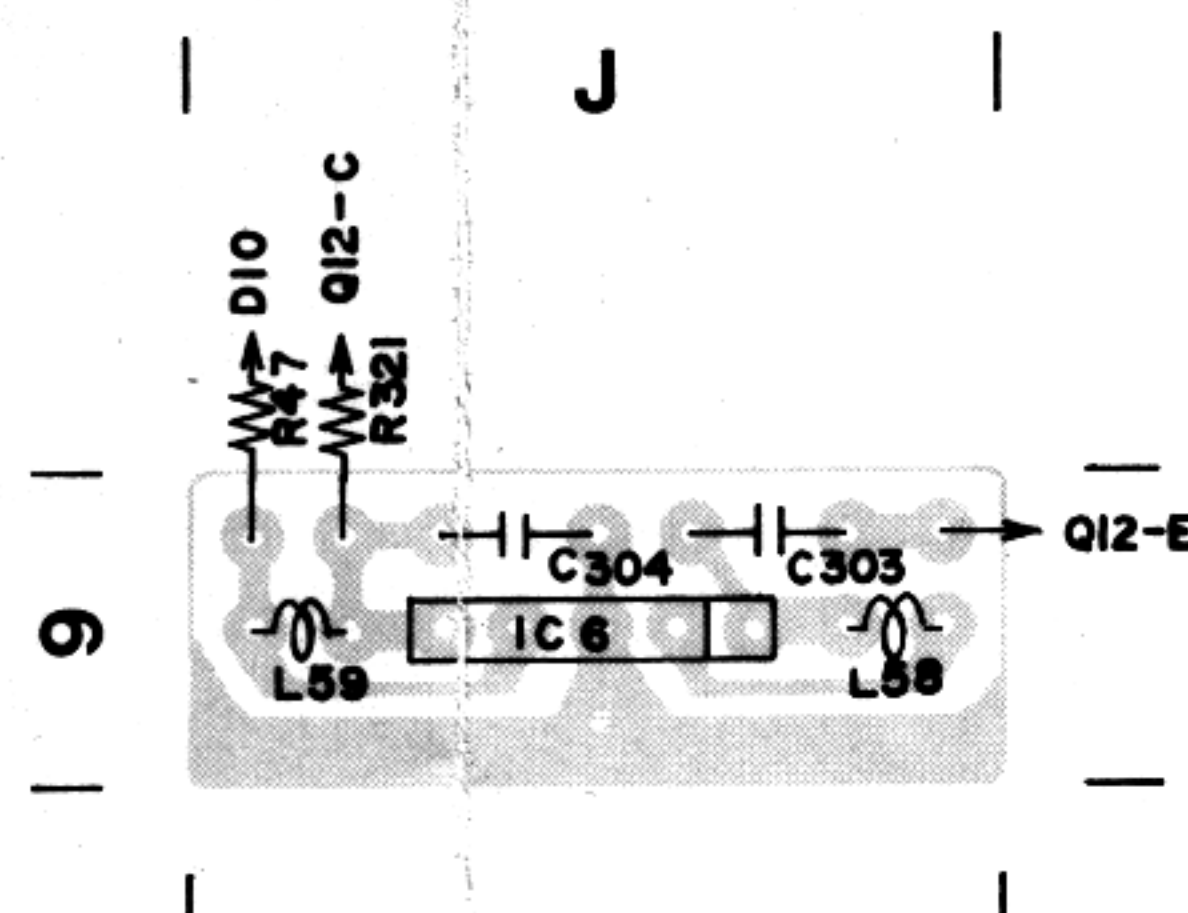

Downloaded by

 Amateur Radio Directory

NOISE BLANKER BOARD

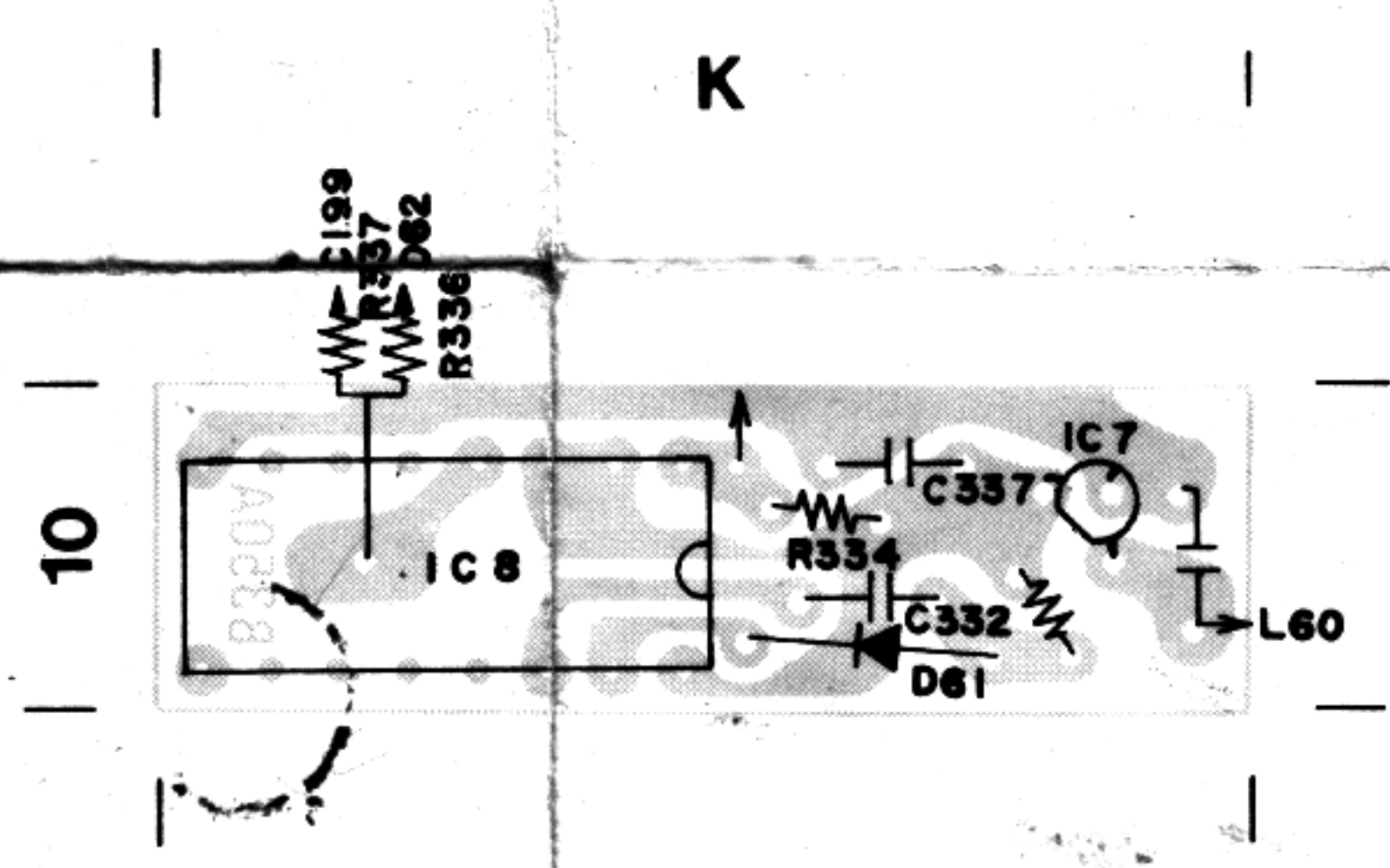

PLL UNIT

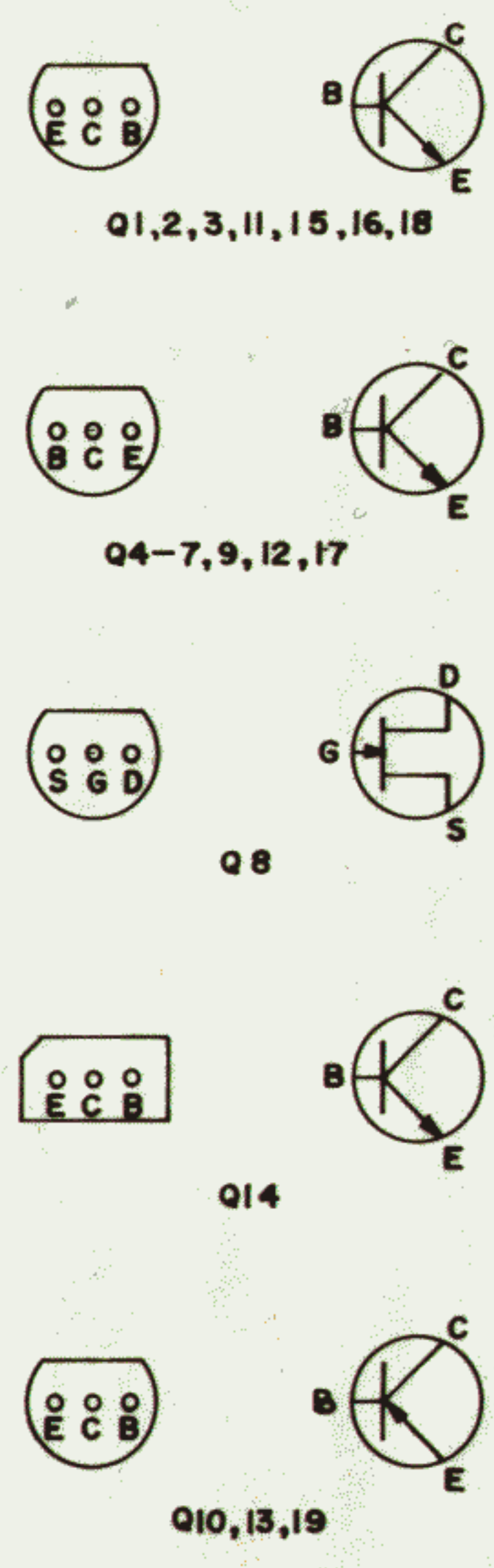
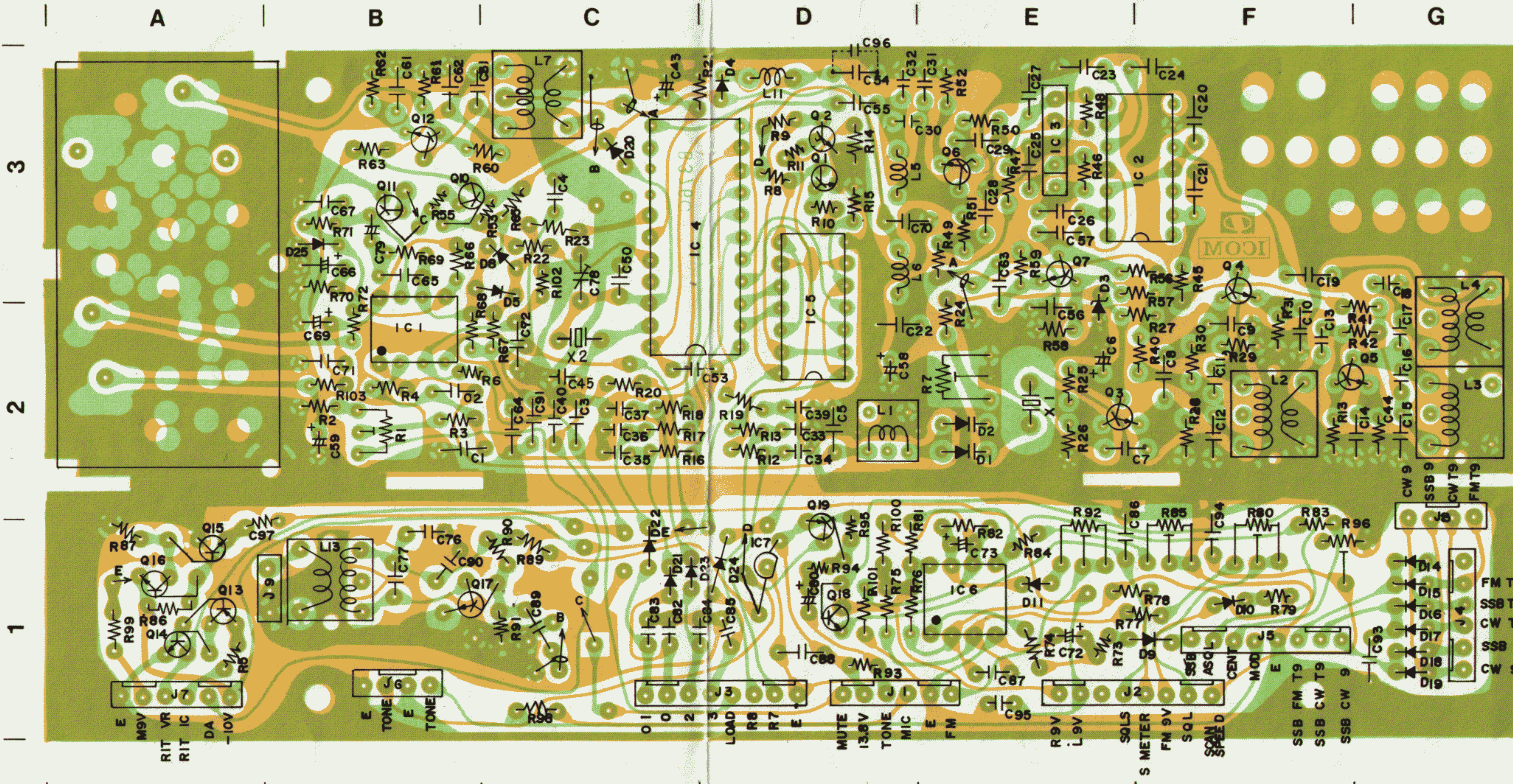

VCO UNIT

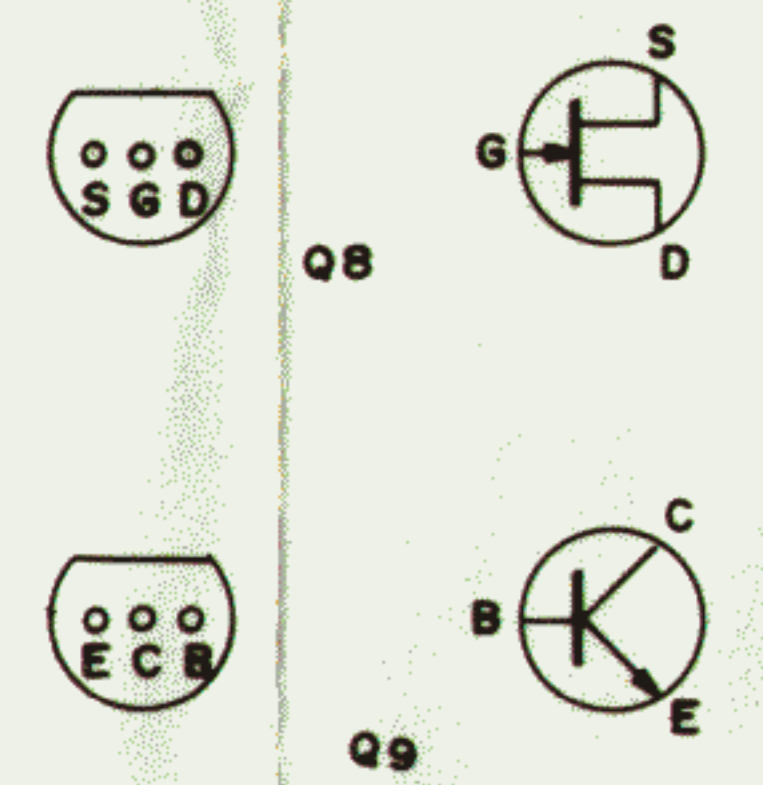
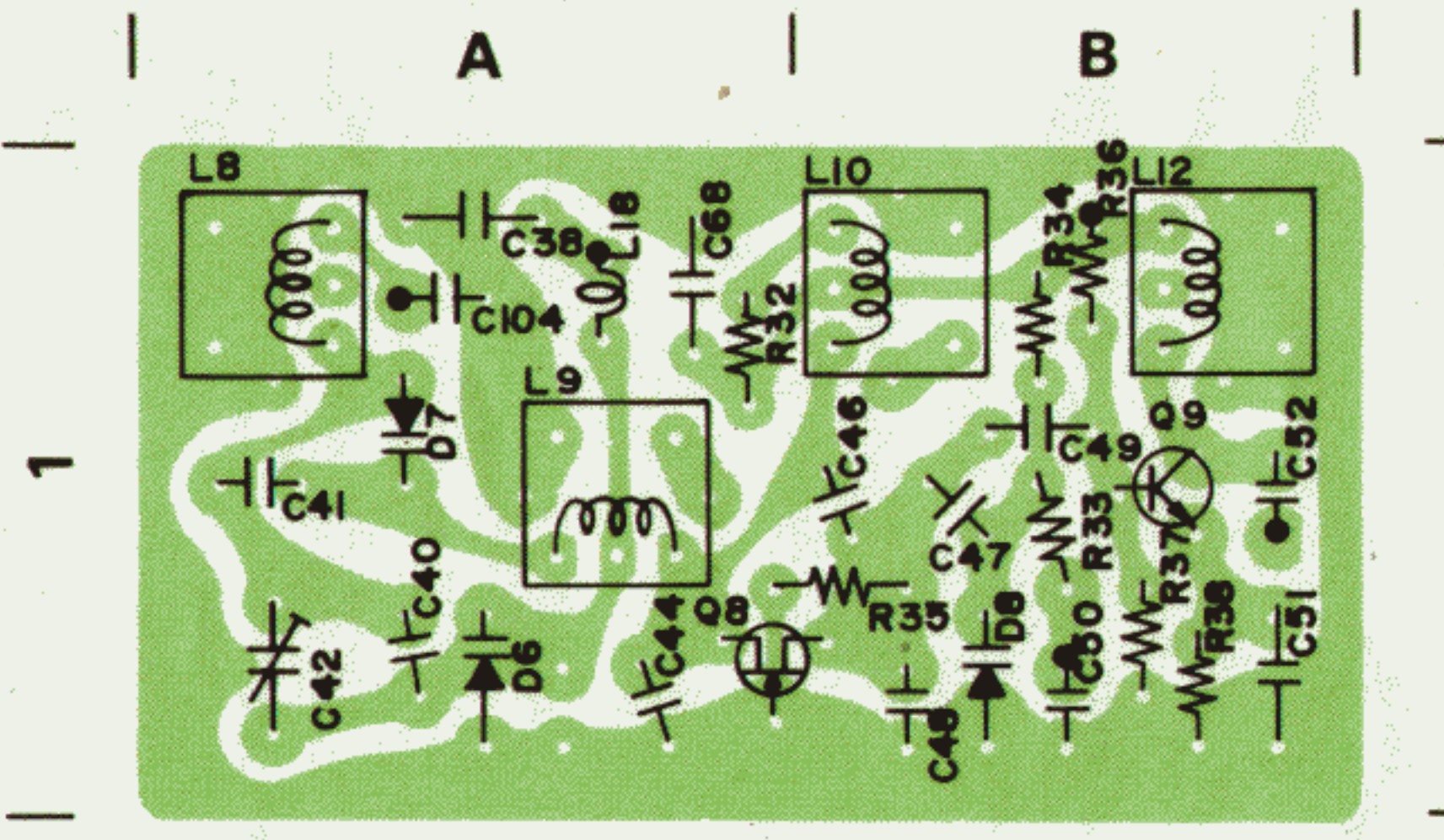

TONE CALL UNIT

(IC-251E ONLY)

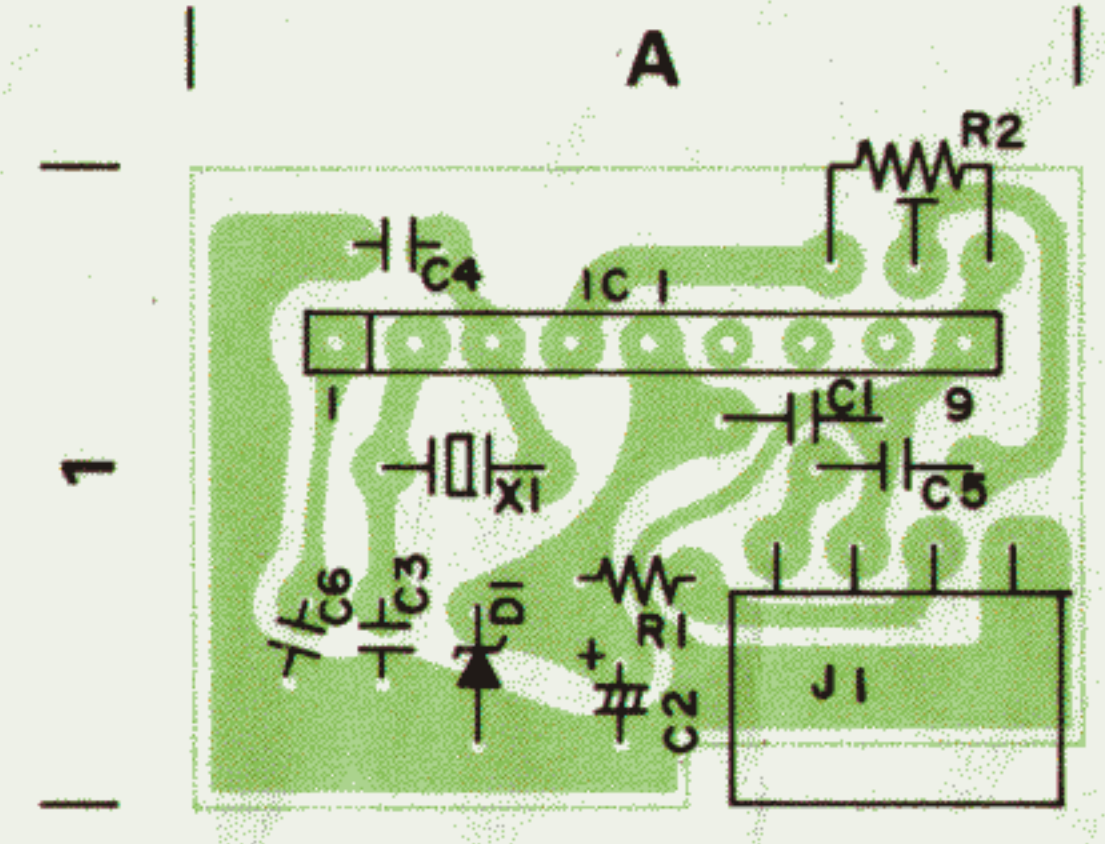

DRIVER UNIT

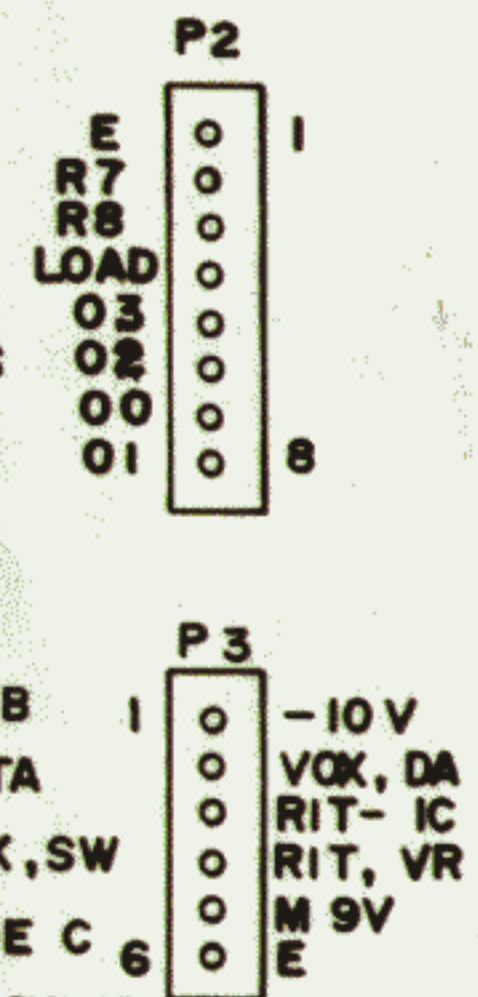
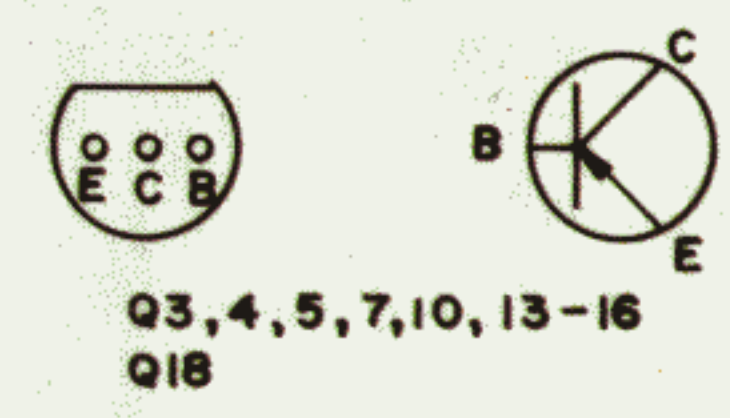
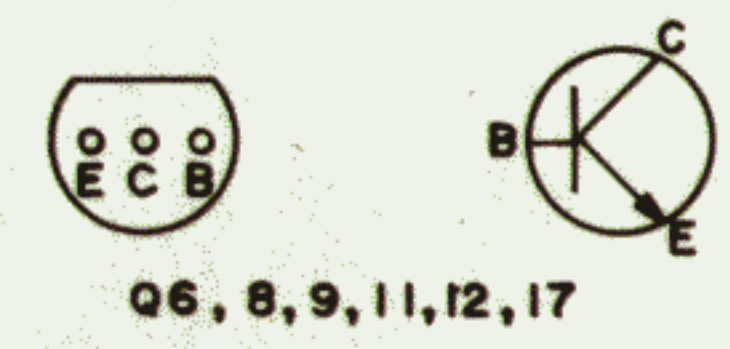
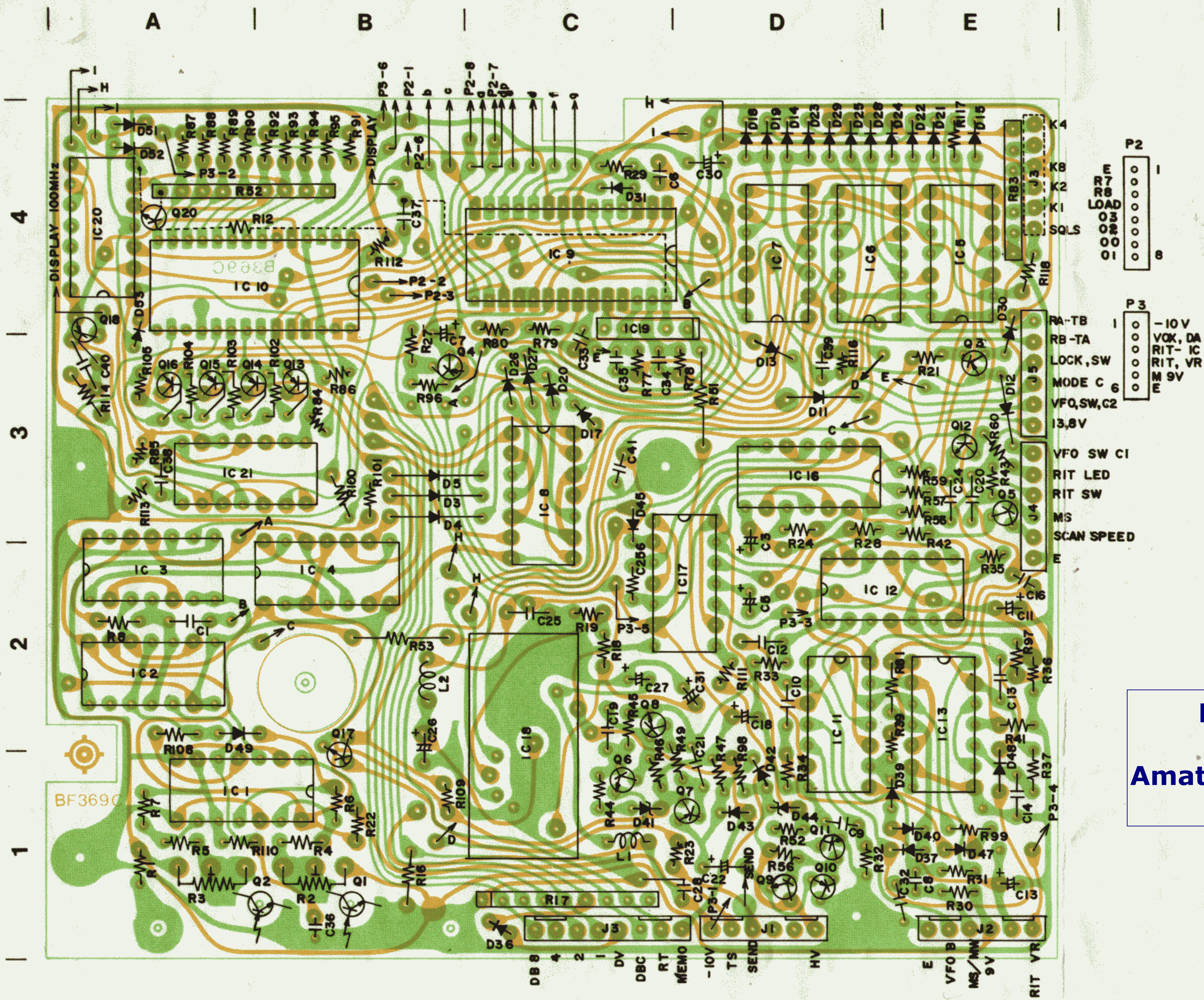

Downloaded by []
 []
 Amateur Radio Directory

■ DISPLAY BOARD

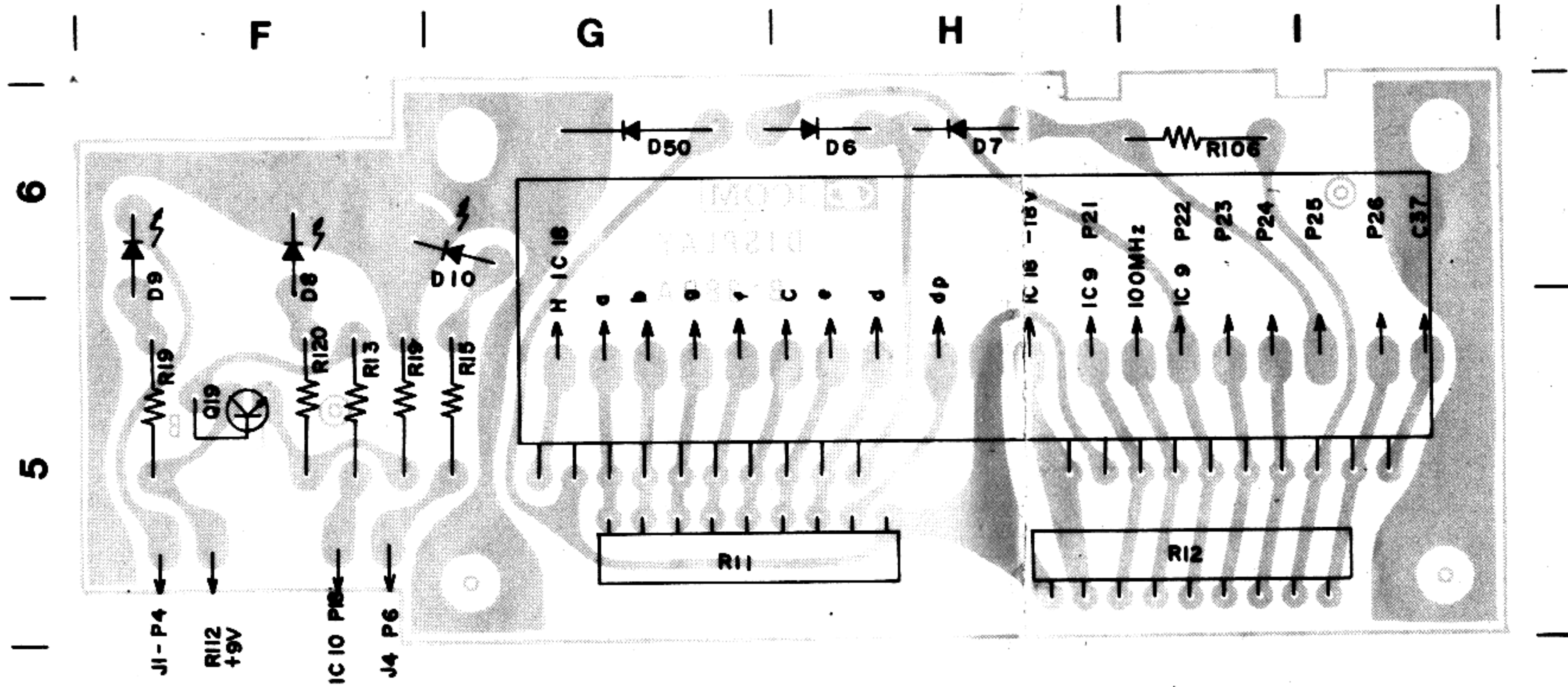

Downloaded by

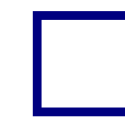

Amateur Radio Directory

■ LEI BOARD

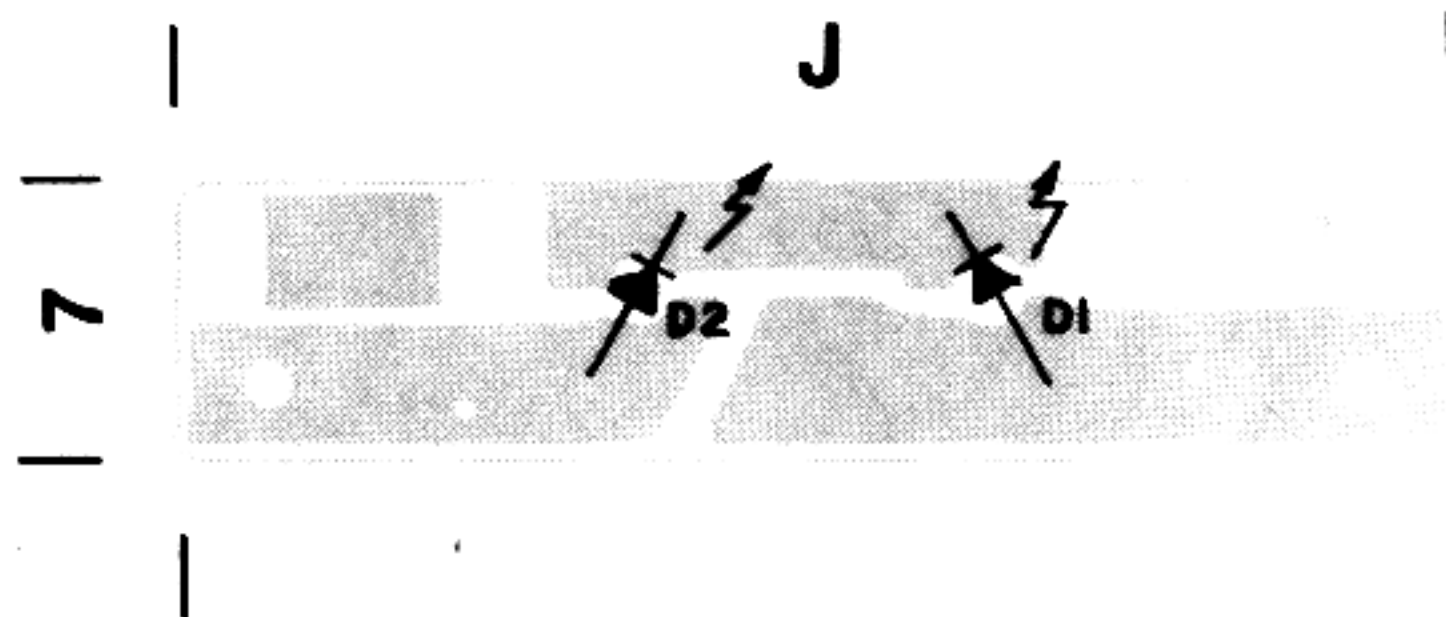

POWER SUPPLY UNIT

SWITCHING REGULATOR BOARD

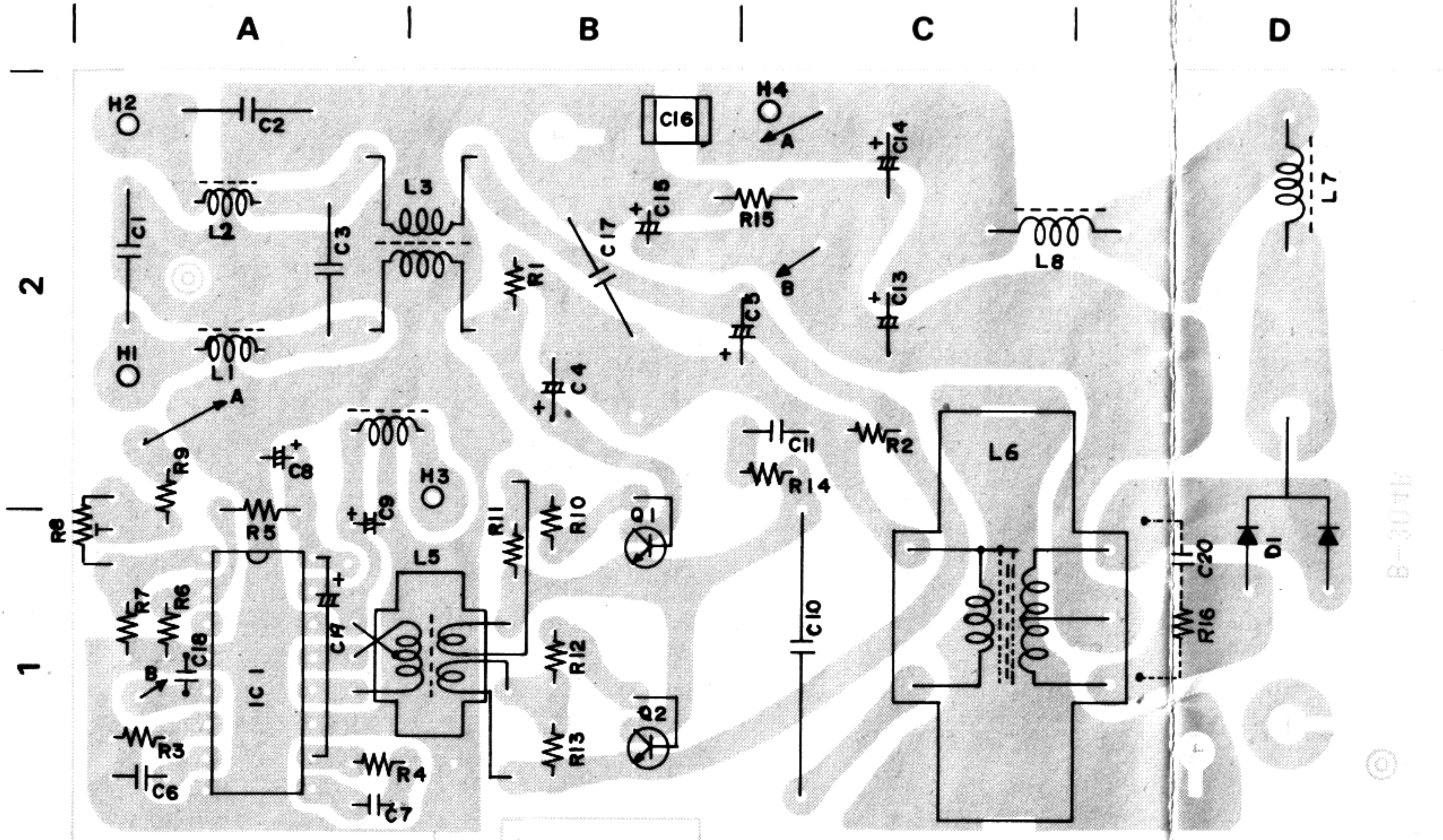

PI BOARD

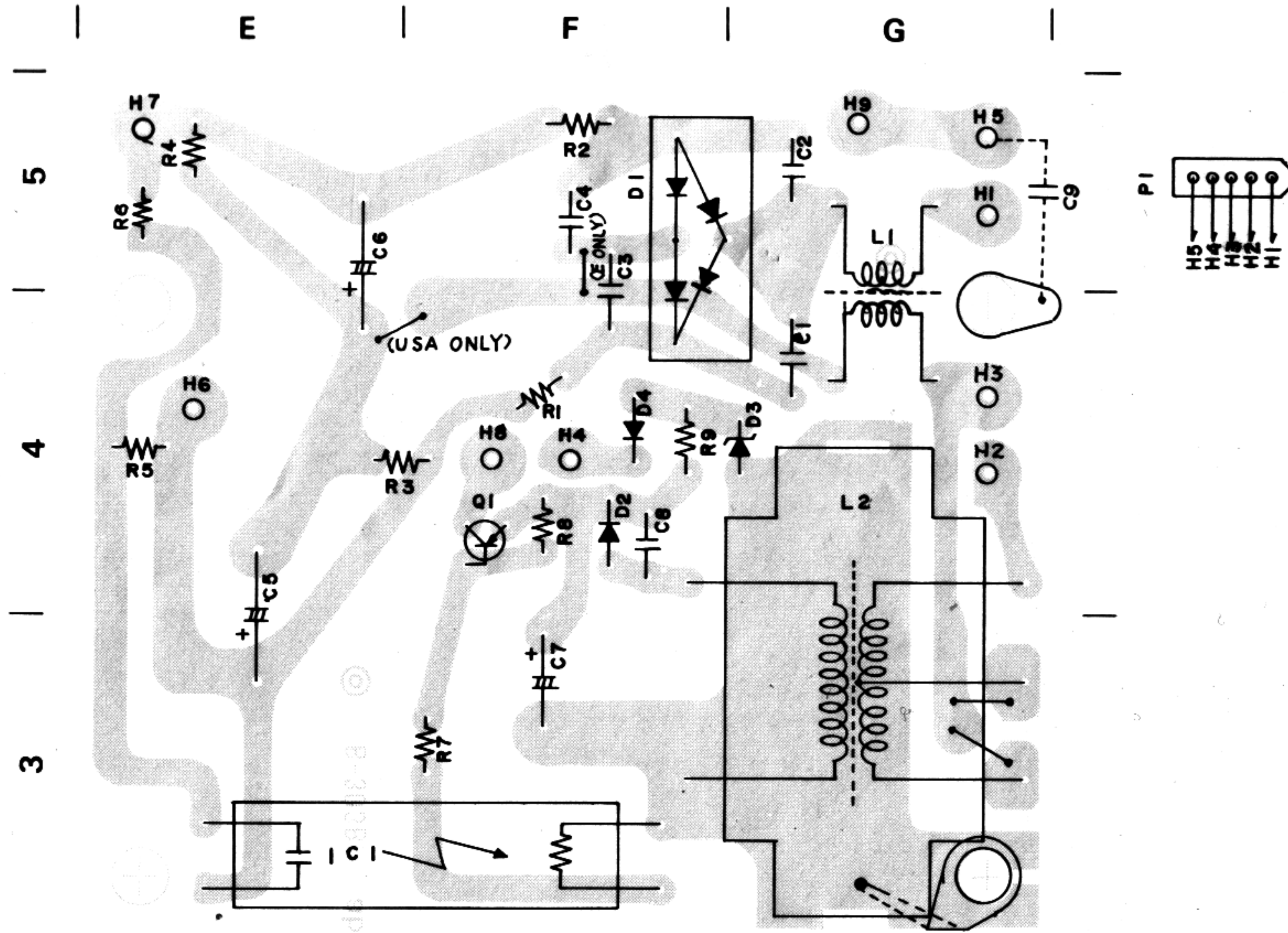

BOARD LAYOUT

