



The New Concept

CU8232

*Remote Control Interface
for the*

AR8000

Hand Portable Radio Receiver

Downloaded by
RadioAmateur.EU

Thank you for purchasing the CU8232 computer control interface for the AR8000 receiver.

Every effort has been made to make this manual correct and up to date. Due to continuous development of the product and by error or omission anomalies may be found and these are acknowledged.

Most apparent faults are usually due to accidental mis-operation of the product, carefully read all of the manual and relevant sections in the AR8000 operating manual before deciding to return the interface for repair.

This manual is protected by copyright AOR LTD 1994. No information contained in this manual may be copied or transferred by any means without the prior written consent of AOR LTD. AOR and the [AOR] logo are trade marks of AOR, LTD. All other trade marks and names acknowledged. E&OE.

(C) 1994 AOR LTD. Japan.

Index

1	General	3
2	Supplied accessories	3
3	AR8000/CU8232 connection & clone	3,4,5,6
4	Connection for RS232 operation	6,7
5	Communication parameters	8
6	WINDOWS TERMINAL	8,9,10,11,12
7	How to send a command	12
8	List of commands	13
9	Command index	14,15
10	Explanation of commands	16 - end

(1) General

The CU8232 interface allows computer control via the RS232 serial port of a computer. An additional piece of software will usually be required in order to address the computer's serial port with the correct set of parameters. If using an IBM-PC or clone (with 80386 processor or higher) Microsoft WINDOWS "TERMINAL" may be used to address the computer's serial port, configuration of "TERMINAL" is covered later in this manual.

In order to gain the greatest flexibility, a specialist software package is desirable. It is planned to later introduce a Microsoft WINDOWS package to support the AR8000 receiver.

The CU8232 interface also enables data to be copied between two AR8000 receiver when simultaneously connected to the CU8232. Memory, search and all data may be transferred enabling full CLONE of one receiver onto another. This may be accomplished without the use of a host computer and the interface is powered from the AR8000 receiver.

(2) Supplied Accessories

Please check that the following items are included in the package:

Description	Quantity
CU8232 remote control interface box	One
Flat cable	Two
RS232C 9-pin to 25-pin adaptor	One
RS232C 9-pin male-Female adaptor	One
English language operating manual (this booklet)	One

(3) AR8000/CU8232 connection & clone

1. A ribbon cable is used to connect the AR8000 to the CU8232. One end of the ribbon cable has a reinforced plate, this is used at the AR8000 end of the connection. Insert one flat cable (they are both identical) into the CU8232 [PROGRAM] socket contact (metal) side downward.

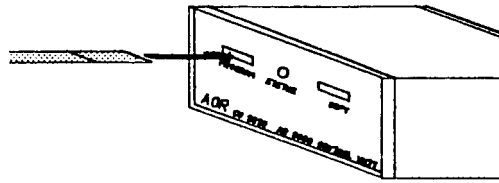

Figure 1

The [PROGRAM] socket is the primary receiver connection used for computer control. This port also takes power from the receiver (when the AR8000 is switched On).

Should you wish to CLONE data between two AR8000 receivers, connect the second ribbon cable to the socket labelled [COPY].

2. Remove the battery compartment lid of the AR8000 using a downward sliding motion.

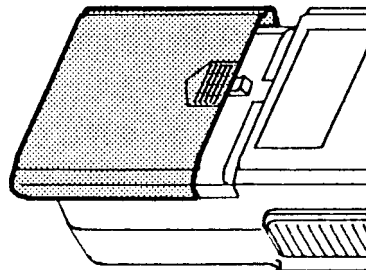

Figure 2

Locate the remote control socket which is located at the bottom edge of the battery compartment. Insert the ribbon cable (with the reinforced plate) contact (metal) side downward.

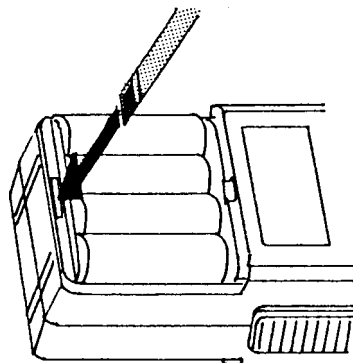

Figure 3

It may be difficult to insert the flat cable into the CU8232 socket for the first time as they are necessarily quite tight. If this is the case, try inserting with a little upward pressure, it should become easier the next time. **DO NOT APPLY EXCESSIVE STRESS TO THE FLAT CABLE UNDER ANY CIRCUMSTANCES.**

A DC voltage is fed to the CU8232 by the AR8000 connected to the [PROGRAM] socket. When the receiver is switched On, the AR8000 DATA is routed to the RS232 connector.

If a second receiver is connected to the [COPY] socket and switched On, the CU8232 recognises it's presence and routes data between receivers and not to the RS232 socket.

3. To CLONE data between two AR8000 receivers, connect each receiver to the CU8232 using a ribbon cable as outlined above. Data may be transferred in BOTH direction between the [PROGRAM] and [COPY] sockets.

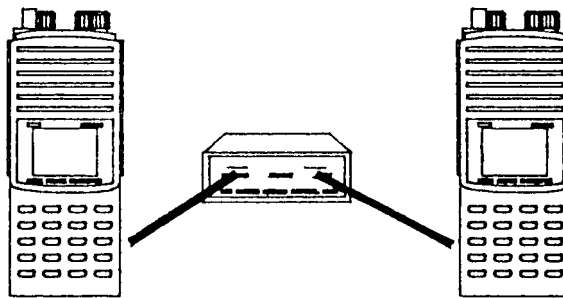

Figure 4

4. Switch both receivers On and run the CLONE functions as detailed on page 102 section 19 of the English language operating manual.

Caution! Make sure that no low / flat batteries occur while the data clone is in progress. Although no significant extra current is required for clone operations, flat batteries may cause corrupted data transfer. It is advisable that the receivers are both powered from their chargers (which were supplied with the receivers) during clone operation.

5. If a data clone fails retry the procedures of clone operation after checking the following:
 - ☆ Make sure that all connections are correct and there is no loose contact.
 - ☆ Ensure that one receiver is in TRANSMIT mode and the other is in RECEIVE mode.

- ☆ Always press the [ENT] key of the AR8000 in RECEIVE mode first so that it is ready to accept data.
- ☆ Press the [CLEAR] key of the receiver prior to the retry if the failure is due to incorrect connections or an error in key sequence.

6. An alternative method may be used to connect two AR8000 receivers for data CLONE. Two CU8232 interfaces may be employed with each AR8000 connected to the [PROGRAM] socket. The RS232 9-pin connectors are linked using a three wire crossed cable:

CU8232

Pin 2
Pin 3
Pin 5

CU8232

Pin 3
Pin 2
Pin 5

No other pins are used.

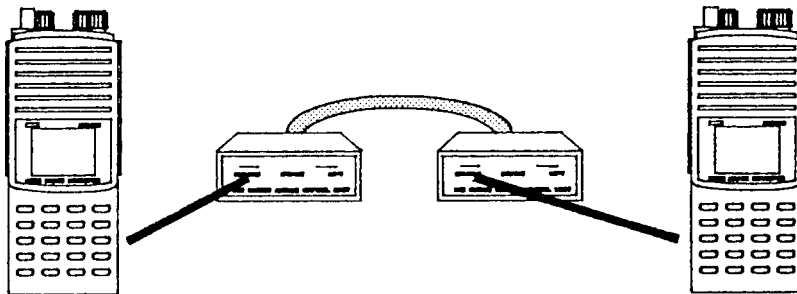

Figure 5

(4) Connection for RS232 operation

The remote facility enables the AR8000 to be operated via a computer such as an IBM-PC or similar, basic remote control terminal or dedicated software will be required to address the AR8000 through the CU8232.

Switching the receiver On/Off, setting of volume and adjustment of squelch cannot be achieved via the RS232 port.

Computers “always” generate RF noise which may interfere with the AR8000 reception if the standard helical rubber aerial is used. To reduce the effects of noise, use of a remote aerial is highly recommended with good quality 50 OHM coaxial cable employed.

Connect the AR8000 to the [PROGRAM] socket of the CU8232 as outlined earlier in section (3) and figure 1.

Connection to a computer is via the rear panel RS232C 9-pin "D" type female socket. Should you require a male socket then a 9-pin gender changer is supplied in the package. Should you prefer to use a 25-way "D" type female socket, an adaptor is also supplied as standard.

Always use a straight RS232 cable (null modem is not to be used!). The RS232 cable should be of good quality and no more than 2m in length. As the CU8232 is powered from the AR8000, excessive cable length may cause lost data between the AR8000 and computer.

Connection for an IBM-PC or clone is as follows:

CU8232 9-PIN	IBM-PC 9-PIN
2	2
3	3
5	5 (Ground)

All other pins not used but pins 4, 6 & 8 are linked together inside the CU8232. Some software requires the linking of CTS/RTS at the computer end of the cable (pins 7 & 8).

CU8232 9-PIN	IBM-PC 25-PIN
2	3
3	2
5	7 (Ground)

All other pins not used but pins 4, 6 & 8 are linked together inside the CU8232. Some software requires the linking of CTS/RTS at the computer end of the cable (pins 4 & 5).

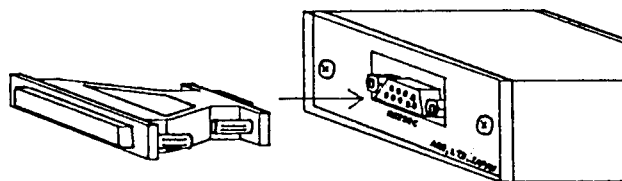

Figure 6

(5) Communication parameters

Communication between the AR8000 and computer (via the CU8232) uses semi-duplex. Refer to both the English language operating manual (page 101 section 18-1) and the computer handbook for correct settings.

Baud rate:	2400, 4800, 9600 selectable
Delimiter:	CR or CR,LF selectable
Stop bit:	2 BIT
Parity check:	None

The PC requires X-parameter flow control.

Both the computer and AR8000 must use the same parameters for correct operation.

If data is regularly lost or corrupted, try using a slower speed such as 4800 or 2400 baud. Use of a slower baud rate should not greatly reduce overall communications transfer rate since the processing time within the receiver and PLL lock-time ultimately restricts the whole process.

Note: When changing BAUD rate, switch the AR8000 Off/On to ensure the new speed is selected.

(6) Use of Microsoft WINDOWS “TERMINAL”

Assuming you have DOS and WINDOWS 3.1 (or later) loaded on an IBM-PC compatible computer, WINDOWS “TERMINAL” may be used to address the CU8232 and AR8000 receiver to enable basic remote operation.

Start WINDOWS by typing WIN at the DOS prompt. Locate the [TERMINAL] ICON in the program manager ACCESSORIES group and double-click.



Figure 7

If the terminal program has not be configured an error message will appear (depending upon the serial port / mouse configuration). Click on [OK] to continue.



Figure 8

TERMINAL will open and appear on the screen. You may re-size or maximise the screen at this point.

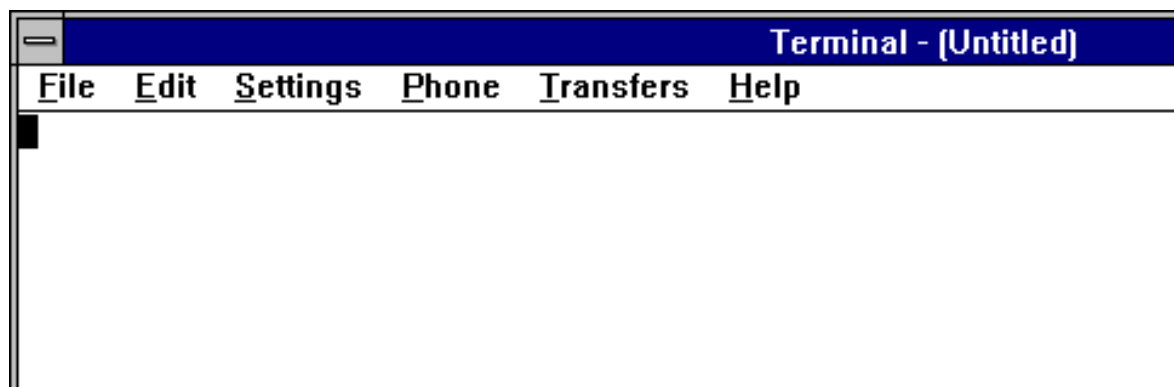

Figure 9

Click on the Settings heading toward the top of the screen so that the communications and terminal parameters may be configured. Click on "TERMINAL EMULATION" then select "ANSI" then click on [OK].

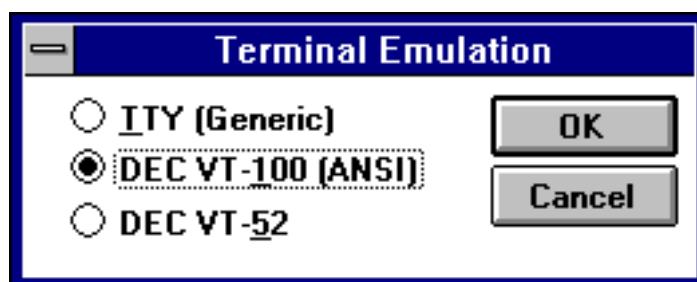

Figure 10

Click on the **S**ettings heading toward the top of the screen so that the communications and terminal parameters may be re-configured. Click on "TERMINAL PREFERENCES" then select the options as shown in figure 11. Finally click on [OK].

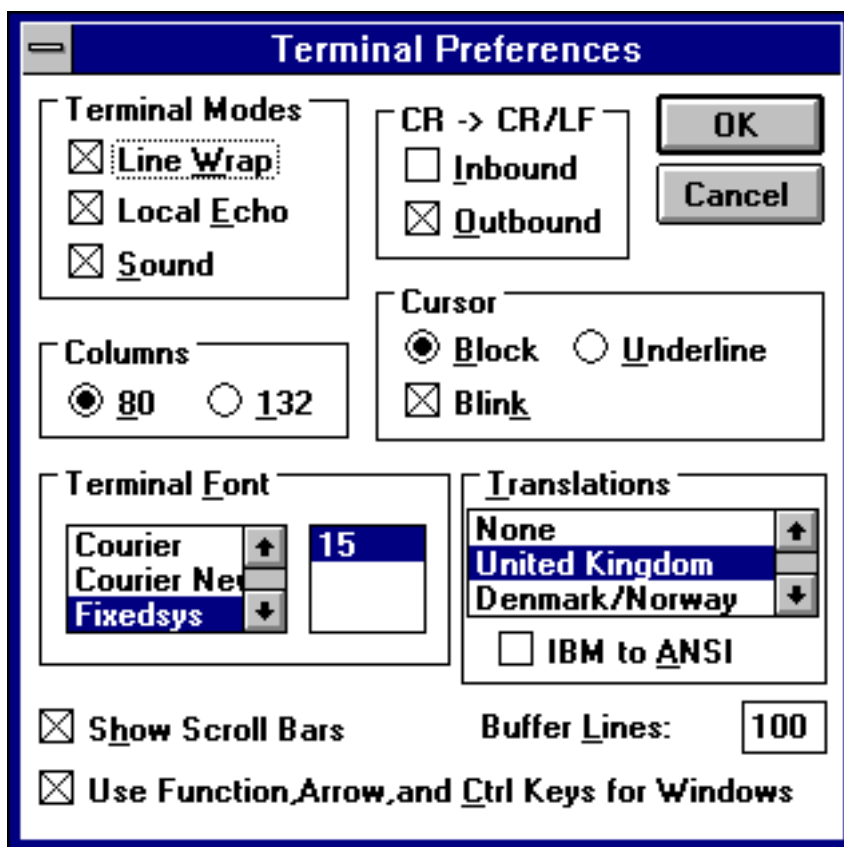

Figure 11

Click on the **S**ettings heading toward the top of the screen so that the communications and terminal parameters may be re-configured. Click on "COMMUNICATIONS" then select the options as shown in figure 12. The choice of COM port (COM1, COM2 etc) will depend upon your computer serial port and mouse configuration. Finally click on [OK].

Downloaded by RadioAmateur.EU

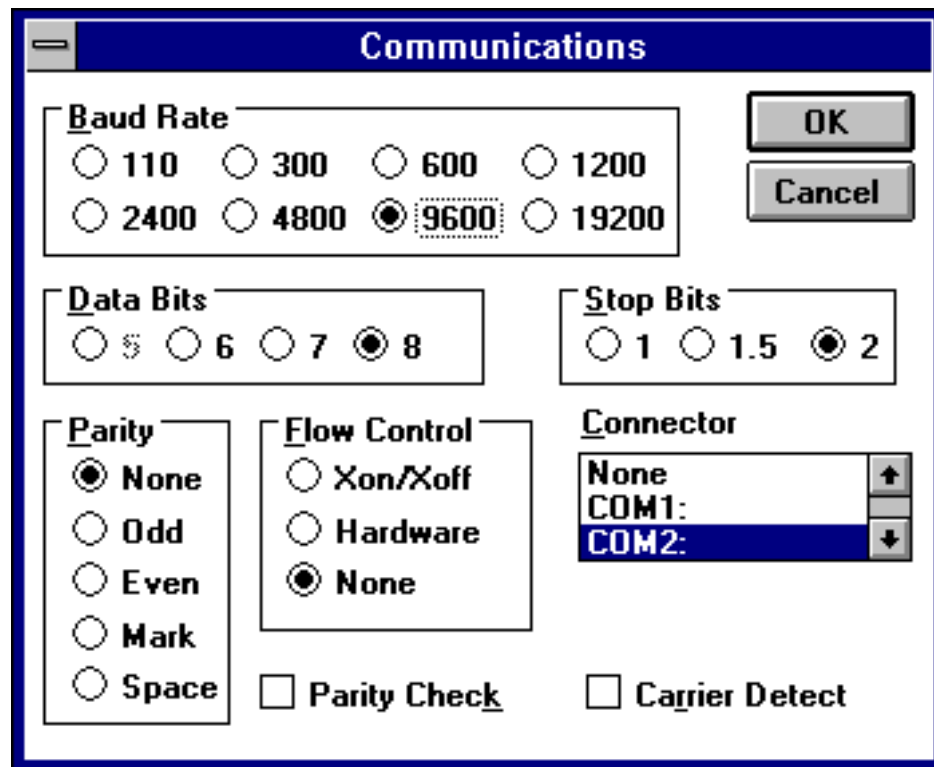

Figure 12

Finally click on the **F**ile heading toward the top of the screen and select **SAVE_AS**. This will enable the chosen parameters to be saved in a file which may be **OPENED** next time **TERMINAL** is selected so that the parameters will not require future re-configuration. Figure 13 shows a file name of **AR8000.TRM**, (.TRM being the default extension). The file is saved in the main **WINDOWS** sub directory.

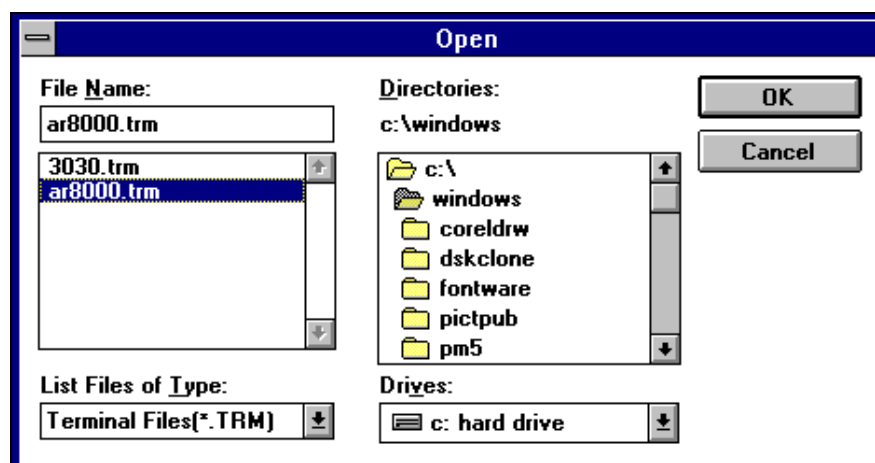

Figure 13

- ☆ For further information regarding WINDOWS TERMINAL and configuration, please refer to the operating manual supplied with Microsoft software and the computer.

Click on "COMMUNICATIONS" then select the options as shown in figure 11. The choice of COM port (COM1, COM2 etc) will depend upon your computer serial port and mouse configuration. Finally click on [OK].

(7) How to send a command

Each command comprises of two upper case letters (header) along with options as required. All commands use ASCII code which **MUST BE IN UPPER CASE** (except for the "ARROW" ↑ ↓ which uses the control code of ASCII).

A multiple command entry is only valid where specified. Where a multiple command entry is allowed, each command **MUST** be separated with a space "h20" (HEX DECIMAL).

Each command is completed with a [CR] or [CR],[LF] whichever is specified in the AR8000 receiver configuration (page 101 section 18-1 of the English language AR8000 operating manual), thereafter described as [↵].

Although there is no local echo, either [↵] or a specified response should come back from the receiver after confirming the correct command.

A space is often shown as "_" in the following examples.

REMOTE indication

When the AR8000 has received a command via the RS232C port the receiver's LCD will alternate between the top line of data and the wired "REMOTE". When remote mode is engaged the receiver's keypad becomes inoperative. To restore operation to the receiver's keypad press [LOCAL] - effectively remote operation is cancelled. Remote mode is re-engaged when a new command is received via the RS232C port.

The receiver always acknowledges the receipt of a command by sending [↵] (as specified in the receiver configuration) or will respond with the requested data. Only send a second command after the first command has gained a response.

If no response has been gained after a short while, the receiver has failed to receive the command properly. Send a [↵] then re-send the command. Should problems persist, check your serial / CU8232 connections and try reducing the RS232 baud rate.

(8) List of commands

Application	Command
VFO Freq Input	RF VA VB
Receiver Function	AT AU MC MD RX ST
SQ, S-Meter	LC LM MG SG
Receive Mode	DD MR MG MS SG SM SS VF
Search	BN BQ BS SA SB SD SE SG SO SP SQ SR SS
Search Data Write	AT AU MD SE SL SU ST TT
Pass Freq	PD PR PS PW
Memo CH, Scan	BM BN MA MG ML MP MQ MR MS XA XB XD XM XO XP XQ
Memo CH Data Write	AT AU MD MX RF ST TM
Select Scan	GA GD GR SM
Others	EX PA PI SC SI SN TI

↑[UP] (1E) ↓[DOWN] (1F) ()= Hex Decimal

Arrow is a control code of ASCII.

No delimiter is required when sending Arrow.

Commands which have dual roles are duplicated in this list.

(9) Command index

AT	Register the attenuator position ON/OFF.
AU	Register the auto mode ON/OFF.
BM	Register the scan bank link ON/OFF.
BN	Change the search/scan bank.
BQ	Register the search bank link function ON/OFF.
BS	Register the search bank link ON/OFF.
DD	Recall the VFO mode.
EX	End the Remote mode (RS232C).
GA	Register the select scan channel from Memory channel.
GD	Delete the select scan channel from Memory channel.
GR	Recall the select scan channel.
LC	Respond with the received freq and S-level when SQ opens.
LM	Respond with the S-level reading and SQ open/close.
MA	Respond with the contents of the present bank or specified bank.
MC	Select the monitor switch position.
MD	Select the receive mode.
MG	Start the scan mode. Respond with receive freq and S-level reading when SQ is open (as LC).
ML	Register the scan bank link function ON/OFF.
MP	Register the present memory channel as Pass channel.
MQ	Delete the present bank or memory channel.
MR	Switch to the memory read (M.RE) mode.
MS	Switch to the scan (SCAN) mode.
MX	Write data into memory channel.
PA	Register the delay time of Power Save mode.
PD	Delete the Search Pass Freq
PI	Register the interval time of Power Save mode.
PR	Recall the Search Pass Freq
PS	Register the Search Pass Freq
PW	Register the presently receiving freq as Pass Freq
RF	Key in the Freq in VFO
RX	Respond with the presently receiving data
SA	Register the Audio Search ON/OFF.
SB	Register the Level Search ON/OFF. Set the S-level.
SC	Change the operating code of the option unit (when fitted - not available in the UK).
SD	Change-over HOLD/DELAY in Search mode. Register the delay time.

SE	Register the Search data.
SG	Start the Search mode. Respond with freq and S-level reading when SQ is open.
SI	Switch the option unit ON/OFF (when fitted - not available in the UK).
SL	Write the start freq of Search.
SM	Start the Select Scan.
SN	Write the Pass Word. Recall the Pass Word.
SO	Recall the Search operating mode.
SP	Register the Free Search ON/OFF and delay time.
SQ	Check the SQ setting.
SR	Recall the Search data.
SS	Start the Search.
ST	Register the step size in search mode.
SU	Register the end freq of search mode.
TI	Register the interval time of Priority channel.
TM	Write the text for memory channel
TT	Write the text for search bank
VA	Initiate the AVFO mode.
VB	Initiate the BVFO mode.
VF	Initiate the 2VFO mode.
XA	Register the Audio Scan ON/OFF.
XB	Register the Level Scan ON/OFF.
XD	Register the delay time in Scan mode.
XM	Register the Mode Scan ON/OFF.
XO	Recall the Free Scan operating mode.
XP	Register the Free Scan ON/OFF and timing.
XQ	Recall the SQ operating mode.

Arrow Mark

↑[UP] ↓[DOWN] similar to the receiver's keyboard.

(10) Explanation of commands

AT

ATTENUATOR ON/OFF.

ATn[↵] n = 0 ATT OFF
 n = 1 ATT ON

Multiple commands in conjunction with other commands are possible with a space in between: AT, AU, MD, RF, ST, VA, VB.

Example: AU0_MD3_RF145.2_AT1[↵]

AT[↵] checks the current attenuator setting, the response being:

AT0 = ATT OFF
AT1 = ATT ON

Related commands MD MX RF SE VA VB

AU

AUTO MODE (and step) ON/OFF.

AUn[↵] n = 0 AUTO MODE OFF
 n = 1 AUTO MODE ON

Multiple commands in conjunction with other commands are possible with a space in between: AT, AU, MD, RF, ST, VA, VB.

Example: AU0_MD3_RF145.2[↵]

AU[↵] checks the current auto mode setting, this is not valid when "M.RE" or "SCAN" is in use. The usual response to the AU request being:

AU0 = AUTO MODE OFF
AU1 = AUTO MODE ON - step size and receive mode set automatically.

Related commands MD MX RF SE ST VA VB

BM

SCAN BANK LINK ON/OFF (specifically).

BM[↵] checks the current status of linked scan banks.

If bank letters are specified then scan bank link is On (the specified banks will be scanned as a group), if no letters are specified then the facility is Off.

First check the current status by typing BM[↵]

A typical response may be: BM -BC—GHIJa—e—h-j

To switch bank link Off type in the reported scan bank letters:

BM BCGHIJaehj (lower case input being accepted for the second group of memory banks)

To activate a new scan bank link type in the required list of scan bank letters. For example to link a few specified scan banks and turn the facility On:

Type BM followed by the bank letters and terminated with [↵]

BM ABDabcij [↵]

The BM command may be used to switch some banks On and others Off at the same time. To make things easier a “-” character **reverses** the current status of the specified bank, of course this may also be used to switch scan bank link Off.

Note: The SCAN BANK LINK facility can also be simply switched On/Off using the ML command.

BS is the equivalent command for SEARCH bank link.

Related commands ML BN XA XB XD XM XO XP XQ

To activate a new search bank link type in the required list of search bank letters.
For example to link a few specified search banks and turn the facility On:

Type BS followed by the bank letters and terminated with [↵]

BS ABDabcij [↵]

The BS command may be used to switch some banks On and others Off at the same time. To make things easier a "-" character **reverses** the current status of the specified bank, of course this may also be used to switch search bank link Off.

Note: The SEARCH BANK LINK facility can also be simply switched On/Off using the BQ command.

BM is the equivalent command for SCAN bank link.

Related commands BQ SA SB SD SG SO SP SS

DD

Report the current VFO data.

Type DD[↵] to report the current VFO data.

Should a response be as follows:

RF0001134000_ST009000_AU1_MD2_AT0 the data breakdown is:

Receive frequency:	1.134 MHz
Step size:	9.0 kHz
Auto mode:	ON
Receive mode:	AM
Attenuator:	OFF

Related commands MR MG MS RX SG SM SS VF [UP] [DOWN]

EX

End remote operation and restore keypad operation to AR8000.

To end RS232 remote operation type EX[↵]

This has the same effect as pressing the [LOCAL] key on the AR8000 receiver.

GA

Designate (“TAG”) memory channel for select scan.

The GA command is used to “tag” memory channels for select scan.

GAnn[↵] where x is the bank letter A-J & a-j
 where nn is the memory channel number 00-49

Related commands GD GR SM

GD

Deactivate (“UN-TAG”) memory channel for select scan.

The GD command is used to remove “tags” from memory channels and remove the frequency from the select scan list.

GDnn[↵] where nn is the select scan channel number 00-49

For example, to clear select scan channel 03 type GD03[↵]

When a select scan channel has been deleted, the registered memory channel number will automatically be updated. Use the GR command to check the updated registered channel number.

To clear all select scan channels in one go type GD%%[↵]

Related commands GA GR SM

GR

Recall select scan channels.

The GR command is used to recall the data from select channels specifically or as a whole.

Select scan channels are assigned in order 00 - 99. When a select scan channel is deleted the higher numeric channel “shuffle down” to fill the vacant allocation (refer to page 69 section 11 of the English language operating manual for further information).

To recall the data from a specific select scan channel use the format:

GRnn[↵] where nn is the channel number 00 - 99

To recall the data from all select scan channels type GR[↵]

The response for a specific channel may look like this:

```
GR01_MXB07_MP0_RF0126000000 ST025000_MD2_AT0_TMTEST123
```

The information reported being:

Select scan:	Channel 01 (second registered channel)
Memory bank:	B
Memory channel:	07
Memory pass:	OFF
Receive Frequency:	126.00 MHz
Receive mode:	AM
Attenuator:	OFF
Displayed text:	TEST123

Related commands GA GS GR SM

LC

The LC command caused the receiver to supply FREQUENCY and S-METER level only when the squelch is opened. A new response will be repeated automatically when the squelch is closed and opened again.

The automatic data response will only be supplied when ALL squelch parameters are met (level scan, audio scan etc).

To terminate the facility send another command.

LC[⇐] will report the present receive frequency and S-meter. The S-meter report is in 64 steps from hex decimal 00 to 3F.

A typical response may be: LC1B_RF0145300000

1VFO S-meter h1B Receive frequency 145.30 MHz

Another example: LC04_VA0128800000

2VFO VFOA S-meter h04 Receive frequency 128.80 MHz

Notes: S-meter reading and frequency are separated with a space. The S-meter output is in 64 steps (hex decimal) 00 to 3F. "3F" may not be available on some sets as the CPU processes the data and the MAXIMUM level may vary slightly between sets.

Approximate relation of S-meter and LC report:

S-meter	0	1	2	3	4	5	6	7
"LC"	0 ~ 04	~ 08	~ 0C	~ 10	~ 14	~ 18	~ 1C	~ 3F (16 hex)

Related commands LM MG SG

LM

S-meter reading and squelch status.

The LM command is used to report the S-meter level and squelch open / closed status.

The S-meter reading is reported in 64 steps (hex) 00 ~ 3F. The squelch is CLOSED when the response is 80 and above.

A typical response to the LM[↔] command is: LM1D

00 ~ 3F	Squelch is open
80 ~ BF	Squelch is closed

Related commands LC MG SG [UP] [DOWN]

MA

Recall data from the current of specified memory bank.

The MR command recalls data from the current of specified memory bank.

MR[↔] recalls data from the current memory bank.

MRx[↔] recalls data from the specified memory bank where

x = A ~ j & a ~ j.

A typical response being:

```
MXA00_MP0_RF0000945000_ST009000_AU1_MD2_AT0_TMGEAM
MXA01_MP0_RF0000693000_ST009000_AU1_MD1_AT0_TMRadio 5
```

SIMILAR FORMAT FOR ALL CHANNELS...

```
MXA49_MP0_RF0082520000_ST100000_AU1_MD1_AT0_TMJOAK-FM
```

The first memory channel data being:

Memory bank:	A
Memory channel:	00
Memory pass:	OFF
Receive frequency:	945 kHz (0.945 MHz)
Step increment:	9 kHz
Auto mode:	ON
Receive mode:	AM
Attenuator:	OFF
Displayed text:	GEM AM

If no data is available in the selected or current memory bank the response may look like this:

```
MXD_— No memory data in this channel of bank "D".
```

Related command MX

MC

Select monitor switch position.

The monitor switch may be selected irrespective of squelch setting by use of the MC command. This is particularly useful for weak or fluttery signal monitoring or when listening to SSB transmissions. The MC command may also be used to mute the audio completely.

MCn[↵] where n = 0 MUTE OFF (emit audio)
 n = 1 MUTE ON (mute audio)
 n = 2 MUTE AUTO (restore normal SQ operation)

MD

The MD command provides a quick method to report and change the current receive mode without affecting other settings.

To report the current mode type:

MD[↵] where 0 = WFM
 1 = NFM
 2 = A M
 3 = USB
 4 = LSB
 5 = C W

To change the current mode:

MDn[↵] where n equals 0 ~ 5

MD0[↵]	WFM
MD1[↵]	NFM
MD2[↵]	A M
MD3[↵]	USB
MD4[↵]	LSB
MD5[↵]	C W

Multiple command entry is of course possible: AT0_MD3_RF145.2[↵]

Related commands AU MX RF SE VA VB

MG

Scan with frequency and S-meter then resume.

The MG commands causes an automatic response of receive frequency and S-meter level (similar to LC command) AND places the receiver into memory scan mode again.

MG[↔] will report the present receive frequency in Hz and S-meter. The S-meter report is in 64 steps from hex decimal 00 to 3F.

A typical response may be: LC2B_RF0145300000

S-meter h2B Receive frequency 145.30 MHz

Related commands BM BN DD ML MP MQ MR MS MX SG SS VF XA VB XD XM
XO XP XQ ↑ ↓

ML

Scan bank link On/Off.

The ML command is used to switch the memory scan bank link facility ON / Off.

The command ML[↔] may be used to check the current status of scan bank link.

To change the status of scan bank link, the MLn[↔] command is used

where n = 0 Bank link OFF
 n = 1 Bank link ON

Related commands BM BN XA XB XD XM XO XP XQ

MP

Register the present channel as PASS.

The MP command is used to register the current memory channel as PASS (so that it will be skipped during scan). The command is generally used in conjunction with the "MR" command.

To check the current status of PASS use the command MP[↵]

The response will be	MP0	Memory PASS OFF
	MP1	Memory PASS ON

It is possible to change the status of memory channel PASS using the command:

MPn[↵] where n = 0 Channel PASS OFF
n = 1 Channel PASS ON

Related commands BN MQ MR MG MS

MQ

Delete the current memory channel OR bank.

The MQ command **can only be used in M.RE (memory read) mode**. It is used to delete memory channels or a whole memory bank in one go. The memory bank must first be recalled as the active bank.

Note: One memory channels have been deleted the data is lost. They can not be reinstated but new data has to be written to the channel if required.

The command MQ[↵] deleted the current memory channel.

The command MQnn[↵] deletes the specified memory channel from the current bank were nn = 00 ~ 49

The command MQ%%[↵] deletes ALL memory channels from the current memory bank.

Related commands BN MP MR MG MS

MR

Place the receiver in M.RE - memory read mode.

The MR command is used to place the receiver into memory read mode. The MR command is also required before channels may be deleted using the MQ command.

The MR[⇐] command places the receiver in memory recall mode and the last used channel data is reported.

It is possible to specify both the memory bank and channel number for recall:

MRxnn[⇐] where x = memory bank A ~ J & a ~ j
 nn = channel number 00 ~ 49

A typical response to the MR command may be:

MAC43_RF0435120000_ST20000_MD1_AT0_TMBANKC43

Memory bank:	C
Memory channel:	43
Receive frequency:	435.12 MHz
Step size:	20 kHz
Receive mode:	NFM
Attenuator:	OFF
Text:	BANKC43

A response of: MAD00_— indicates that the memory bank has no channels programmed or they have been deleted.

Related command MA

MS

Start memory scan.

The MS command places the receiver into memory scan mode.

MS[↵]

Commences memory scan from the current memory bank (or last one used if in another operating mode).

MSx[↵]

Commences memory scan from a specified memory bank number

where x = A ~ J & a ~ j memory bank number

Related commands BM BN DD MG ML MP MQ MR MX SG SS VF XA VB XD XM
XO XP XQ ↑ ↓

MX

Write data into a memory channel.

The MX command is used to write a comprehensive set of data to a specified memory bank / channel.

The format of the command is:

MXxnnRF[freq]_AU[auto mode]_ST[step size]_MD[mode]_AT[att]_TM[text] [↵]

For example: MXD12_RF124.8_AU1_AT0_TMAirband [↵]

This will set memory bank “D” channel “12” to 124.8 MHz, Auto mode ON, Attenuator OFF and text “Airband”.

Always start with MX and end with TM followed by [↵]. Each command is separated with a space _ .

MXxnn Memory location where

x = A ~ J & a ~ j memory bank
nn = 00 ~ 49 memory channel

RFnnnnnnnm0 (Hz)

Frequency input frequency in Hz. The last but one digit (tens of Hz) MUST be either “5” or “0”.

PA

Set delay time for power save mode.

The PA command is used to set the delay time and is used in conjunction with PI which sets the interval time for the power save facility.

The command PA[↵] checks the current setting of power save delay time, the response being PAnn where

nn = 01 ~ 99 seconds
nn = 00 is power save OFF

To change the current setting, use the PA command followed by a two digit numeric value between 00 ~ 99. The value is in seconds and "00" switched the power save facility off (please refer to page 97 section 16 of the AR8000 English language operating manual).

To set a delay of 12 seconds use the command PA12[↵]

Related command PI

PD

Delete PASS frequencies in search mode.

There are 50 PASS frequencies allocated per search bank, they may be deleted on an individual basis or the whole bank may be deleted in one go.

The BN or SS commands must be used to choose the bank prior to using the PD command.

PDnn[↵] deletes a specific PASS frequency from the chosen search bank where nn is the PASS channel number 00 ~ 49.

When a PASS channel is deleted, the PASS frequency number will be incremented upward.

PD%%[↵] deletes ALL PASS channels from the current search bank in one go.

Related commands BN PR PS PW SG SR SS

PI

Set interval time for power save mode.

The PI command is used to set the interval time and is used in conjunction with PA which sets the delay time for the power save facility.

The command PI[↵] checks the current setting of power save delay time, the response being PIn where n = 1 ~ 9 seconds

To change the current setting, use the PI command followed by a single digit numeric value between 1 ~ 9, the value is in seconds.

To set an interval of 5 seconds use the command PI5[↵]

(Please refer to page 97 section 16 of the AR8000 English language operating manual).

Related command PA

PR

There are 50 PASS frequencies allocated per search bank, they may be recalled on an individual basis for review using the PR command before being deleted using the PD command.

The BN or SS commands must be used to choose the bank prior to using the PD command.

PRnn[↵] recalls a specific PASS frequency from the chosen search bank where nn is the PASS channel number 00 ~ 49.

When a PASS channel is deleted using the PD command, the PASS frequency number will be incremented upward.

Related commands BN PD PS PW SG SR SS

PS

Write search PASS frequency.

There are 50 PASS frequencies allocated per search bank, they may be entered using the PS command. The BN or SS commands must be used to choose the bank prior to using the PS command.

PSnnnnnnnn00[↵] (Hz)	enter PASS frequency in Hz
PSnnnn.nnn[↵] (MHz)	enter PASS frequency in MHz. If MHz entry is used there is no need to enter the trailing digits after the decimal point, they will be treated as "0".

Examples of PASS frequency input:

150.2 MHz	PS150.2[↵] or PS150200000[↵]
1134 kHz	PS1.134[↵] or PS1134000[↵]
1691.0 MHz	PS1691.[↵] or PS1691000000[↵]

Related commands BN PD PR PS SG SS

PW

Register current frequency as PASS.

The PW command is used to register the current receive frequency in the search pass list. The BN or SS commands must be used to choose the bank prior to using the PW command.

The command PW[↵] being used.

Related commands BN PD PR PS SG SS

RF

Write and recall receive frequency to / from VFO.

The RF command is used to write a frequency to VFO. The input may be specified in Hz or in MHz if the decimal point is used.

The format of the RF command being:

```
RFnnnnnnnnm0[↵]      (Hz)
or
RFnnnn.nnnnm[↵]      (MHz)
```

Note: "0" must always be used in the 1Hz place when using Hz input & "m" must always be either 0 or 5 in the 10Hz position, any other number will be ignored. Frequencies below 1.6 MHz (1600 kHz) are displayed as kHz.

For example:

```
150.3 MHz  input      RF150.2[↵] or RF150200000[↵]
1134 kHz   input      RF1.134[↵] or RF1134000[↵]
1691.0 MHz input      RF1691.[↵] or RF1691000000[↵]
```

To recall the receive frequency of the current VFO, the RF[↵] command is used. The response may look like RF0001134000[↵]

Related commands VA VB

RX

Recall present operating condition and data.

The RX command is used to recall (generate a report) the current operating condition of the receiver including VFO, SCAN, SEARCH etc along with receive mode, frequency etc.

The format of the RX command is: RX[⇐]

A two letter code reports the current operating condition with further details (receiver frequency etc) following as appropriate. The meaning of the two letter code is as follows:

DD. .	VFO	MODE
VF. .	2 VFO	MODE
MR. .	MEMO CH	MODE
MS. .	SCAN	MODE
SM. .	SELECT SCAN	MODE
SS. .	SEARCH	MODE

Response examples are as follows:

```
VFO MODE      DD_RF012600000)ST025000_MD2_AT0
2VFO MODE     VF_VA0128680000_ST025000_MD2_AT0
MEMO CH MODE (M.RE) MR_MXB07_MP0_RF012600000_ST025000_MD2_AT0_TMTTest123
SCAN MODE     MS_MXB17_MP0_RF0197750000_ST025000_MD0_AT0_TMTV-8ch
SELECT SCAN MODE SM_MXA34_MP0_RF0028500000_ST000050_MD3_AT0_TM28m_HAM
SEARCH MODE   SS_RF0128800000_ST025000_AU1_MD2_AT0_TTAIR.VHF
```

Related command BN

SA

Audio search ON/OFF.

The SA command is used to report the current setting of audio search and to change the setting between On and Off.

To recall the current setting type SA[⇐]

The response will be SAn where:

n = 0	Audio search OFF
n = 1	Audio search ON

SC

Set operating code for option (not available in the UK).

The SC command is used to review and select the operating code if the option is fitted to the AR8000. LSB is used to control the optional unit.

To review the current selection of code use the command SC[↵]

The response will be in the format SCnn where nn = 00 ~ 7F (HEX DECIMAL)
Some units may only have four operating codes, in this case the lower end of 2BIT is used. They are identical in operation: 01 05 09 0D 25 39 5D 79

To change the current code use the format SCnn[↵] where nn is the desired operating code.

Related command SI

SD

Change HOLD / DELAY time in search mode.

The SD command is used to review and change the setting of HOLD / DELAY time when in search mode.

To review the current setting use the command SD[↵]

The response will be in the format:

SDnn where nn = 01 ~ 99 DELAY in tenths of seconds (100mS)
nn = FF HOLD
nn = 00 DELAY OFF

Examples are: SD65 = DELAY of 6.5 seconds
SD52 = DELAY of 5.2 seconds
SDFF = HOLD ON
SD00 = DELAY OFF

To change the current setting of HOLD / DELAY in search mode use the format SDnn[↵] where: nn = 01 ~ 99 DELAY in tenths of seconds (100mS)
nn = FF HOLD
nn = 00 DELAY OFF

Related commands BQ BS SA SB SG SO SP SQ

SE

The SE command is used to input data for search bands.

To write search data into the currently selected search bank, the format of the SE command is:

```
SE_SL[LOWER FREQUENCY]_SU[HIGHER FREQUENCY]_AU[AUTOMODE]_
ST[STEP SIZE]_MD[MODE]_AT[ATTENUATOR]_TT[TEXT][↵]
```

To write search data to a specific search bank, the following format is used:

```
SEx_SL[LOWER FREQUENCY]_SU[HIGHER FREQUENCY]_AU[AUTOMODE]_
ST[STEP SIZE]_MD[MODE]_AT[ATTENUATOR]_TT[TEXT][↵]
```

Where:

SE_x	x = Search bank number A ~ J or a ~ j
SL	Lower frequency limit nnnnnnnm0 (Hz) or nnnn.nnnnm (MHz) m = "0" or "5" (tens of Hz position)
SU	Upper frequency limit nnnnnnnm0 (Hz) or nnnn.nnnnm (MHz) m = "0" or "5" (tens of Hz position)
AU	Automode n = 0 Automode OFF n = 1 Automode ON When automode is ON, the receive mode and step size is automatically set and any alternative input of SE will be ignored. Refer to AU command.
ST	Step size nnnnm0 (Hz) or nnn.nm (kHz) m = "0" or "5" (tens of Hz position)
MD	Receive mode WFM 0 NFM 1 AM 2 USB 3 LSB 4 CW 5
AT	Attenuator n = 0 Attenuator OFF n = 1 Attenuator ON
TT	Text comment - Up to 7 ASCII characters or characters available in the list (see list under "TT" command and further detail under TM command)

A typical input may look like:

```
SEC_SL0118500000_SU0135900000_AU1_(ST025000_MD2_)AT0_TTAIR.VHF[↵]
```

The input in brackets () is ignored when automode is selected ON.

Related commands SR SG SS

SG

Search with frequency and S-meter then resume.

The SG commands causes an automatic response of receive frequency and S-meter level (similar to MG / LC command) AND places the receiver into search mode again.

SG[↵] will report the present receive frequency in Hz and S-meter. The S-meter report is in 64 steps from hex decimal 00 to 3F starting from the currently selected search bank.

A typical response may be: LC2B_RF0145300000

S-meter h2B Receive frequency 145.30 MHz

The command SGx[↵] causes an automatic response and searching from the specified bank where x = A ~ J & a ~ j.

Related commands LC MG SS ↑ ↓

SI

Set code for option ON / OFF (not available in the UK).

The SI command is used to review and select the optional code unit On / Off if the option is fitted to the AR8000.

To review the current status use the command SI[↵]

The response will be in the format SIn

where

n = 0 Optional code unit OFF

n = 1 Optional code unit ON

To switch the code option ON / OFF use the format SIn[↵]

where

SI0[↵] = Optional code unit OFF

SI1[↵] = Optional code unit ON

Related command SC

SO

Check the search options (delay, free & hold).

The SO command is used to check the current setting of search parameters.

Use the command SO[↵]

The response will be

SO0	=	DELAY MODE ON
SO1	=	FREE MODE ON
SO2	=	HOLD MODE ON

Related commands SA SB SD SP SQ BS BQ

SP

Free search mode On / Off.

The SP command is used to review and set the parameters of free search mode including timing.

To review the current parameters use the format SP[↵]

The response will be SPnn where

nn	=	01 ~ 99 seconds free search time
nn	=	00 free search OFF

For example SP15 would represent free search ON and timing is 15 seconds.

To change the current setting of free search mode use the format SPnn[↵]

where

nn	=	01 ~ 99 seconds free search time
nn	=	00 free search OFF

For example SP52[↵] would switch free search mode ON with a timing of 52 seconds.

Related commands SA SB SD SO SQ BS BQ

SQ

Check the search options (level & audio).

The SO command is used to check the current setting of search parameters.

Use the command SQ[↵]

The response will be

SQ0 =	Not engaged
SQ1 =	Level search ON
SQ2 =	Audio search ON
SQ3 =	BOTH level & audio search ON

Related commands SA SB SD SO SP BS BQ

SR

Recall search data.

The SR command is used to recall search data for a chosen bank.

To recall the search data from the currently selected search bank use the format SR[↵]

To recall the search data from a specific bank use the format SRx[↵]

where

x = search bank A ~ J or a ~ j.

A typical response may be:

SRC_SL0118500000_SU0135900000_ST025000_AU1_MD2_AT0_TTAIR.VHF

This is a data breakdown of:

Search bank	C
Lower (start) frequency	118.50 MHz
Upper (end) frequency	135.90 MHz
Automode	ON (this means that mode & step are ignored so do not have to be specified as will be taken from the receivers preprogrammed data)
Attenuator	OFF
Text	AIR.VHF

Related command SE

SS

Engage search mode - start search.

The SS command is used to start the search process from either the current or specified search bank.

To start searching from the current search bank use the format SS[↵]

To start searching from a specified search bank use the format SSx[↵]

where

x = search bank A ~ J or a ~ j.

Related commands DD MR MS RX SG VF ↑ ↓

ST

Tuning step size.

The ST command is used in conjunction with several other commands to set the tuning or search increment. Multiple command entry is possible with AT, AU, MD, RF, ST, VA & VB (with a space separating each command).

The format of the command is ST nnnnm0[↵] (Hz)
or
ST nnn.nm[↵] (kHz)

m = "0" or "5" (tens of Hz position), "0" must always be zero - any other entry will be ignored. Any step size is possible in multiples of 50 Hz up to 999.995 kHz.

Note: When step size is entered AUTOMODE is automatically switched OFF.

To view the current setting of step size use the command ST[↵]

A typical response may be ST020000 which would be 20 kHz.

A typical multiple command may be AU0_MD3_RF145.2_ST010.[↵]

Related commands AU MD MX RF SE VA VB

TM

Write text in conjunction with memory channel.

The TM command cannot be used on its' own but is used in conjunction with the MX command to write text comments into a memory channel. Up to 7 ASCII characters or characters from the table (below) may be entered. Blank table entries [] represent a blank space. Please refer to the MX command for full details of use.

TMxxxxxxx Text write where xxxxxxx may be up to 7 characters in ASCII or character mode.
Entry is completed with a [↵]

		LOWER DIGIT HEX DECIMAL															
		0	1	2	3	4	5	6	7	8	9	A	B	C	D	E	F
HIGHER DIGIT	2	□	!	"	#	\$	%	&	'	()	*	+	,	-	.	/
	3	0	1	2	3	4	5	6	7	8	9	:	;	<	=	>	?
	4	0	A	B	C	D	E	F	G	H	I	J	K	L	M	N	O
	5	P	Q	R	S	T	U	V	W	X	Y	Z	[]	^	_	~
	6	/	a	b	c	d	e	f	g	h	i	j	k	l	m	n	o
	7	p	q	r	s	t	u	v	w	x	y	z	{		}	+	=
	A	□	。	「	レ	、	・	ヲ	マ	メ	カ	キ	ク	ケ	コ	サ	シ
	B	ー	ア	イ	ウ	エ	オ	カ	キ	ク	ケ	コ	サ	シ	ス	セ	ソ
	C	0	1	2	3	4	5	6	7	8	9	A	B	C	D	E	F
	D	0	1	2	3	4	5	6	7	8	9	A	B	C	D	E	F
	E	0	1	2	3	4	5	6	7	8	9	A	B	C	D	E	F
	F	0	1	2	3	4	5	6	7	8	9	A	B	C	D	E	F

Related commands MR MX

TT

Write text in conjunction with a search bank.

The TT command cannot be used on its' own but is used in conjunction with the SE command to write text comments into a search bank. Up to 7 ASCII

characters or characters from the table (see TM) may be entered. Blank table entries [] represent a blank space.

TTxxxxxxx Text write where xxxxxxx may be up to 7 characters in ASCII or character mode. Entry is completed with a [↵]

Related commands SE SR

VA VB

Check and change the receive frequency of VFOA or VFOB.

The VA and VB commands may be used to read the current frequency from VFOA or VFOB and to write a new receive frequency. **Both commands are used in the same manner, VA addressing VFOA and VB addressing VFOB.**

To read the current receive frequency of VFO A use the format VA[↵]

A typical response may be:

VA0001134000_ST009000_AU1_MD2_AT0

2VFO MODE VFO A, receive frequency 1.134 MHz, channel step size 9 kHz, automode ON, receive mode AM, attenuator OFF.

To read the current receive frequency of VFO B use the format VB[↵]

A typical response may be:

VB0145040000_ST020000_AU1_MD1_AT0

To write a new frequency to VFO A and switch to 2VFO mode use the format:

VAnnnnnnnnm0 (Hz)
VA nnnn.nnnnm (MHz)

where m = "0" or "5" in the 10Hz position. "0" in the Hz position is always "0", any other value will be ignored. Frequencies below 1.6 MHz are displayed as kHz.

A typical input to write a new frequency of 433.250 MHz to VFO B would be:

VB433.25[↵]

Multiple command entry is possible (using AT, AU, MD, RF, ST) with a space separating each command: AU0_MD3_VB433.2[↵]

Related commands AT AU MD RF ST VA VB

VF

Switch to 2VFO mode.

The VF command is used to place the receiver into 2VFO mode. The data from the current VFO (A or B) is automatically reported.

Use the command VF[↔]

A typical response may be: VA0433040000_ST0200000_AU1_MD1_AT0

The data representing 2VFO mode, VFOA active, receive frequency 433.04 MHz, 20 kHz channel step, Automode ON, receive mode NFM, attenuator ON.

Another response may be (for VFOB): VB0145080000_ST0200000_AU1_MD1_AT0

Related commands DD MR MG MS SM SG SS VA VB

XA

Audio scan ON / OFF.

The XA command is used to check the current setting of audio scan mode and change the status as required.

To check the current status use the format XA[↔]

The response will be XA0 = audio scan OFF
 XA1 = audio scan ON

To change the status of audio scan ON / OFF use the format:

 XAn[↔] where n = 0 audio scan OFF
 n = 1 audio scan ON

Related commands BM ML XB XD XM XO XP XQ

XB

Level scan ON / OFF.

The XB command is used to check the current setting of level scan mode and change the status as required.

To check the current status use the format XB[↵]

The response will be XB0 = level scan OFF
 XB1 ~ XB7 = level scan ON

To change the status of level scan ON / OFF use the format:

 XBn[↵] where n = 0 level scan OFF
 n = 1 ~ 7 level scan ON
 for example SB3 means level scan set to
 threshold 3

Related commands BM ML XA XD XM XO XP XQ

XD

Scan delay time.

The XD command is used to check and set the scan delay time.

To check the current setting use the format: XD[↵]

The response will be XDnn where nn = time incremented in tenths of seconds (100mS), the value of nn is between 00 ~ 9.9 When nn = 00 scan delay is OFF.

For example a response of XD5.2 would indicate scan delay time is set to 5.2 seconds while a response of XD00 indicates that scan delay is OFF.

To change the setting of scan delay time use the format:

 XDnn[↵] where nn = 00 ~ 9.9

The value being incremented in tenths of seconds (100mS) and 00 being scan delay OFF.

Related commands BM ML XA XB XM XO XP XQ

XM

Mode scan.

The XM command is used to check and set the options for MODE SCAN.

To check the current setting use the format: XM[↵]

The response will be:

XM0	=	WFM
XM1	=	NFM
XM2	=	A M
XM3	=	USB
XM4	=	LSB
XM5	=	C W
XMF	=	ALL MODE (effectively scan mode off)

To change the setting of mode scan use the format: XMn[↵]

where:

n = 0	WFM
n = 1	NFM
n = 2	A M
n = 3	USB
n = 4	LSB
n = 5	C W
n = F	OFF - ALL MODES will be scanned.

Related commands BM ML XA XB XD XO XP XQ

XO

Free scan ON / OFF.

The XO command is used to check the current setting of free scan mode.

To check the current status use the format XA[↵]

The response will be

XO0	=	free scan OFF
XO1	=	free scan ON

Related commands BM ML XA XB XD XM XO XP XQ

XP

Change free scan time in scan mode.

The XP command is used to review and change the setting of free scan time when in scan mode.

To review the current setting use the command XP[↵]

The response will be in the format:

XPnn where nn = 01 ~ 99 free scan time in seconds
nn = 00 free scan mode OFF

Examples are: XP52 = free scan time of 52 seconds
 XP00 = free scan mode OFF

To change the current setting of free scan mode use the format XPnn[↵]

where: nn = 01 ~ 99 free scan time in seconds
 nn = 00 free scan mode OFF

For example, an input of XP15[↵] would activate free scan mode with a delay time of 15 seconds.

Related commands BM ML XA XB XD XM XO XQ

XQ

Check the scan options (level & audio).

The XQ command is used to check the current setting of scan parameters.

Use the command XQ[↵]

The response will be XQ0 = Not engaged
 XQ1 = Level scan ON
 XQ2 = Audio scan ON
 SQ3 = BOTH level & audio scan ON

Related commands BM ML XA XB XD XM XO XP



UP / DOWN arrows.

The arrow commands have largely the same effect as the arrow keys on the front panel of the AR8000 receiver. In VFO mode the frequency is incremented upward or downward, in memory recall mode the next channel is selected and in search/scan modes the direction of search/scan may be reversed.

The value for is "h1E" (HEX DECIMAL) and the command may be sent using the format [↵]

The value for is "h1F" (HEX DECIMAL) and the command may be sent using the format [↵]

Related commands DD MG MS SM SS VA VB VF

** IBM PC compatible specialist software for the AR8000-CU8232 & Microsoft WINDOWS will be available soon*

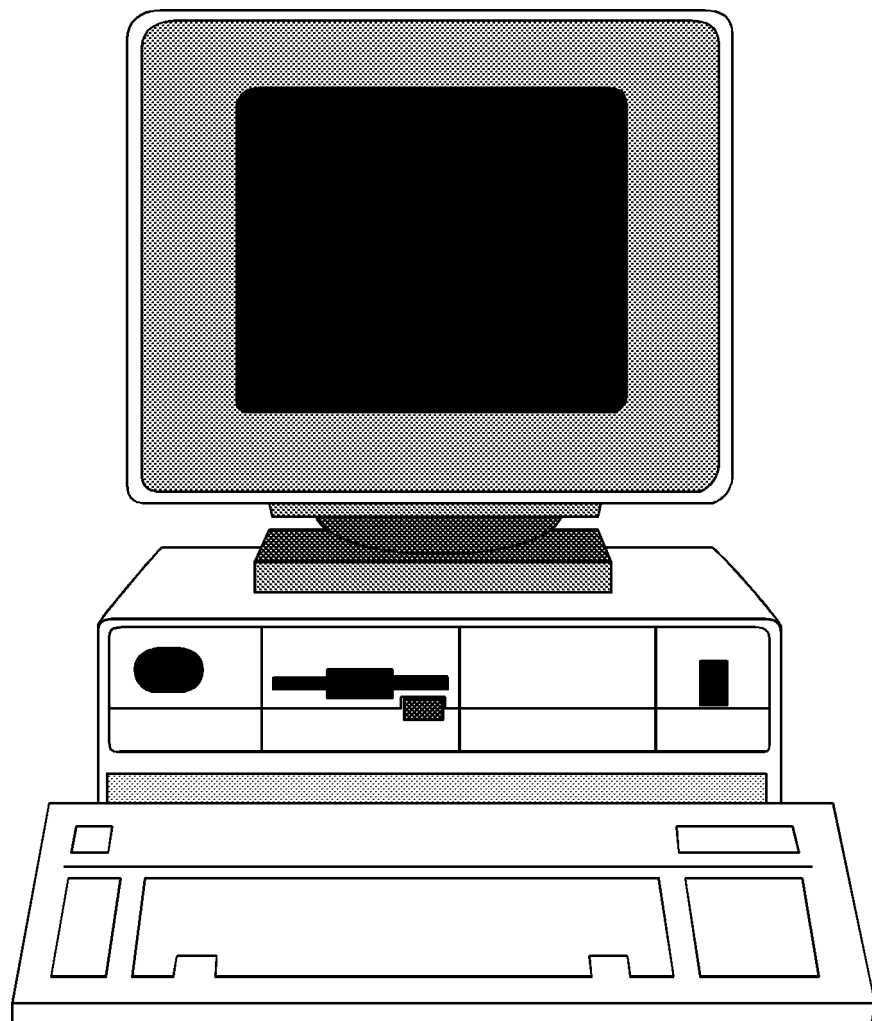



AOR, LTD

2-4-6 Misuji, Taito-ku, Tokyo 111, Japan
TEL (03) 3865 1681

Downloaded by
RadioAmateur.EU