

NEC-2 Manual, Part III: User's Guide

Microsoft Word/Macintosh 5.1a formatted binary document (WDBN) version,
including all Figures, ready for printing, and incorporating many corrections, of the html version of the NEC-2 Manual at
<<http://www.traveller.com/~richesop/nec/>>

Table of Contents

Section	Page
LIST OF ILLUSTRATIONS	3
Preface	4
Disclaimer for the Web and Microsoft Word Versions	5
Abstract	5
I. INTRODUCTION	6
II. STRUCTURE MODELING GUIDELINES	7
1. Wire Modeling	7
2. Surface Modeling	10
3. Modeling Structures Over Ground	13
III. PROGRAM INPUT	15
1. Comment Cards (CM, CE)	15
2. Structure Geometry Input Cards	16
+ Wire Arc Specification (GA)	16
+ End Geometry Input (GE)	17
+ Read Numerical Green's Function File (GF)	19
+ Helix/Spiral Specification (GH)	20
+ Coordinate Transformation (GM)	21
+ Generate Cylindrical Structure (GR)	23
+ Scale Structure Dimensions (GS)	25
+ Wire Specification (GW)	26
+ Reflection in Coordinate Planes (GX)	28
+ Surface Patch (SP)	30
+ Multiple Patch Surface (SM)	34
+ Examples of Structure Geometry Data	36
- Rhombic Antenna - No Symmetry	36
- Rhombic Antenna - Plane Symmetry, 2 Planes	37
- Rhombic Antenna - Plane Symmetry, 1 Plane	38
- Two Coaxial Rings	39

- Linear Antenna over a Wire Grid Plate	40
- Cylinder with Attached Wires	41
3. Program Control Cards	43
+ Maximum Coupling Calculation (CP)	45
+ Extended Thin-Wire Kernel (EK)	46
+ End of Run (EN)	47
+ Excitation (EX)	48
+ Frequency (FR)	52
+ Additional Ground Parameters (GD)	53
+ Ground Parameters (GN)	55
+ Interaction Approximation Range (KH)	57
+ Loading (LD)	58
+ Near Fields (NE, NH)	60
+ Networks (NT)	62
+ Next Structure (NX)	65
+ Print Control for Charge on Wires (PQ)	66
+ Page Title / Print Control for Current on Wires (PT)	67
+ Radiation Pattern (RP)	69
+ Transmission Line (TL)	73
+ Write NGF File (WG)	75
+ Execute (XQ)	76
4. SOMNEC Input for Sommerfeld/Norton Ground Method	77
5. The Numerical Green's Function Option	78
IV. NEC OUTPUT	80
o Examples 1 through 4	82
+ Example 1, Center-Fed Linear Antenna: Model, Results	83
+ Example 2, Center-Fed Linear Antenna: Model, Results	86
+ Example 3, Vert. Antenna Over Ground: Model, Results	91
+ Example 4, T Ant. on Box over Perfect Ground: Model, Results	96
o Example 5: Log-Periodic Antenna	100
+ Model, Results	100, 101
o Example 6: Cylinder with Attached Wires	106
+ Model, Results	106
o Examples 7 & 8: Scattering by a Wire / Aircraft	114
+ Model, Results	114
o Example 9: Scattering by a Sphere	(n/a)

o Example 10: Monopole on Radial Wire Ground Screen	(n/a)
V. EXECUTION TIME	118
o Benchmark Times on Various Platforms	118
o "TEST299" Benchmark Input Data File	121
VI. DIFFERENCES BETWEEN NEC-2, NEC-1, AND AMP2	122
VII. FILE STORAGE REQUIREMENTS	123
VIII. ERROR MESSAGES	125
REFERENCES	130
Contributors to the Web Edition of this Manual	131

LIST OF ILLUSTRATIONS

Figure	Page
1 Patch Position and Orientation	10
2 Connection of a Wire to a Surface Patch	11
3 Patch Models for a Sphere	12
4 Bistatic RCS of a Sphere with $ka = 5.3$	
(a) Uniform segmentation	12
(b) Variable segmentation	13
5 Surface Patch Option (5a, 5b, 5c, 5d)	31, 32, 32, 32
6 Rectangular Surface Covered by Multiple Patches	34
7 Rhombic Antenna - No Symmetry	36
8 Rhombic Antenna - 2 Planes of Symmetry	37
9 Rhombic Antenna - 1 Plane of Symmetry	38
10 Coaxial Rings	39
11 Wire Grid Plate and Dipole	40
12 Development of Surface Model for Cylinder with Attached Wires	41
13 Segmentation of Cylinder for Wires Connected to End and Side	42
14 Specification of Incident Wave	50
15 Orientation of Current Element	50
16 Parameters for a Second Ground Medium	53
17 Segment Loaded by Means of a 2-Port Network	63
18 Coordinates for Radiated Field	70
19 Stick Model of Aircraft	114

Preface

The Numerical Electromagnetics Code (NEC) has been developed at the Lawrence Livermore Laboratory, Livermore, California, under the sponsorship of the Naval Ocean Systems Center and the Air Force Weapons Laboratory. It is an advanced version of the Antenna Modeling Program (AMP) developed in the early 1970's by MBAssociates for the Naval Research Laboratory, Naval Ship Engineering Center, U.S. Army ECOM/Communications Systems, U.S. Army Strategic Communications Command, and Rome Air Development Center under Office of Naval Research Contract N00014-71-C-0187. The present version of NEC is the result of efforts by G. J. Burke and A. J. Poggio of Lawrence Livermore Laboratory.

The documentation for NEC consists of three volumes:

Part I: NEC Program Description - Theory
Part II: NEC Program Description - Code
Part III: NEC User's Guide

The documentation has been prepared by using the AMP documents as foundations and by modifying those as needed. In some cases this led to minor changes in the original documents while in many cases major modifications were required.

Over the years many individuals have been contributors to AMP and NEC and are acknowledged here as follows:

- * R. W. Adams
- * J. N. Brittingham
- * G. J. Burke
- * F. J. Deadrick
- * K. K. Hazard
- * D. L. Knepp
- * D. L. Lager
- * R. J. Lytle
- * E. K. Miller
- * J. B. Morton
- * G. M. Pjerrou
- * A. J. Poggio
- * E. S. Selden

The support for the development of NEC-2 at the Lawrence Livermore Laboratory has been provided by the Naval Ocean Systems Center under MIPR-N0095376MP. Cognizant individuals under whom this project was carried out include:

- * J. Rockway
- * J. Logan

Previous development of NEC also included the support of the Air Force Weapons Laboratory (Project Order 76-090) and was monitored by J. Castillo and TSgt. H. Goodwin.

Work was performed under the auspices of the U. S. Department of Energy by the Lawrence Livermore National Laboratory under contract No. W-7405-Eng-48. Reference to a company or product name does not imply approval or recommendation of the product by the University of California or the U. S. Department of Energy to the exclusion of others that may be suitable.

Disclaimer for the Web and Microsoft Word Versions

This manual was originally prepared as an account of work sponsored by the United States Government. Neither the United States nor the United States Department of Energy, nor any of their employees, nor any of their contractors, subcontractors, or their employees, makes any warranty, express or implied, or assumes any legal liability or responsibility for the accuracy, completeness or usefulness of any information, apparatus, product or process disclosed, or represents that its use would not infringe privately-owned rights.

The Web (html) and Microsoft Word (WDBN) versions of this manual were derived from the original, printed version by uncompensated volunteers, through optical scanning and automatic character recognition (OCR), retyping, reformatting and other editing (see page 131). These processes have inevitably introduced errors and omissions, for which the United States Government, Lawrence Livermore National Laboratory and University of California have no responsibility. No assurance is made by anyone as to the completeness, accuracy, or suitability for any purpose of any version of this manual.

Users should be particularly alert for errors of the sort that occur frequently with OCR, *e.g.*, missed decimal points and minus signs; confusion of the numeral "1", the lower-case letter "l", and the upper-case letter "I"; misalignment of columns in card images due to miscounting of spaces; and incorrect word substitution by automatic spell-checking programs.

Abstract

The Numerical Electromagnetics code (NEC-2) is a computer code for analyzing the electromagnetic response of an arbitrary structure consisting of wires and surfaces in free space or over a ground plane. The analysis is accomplished by the numerical solution of integral equations for induced currents. The excitation may be an incident plane wave or a voltage source on a wire, while the output may include current and charge density, electric or magnetic field in the vicinity of the structure, and radiated fields. NEC-2 includes several features not contained in NEC-1, including an accurate method for modeling grounds, based on the Sommerfeld integrals, and an option to modify a structure without repeating the complete solution.

This manual contains instruction for use of the Code, including preparation of input data and interpretation of the output. Examples are included that show typical input and output and illustrate many of the special options available in NEC-2 [text missing?] covering the equations and details of the coding, are referenced.

Section I - INTRODUCTION

The Numerical Electromagnetics Code (NEC-2) is a user-oriented computer code for analysis of the electromagnetic response of antennas and other metal structures. It is built around the numerical solution of integral equations for the currents induced on the structure by sources or incident fields. This approach avoids many of the simplifying assumptions required by other solution methods and provides a highly accurate and versatile tool for electromagnetic analysis.

The code combines an integral equation for smooth surfaces with one specialized for wires to provide for convenient and accurate modeling of a wide range of structures. A model may include nonradiating networks and transmission lines connecting parts of the structure, perfect or imperfect conductors, and lumped element loading. A structure may also be modeled over a ground plane that may be either a perfect or imperfect conductor.

The excitation may be either voltage sources on the structure or an incident plane wave of linear or elliptic polarization. The output may include induced currents and charges, near electric or magnetic fields, and radiated fields. Hence, the program is suited to either antenna analysis or scattering and EMP studies.

The integral equation approach is best suited to structures with dimensions up to several wavelengths. Although there is no theoretical size limit, the numerical solution requires a matrix equation of increasing order as the structure size is increased relative to wavelength. Hence, modeling very large structures may require more computer time and file storage than is practical on a particular machine. In such cases standard high-frequency approximations such as geometrical optics, physical optics, or geometrical theory of diffraction may be more suitable than the integral equation approach used in NEC-2.

NEC-2 retains all features of the earlier version NEC-1 except for a restart option. Major additions in NEC-2 are the Numerical Green's Function for partitioned-matrix solution and a treatment for lossy grounds that is accurate for antennas very close to the ground surface. NEC-2 also includes an option to compute maximum coupling between antennas and new options for structure input.

This manual contains instructions for use of the NEC-2 code and sample runs to illustrate the output. The sample runs may also be used as a standard to check the operation of a newly duplicated or modified deck. There are two other manuals for NEC-2: Part I: NEC Program Description - Theory (ref. 1); and Part II: NEC Program Description - Code (ref. 2). Part I covers the equations and numerical methods, and Part II is a detailed description of the FORTRAN code.

Section II - STRUCTURE MODELING GUIDELINES

The basic devices for modeling structures with the NEC code are short, straight segments for modeling wires and flat patches for modeling surfaces. An antenna and any other conducting objects in its vicinity that affect its performance must be modeled with strings of segments following the paths of wires and with patches covering surfaces. Proper choice of the segments and patches for a model is the most critical step to obtaining accurate results. The number of segments and patches should be the minimum required for accuracy, however, since the program running time increases rapidly as this number increases. Guidelines for choosing segments and patches are given below and should be followed carefully by anyone using the NEC code. Experience gained by using the code will also aid the user in developing models.

1. Wire Modeling

A wire segment is defined by the coordinates of its two end points and its radius. Modeling a wire structure with segments involves both geometrical and electrical factors. Geometrically, the segments should follow the paths of conductors as closely as possible, using a piece-wise linear fit on curves.

The main electrical consideration is segment length Δ relative to the wavelength Λ . Generally, Δ should be less than about 0.1Λ at the desired frequency. Somewhat longer segments may be acceptable on long wires with no abrupt changes while shorter segments, 0.05Λ or less, may be needed in modeling critical regions of an antenna. The size of the segments determines the resolution in solving for the current on the model since the current is computed at the center of each segment. Extremely short segments, less than about $10^{-3} \Lambda$, should also be avoided since the similarity of the constant and cosine components of the current expansion leads to numerical inaccuracy.

The wire radius, a , relative to Λ is limited by the approximations used in the kernel of the electric field integral equation. Two approximation options are available in NEC: the thin-wire kernel and the extended thin-wire kernel. These are discussed in reference 1. In the thin-wire kernel, the current on the surface of a segment is reduced to a filament of current on the segment axis. In the extended thin-wire kernel, a current uniformly distributed around the segment surface is assumed. The field of the current is approximated by the first two terms in a series expansion of the exact field in powers of a^2 . The first term in the series, which is independent of a , is identical to the thin-wire kernel while the second term extends the accuracy for larger values of a . Higher order approximations are not used because they would require excessive computation time.

In either of these approximations, only currents in the axial direction on a segment are considered, and there is no allowance for variation of the current around the wire circumference. The acceptability of these approximations depends on both the value of a/Λ and the tendency of the excitation to produce circumferential current or current variation. Unless $2\pi a/\Lambda$ is much less than 1, the validity of these approximations should be considered.

The accuracy of the numerical solution for the dominant axial current is also dependent on Δ/a . Small values of Δ/a may result in extraneous oscillations in the computed current near free wire ends, voltage sources,

or lumped loads. Use of the extended thin-wire kernel will extend the limit on Δ/a to smaller values than are permissible with the normal thin-wire kernel. Studies of the computed field on a segment due to its own current have shown that with the thin-wire kernel, Δ/a must be greater than about 8 for errors of less than 1%. With the extended thin-wire kernel, Δ/a may be as small as 2 for the same accuracy (ref. 3). In the current solution with either of these kernels, the error tends to be less than for a single field evaluation. Reasonable current solutions have been obtained with the thin-wire kernel for Δ/a down to about 2 and with the extended thin-wire kernel for Δ/a down to 0.5. When a model includes segments with Δ/a less than about 2, the extended thin-wire kernel option should be used by inclusion of an EK card in the data deck.

When the extended thin-wire kernel option is selected, it is used at free wire ends and between parallel, connected segments. The normal thin-wire kernel is always used at bends in wires, however. Hence, segments with small Δ/a should be avoided at bends. Use of a small Δ/a at a bend, which results in the center of one segment falling within the radius of the other segment, generally leads to severe error.

The current expansion used in NEC enforces conditions on the current and charge density along wires, at junctions, and at wire ends. For these conditions to be applied properly, segments that are electrically connected must have coincident end points. If segments intersect other than at their ends, the NEC code will not allow current to flow from one segment to the other. Segments will be treated as connected if the separation of their ends is less than about 10^{-3} times the length of the shortest segment. When possible, however, identical coordinates should be used for connected segment ends.

The angle of the intersection of wire segments in NEC is not restricted in any manner. In fact, the acute angle may be so small as to place the observation point on one wire segment within the volume of another wire segment. Numerical studies have shown that such overlapping leads to meaningless results; thus, as a minimum, one must ensure that the angle is large enough to prevent overlaps. Even with such care, the details of the current distribution near the intersection may not be reliable even though the results for the current may be accurate at distances from this region.

NEC includes a patch option for modeling surfaces using the magnetic-field integral equation. This formulation is restricted to closed surfaces with nonvanishing enclosed volume. For example, it is not theoretically applicable to a conducting plate of zero thickness and, actually, the numerical algorithm is not practical for thin bodies (such as solar panels). The latter difficulty is due to the possibility of poor conditioning of the matrix equation.

Wire-grid modeling of conducting surfaces has been used with varying success. The earliest applications to the computation of radar cross sections and radiation patterns provided reasonably accurate results. Even computations for the input impedance of antennas driven against grid models of surfaces have oftentimes exhibited good agreement with experiments. However, broad and generalized guidelines for near-field quantities have not been developed, and the use of wire-grid modeling for near-field parameters should be approached with caution. A single wire grid, however, may represent both surfaces of a thin conducting plate. The current on the grid will be the sum of the currents that would flow on opposite sites of the plate. While information on the currents on the individual surfaces is lost the grid will yield the correct radiated fields.

Other rules for the segment model follow:

- * Segments (or patches) may not overlap since the division of current between two overlapping segments is indeterminate. Overlapping segments may result in a singular matrix equation.
- * A large radius change between connected segments may decrease accuracy; particularly, with small Δ/a . The problem may be reduced by making the radius change in steps over several segments.
- * A segment is required at each point where a network connection or voltage source will be located. This may seem contrary to the idea of an excitation gap as a break in a wire. A continuous wire across the gap is needed, however, so that the required voltage drop can be specified as a boundary condition.
- * The two segments on each side of a charge density discontinuity voltage source should be parallel and have the same length and radius. When this source is at the base of a segment connected to a ground plane, the segment should be vertical.
- * The number of wires joined at a single junction cannot exceed 30 because of a dimension limitation in the code.
- * When wires are parallel and very close together, the segments should be aligned to avoid incorrect current perturbation from offset match point and segment junctions.
- * Although extensive tests have not been conducted, it is safe to specify that wires should be several radii apart.

2. Surface Modeling

A conducting surface is modeled by means of multiple, small flat surface patches corresponding to the segments used to model wires. The patches are chosen to cover completely the surface to be modeled, conforming as closely as possible to curved surfaces. The parameters defining a surface patch are the Cartesian coordinates of the patch center, the components of the outward-directed, unit normal vector and the patch area. These are illustrated in **Figure 1** where $r_0 = x_0 \hat{x} + y_0 \hat{y} + z_0 \hat{z}$ is the position of the segment center; $\hat{n} = n_x \hat{x} + n_y \hat{y} + n_z \hat{z}$ is the unit normal vector and A is the patch area.

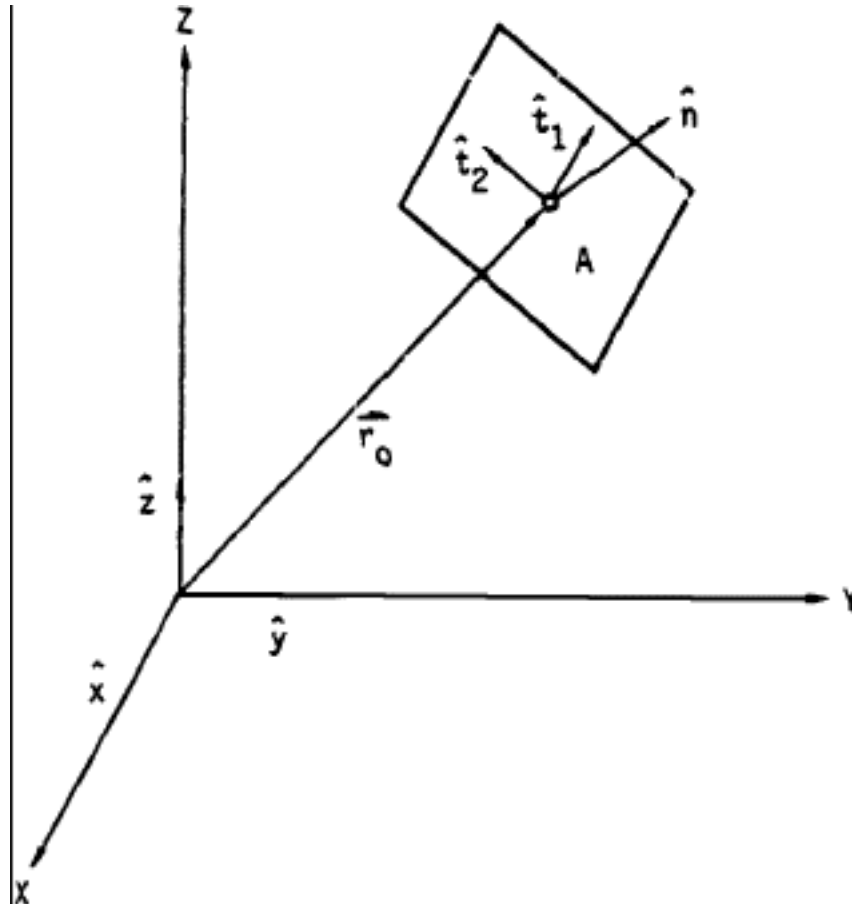

Figure 1. Patch Position and Orientation

Although the shape (square, rectangular, etc.) may be used to define a patch on input it does not affect the solution since there is no integration over the patch unless a wire is connected to the patch center. The program computes the surface current on each patch along the orthogonal unit vectors \hat{t}_1 and \hat{t}_2 , which are tangent to the surface. The vector \hat{t}_1 is parallel to a side of the triangular, rectangular, or quadrilateral patch. For a patch of arbitrary shape, it is chosen by the following rules:

For a horizontal patch,

$$\hat{t}_1 = \hat{x} .$$

For a non horizontal patch,

$$\hat{t}_1 = (\hat{z} \times \hat{n}) / | \hat{z} \times \hat{n} | ,$$

\hat{t}_2 is then chosen as $\hat{t}_2 = \hat{n} \times \hat{t}_1$. When a structure having plane symmetry is formed by reflection in a coordinate plane using a GX input card, the vectors \hat{t}_1 , \hat{t}_2 and \hat{n} are also reflected so that the new patches will have $\hat{t}_2 = -\hat{n} \times \hat{t}_1$. When a wire is connected to a surface, the wire must end at the center of a patch with identical coordinates used for the wire end and the patch center. The program then divides the patch into four equal patches about the wire end as shown in **Figure 2**, where a wire has been connected to the second of three previously identical patches. The connection patch is divided along lines defined by the vectors \hat{t}_1 and \hat{t}_2 for that patch, with a square patch assumed. The four new patches are ordinary patches like those input by the user, except when the interactions between the patches and the lowest segment on the connected wire are computed. In this case an interpolation function is applied to the four patches to represent the current from the wire onto the surface, and the function is numerically integrated over the patches. Thus, the shape of the patch is significant in this case. The user should try to choose patches so that those with wires connected are approximately square with sides parallel to \hat{t}_1 and \hat{t}_2 . The connected wire is not required to be normal to the patch but cannot lie in the plane of the patch. Only a single wire may connect to a given patch and a segment may have a patch connection on only one of its ends. Also, a wire may never connect to a patch formed by subdividing another patch for a previous connection.

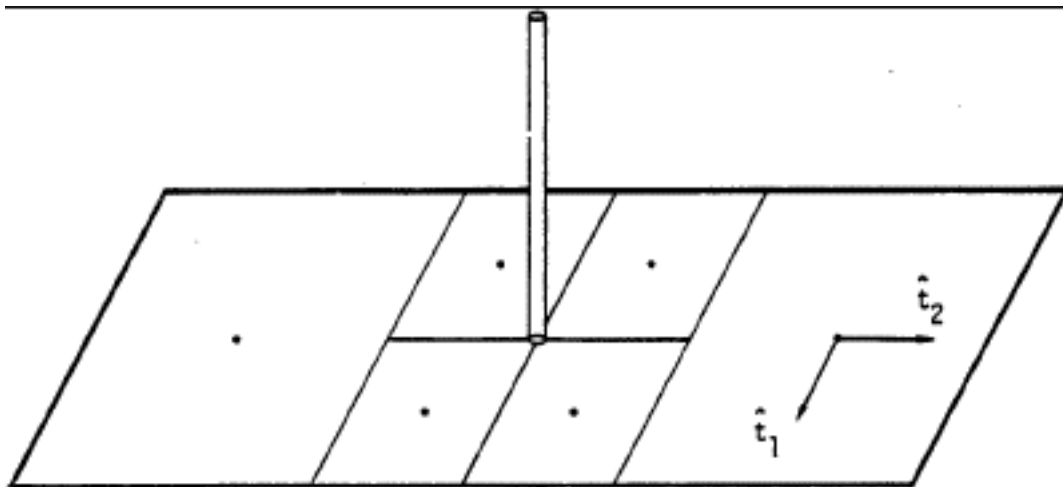
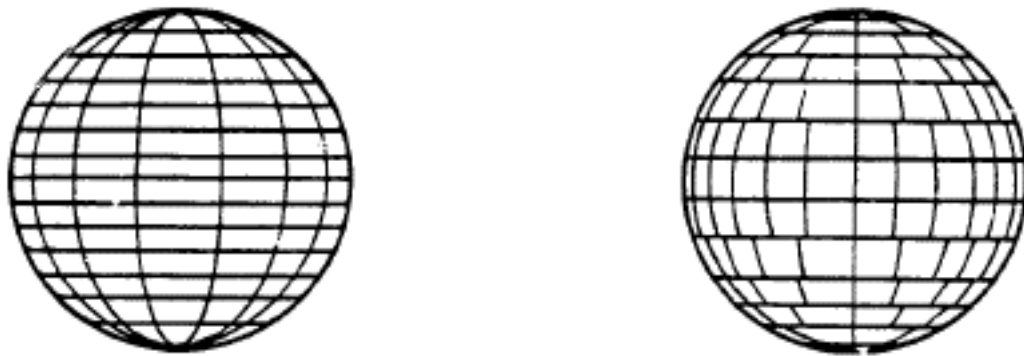

Figure 2. Connection of a Wire to a Surface Patch.

As with wire modeling, patch size measured in wavelengths is very important for accuracy of the results. A minimum of about 25 patches should be used per square wavelength of surface area, with the maximum size for an individual patch about 0.04 square wavelengths. Large patches may be used on large smooth surfaces while smaller patches are needed in areas of small radius of curvature, both for geometrical modeling accuracy and for accuracy of the integral equation solution. In the case of an edge, a precise local representation cannot be included; however, smaller patches in the vicinity of the edge can lead to more accurate results since the current magnitude may vary rapidly in this region. Since connection of a wire to a patch causes the patch to be divided into four smaller patches, a larger patch may be input in anticipation of the subdivision.

While patch shape is not input to the program, very long narrow patches should be avoided when subdividing the surface. This is illustrated by the two methods of modeling a sphere shown in **Figure 3**. The first uses uniform division in azimuth and equal cuts along the vertical axis. This results in all patches having equal areas but with long narrow patches near the poles. In the second method, the number of divisions in azimuth is increased toward the equator so that the patch length and width are kept more nearly equal. The areas are again kept approximately equal.



Uniform Segmentation

Variable Segmentation

Figure 3. Patch Models for a Sphere.

The results of the two segmentations are shown in **Figure 4** for scattering by a sphere of ka (2^1 radius/wavelength) equal to 5.3. The uniform segmentation used 14 increments in azimuth and 14 equal bands along the vertical axis. The variable segmentation used 13 equal increments in arc length along the vertical axis, with each band from top to bottom divided into the following number of patches in azimuth: 4, 8, 12, 16, 20, 24, 24, 24, 20, 16, 12, 8, 4. Much better agreement with experiment is obtained with the variable segmentation.

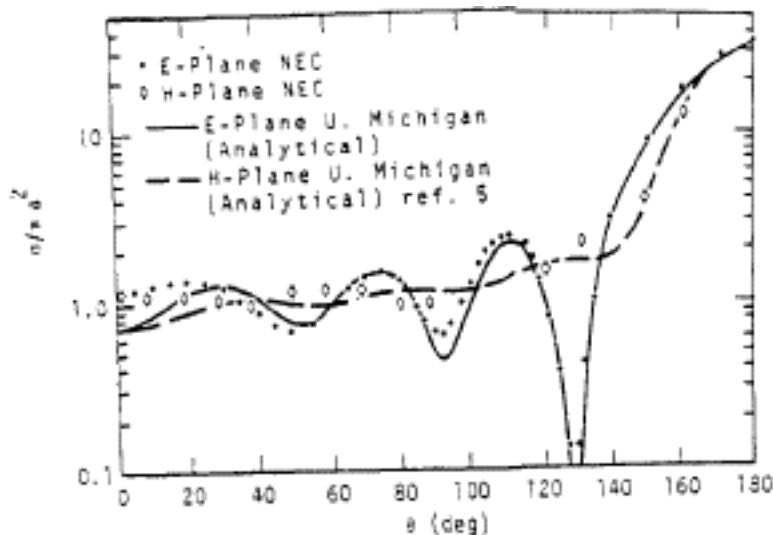

(a) Uniform Segmentation

Figure 4. Bistatic RCS of a Sphere with $ka = 5.3$.

(Figure 4 continues ->

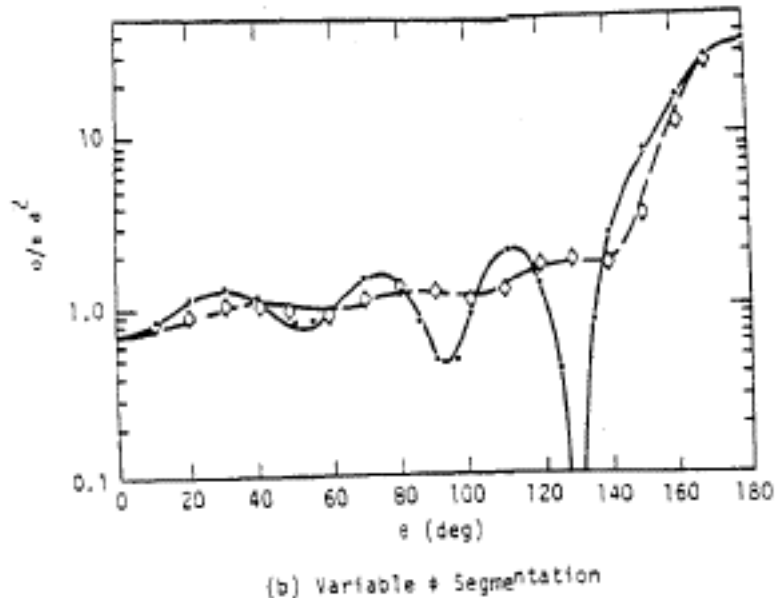

Figure 4. Bistatic RCS of a Sphere with $ka = 5.3$ (continuation).

In general, the use of surface patches is restricted to modeling voluminous bodies. The surface modeled must be closed since the patches only model the side of the surface from which their normals are directed outward. If a somewhat thin body, such as a box with one narrow dimension, is modeled with patches the narrow sites (edges) must be modeled as well as the broad surfaces. Furthermore, the parallel surface on opposite sides cannot be too close together or severe numerical error will occur.

When modeling complex structures with features not previously encountered, accuracy may be checked by comparison with reliable experimental data if available. Alternatively, it may be possible to develop an idealized model for which the correct results can be estimated while retaining the critical features of the desired model. The optimum model for a class of structures can be estimated by varying the segment and patch density and observing the effect on the results. Some dependence of results on segmentation will always be found. A large dependence, however, would indicate that the solution has not converged and more segments or patches should be used. A model will generally be usable over a band of frequencies. For frequencies beyond the upper limit of a particular model, a new set of geometry cards must be input with a finer segmentation.

3. Modeling Structures Over Ground

Several options are available in NEC for modeling an antenna over a ground plane. For a perfectly conducting ground, the code generates an image of the structure reflected in the ground surface. The image is exactly equivalent to a perfectly conducting ground and results in solution accuracy comparable to that for a free-space model. Structures may be close to the ground or contacting it in this case. However, for a horizontal wire with radius a , and height h to the wire axis, $[h^2 + a^2]^{1/2}$ should be greater than about 10^{-6} wavelengths. Furthermore, the height should be at least several times the radius for the thin-wire approximation to be valid. This method doubles the time to fill the interaction matrix. A finitely conducting ground may be modeled by an image modified by the Fresnel plane-wave reflection coefficients. This method is fast but of limited accuracy and should not be

used for structures close to the ground. The reflection coefficient approximation for the near fields can yield reasonable accuracy if the structure is a least several tenths of a wavelength above the ground. It should not be used for structures having a large horizontal extent over the ground such as some traveling-wave antennas. An alternate method (Sommerfeld/Norton), available for wires only, uses the exact solution for the fields in the presence of ground and is accurate close to the ground. For a horizontal wire the height restriction is the same as for a perfect ground. When this method is used NEC requires an input file (TAPE21) containing field values for the specific ground parameters and frequency. This interpolation table must be generated by running a separate program, SOMNEC, prior to the NEC run. The present NEC code uses the Sommerfeld/Norton method only for wire-to-wire interactions. If Sommerfeld/Norton is requested for a structure that includes surfaces, the reflection coefficient approximation will be used for surface-to-surface and surface-to-wire interactions. Computation of wire-to-wire interactions by the Sommerfeld/Norton method take about four times longer than for free space. In addition, computation of the interpolation table requires about 15 s on a CDC 7600 computer. However, the file of interpolation tables may be saved and reused for problems having the same ground parameters and frequency. The Sommerfeld/Norton method is not available in the earlier code, NEC-1.

A wire ground screen may be modeled with the Sommerfeld/Norton method if it is raised slightly above the ground surface. A ground stake cannot be modeled in NEC since there is presently no provision to compute interactions across the interface. Wires may end on a ground plane with a condition that the charge density (i.e., derivative of current) be zero at the base of the wire, but this is accurate only for a perfectly conducting ground. A wire may end on a finitely conducting ground with the charge set to zero at the connection, but this will not accurately model a ground stake. If a wire is driven against a finitely conducting ground in this way, the input impedance will typically be dependent on length of the source segment.

NEC also includes options for a radial-wire ground-screen approximation and two-medium ground approximation (cliff) based on modified reflection coefficients. These methods are implemented only for wires and not for patches, however. For the radial-wire ground-screen approximation, an approximate surface impedance - based on the wire density and the ground parameters - is computed at specular reflection points. Since the formula for surface impedance yields zero at the center of the screen, the current on a vertical monopole will be the same as over a perfect ground. The ground screen approximation is used in computing both near-field interactions and the radiated field. It should be noted that diffraction from the edge of the screen is not included. When limited accuracy can be accepted, the ground screen approximation provides a large time saving over explicit modeling with the Sommerfeld/Norton method since the ground screen does not increase the number of unknowns in the matrix equation.

The two-medium ground approximation permits the user to define a linear or circular cliff with different ground parameters and ground height on opposite sides. This approximation is not used for the near-field interactions affecting the currents but is used in computing the radiated field. The reflection coefficient is based on the ground parameters and height at the specular-reflection point for each ray. This option may also be used to compute the current over a perfect ground and then compute radiated fields for a finitely conducting ground.

Section III - PROGRAM INPUT

1. Comment Cards (CM, CE)

The data-card deck for a run must begin with one or more comment cards which can contain a brief description and structure parameters for the run. The cards are printed at the beginning of the output of the run for identification only and have no effect on the computation. Any alphabetic and numeric characters can be punched on these cards. The comment cards, like all other data cards, have a two-letter identifier in columns 1 and 2. The two forms for comment cards are:

Card:

/2	5	10	15	20	30	40	50	60	70	80
CM										
The numbers along the top refer to the last column in each field.										

/2	5	10	15	20	30	40	50	60	70	80
CE										
The numbers along the top refer to the last column in each field.										

When a CM card is read, the contents of columns 3 through 80 are printed in the output, and the next card is read as a comment card. When a CE card is read, columns 3 through 80 are printed, and reading of comments is terminated. The next card must be geometry card. Thus, a CE Card must always occur in a data deck and may be preceded by as many CM cards as are needed to describe the run.

2. Structure Geometry Input Cards

Wire Arc Specification (GA)

Purpose: To generate a circular arc of wire segments.

Card:

/	2	5	10	20	30	40	50	60	70	80
	GA	I1	I2	F1	F2	F3	F4 R	blank	blank	blank
		I	N	R	A	A	A			
		T	S	A	N	N	D			
		G		D	G	G				
				A	1	2				

The numbers along the top refer to the last column in each field.

Field	Parameter	Last column in each field
----	----	-----
GA		2
ITG	I1	5
NS	I2	10
RADA	F1	20
ANG1	F2	30
ANG2	F3	40
RAD	F4	50
blank		60
blank		70
blank		80

Parameters:

Integers

- ITG (I1) - Tag number assigned to all segments of the wire arc.
- NS (I2) - Number of segments into which the arc will be divided.

Decimal Numbers

- RADA (F1) - Arc radius (center is the origin and the axis is the y axis).
- ANG1 (F2) - Angle of first end of the arc measured from the x axis in a left-hand direction about the y axis (degrees).
- ANG2 (F3) - Angle of the second end of the arc.
- RAD (F4) - Wire radius.

Notes:

- * The segments generated by GA form a section of polygon inscribed within the arc.
- * If an arc in a different position or orientation is desired the segments may be moved with a GM card.
- * Use of GA to form a circle will not result in symmetry being used in the calculation. It is a good way to form the beginning of the circle, to be completed by GR, however.
- * (See notes for GW.)

End Geometry Input (GE)

Purpose: To terminate reading of geometry data cards and reset geometry data if a ground plane is used.

Card:

Field	Parameter	Last column in each field
----	----	-----
GE		2
I1	gpflag	5
blank		10
blank		20
blank		30
blank		40
blank		50
blank		60
blank		70
blank		80

Parameters:

Integers:

gpflag - Geometry ground plain flag.

0 - no ground plane is present.

1 - Indicates a ground plane is present. Structure symmetry is modified as required, and the current expansion is modified so that the currents an segments touching the ground (x, Y plane) are interpolated to their images below the ground (charge at base is zero)

-1 - indicates a ground is present. Structure symmetry is modified as required. Current expansion, however, is not modified, Thus, currents on segments touching the ground will go to zero at the ground.

Decimal Numbers:

The decimal number fields are not used.

Notes:

- * The basic function of the GE card is to terminate reading of geometry data cards. In doing this, it causes the program to search through the segment data that have been generated by the preceding cards to determine which wires are connected for current expansion.
- * At the time that the GE card is read, the structure dimensions must be in units of meters.
- * A positive or negative value of I1 does not cause a ground to be included in the calculation. It only modifies the geometry data as required when a ground is present. The ground parameters must be specified on a program control card following the geometry cards.
- * When I1 is nonzero, no segment may extend below the ground plane (X,Y plane) or lie in this plane. Segments may end on the ground plane, however.

- * If the height of a horizontal wire is less than 10^{-3} times the segment length, I1 equal to 1 will connect the end of every segment in the wire to ground. I1 should be -1 to avoid this disaster.
- * As an example of how the symmetry of a structure is affected by the presence of ground plane (X,Y plane), consider a structure generated with cylindrical symmetry about the Z axis. The presence of a ground does not effect the cylindrical symmetry. If however this same structure is rotated off the vertical, cylindrical symmetry is lost in the presence of the ground. As a second example, consider a dipole parallel to the Z axis, which was generated with symmetry about its feed. The presence of a ground plane destroys this symmetry. The program modifies structure symmetries as follows when I1 is nonzero. If the structure was rotated about the X or Y axis by the GM card, all symmetry is lost (i.e., the no-symmetry condition is set). If the structure was not rotated about the X or Y axis, only symmetry about a plane parallel to the X, Y plane is lost. Translation or a structure does not affect symmetries.

Read Numerical Green's Function File (GF)

Purpose: To read a previously written Numerical Green's Function ("NGF") file.

Card:

/2	5	10	15	20	30	40	50	60	70	80
/										
GF	I1				blank	blank	blank	blank	blank	blank
		b	b	b						
		l	l	l						
		a	a	a						
		n	n	n						
		k	k	k						
The numbers along the top refer to the last column in each field.										

Parameters:

Integers

(I1) - Prints a table of the coordinates of the ends of all segments in the NGF if I1 not equal to 0. Normal printing otherwise.

Notes:

- * GF must be the first card in the structure geometry section, immediately after CE. The effects of some other data cards are altered when a GF card is used.
- * See Section III-5.

Helix/Spiral Specification (GH)

Purpose: To generate a helix or spiral of wire segments

Card:

Cols	Parameter
1- 2	GH
3- 5	I1 - ITG
6-10	I2 - NS
11-20	F1 - S
21-30	F2 - HL
31-40	F3 - A1
41-50	F4 - B1
51-60	F5 - A2
61-70	F6 - B2
71-80	F7 - RAD

Parameters:

Integers

- ITG (11) - Tag number assigned to all segments of the helix or spiral.
- NS (12) - Number of segments into which the helix or spiral will be divided.

Floating Point

- S (F1) - Spacing between turns.
- HL (F2) - Total length of the helix.
- A1 (F3) - Radius in x at z = 0.
- B1 (F4) - Radius in y at z = 0.
- A2 (F5) - Radius in x at z = HL.
- B2 (F6) - Radius in y at z = HL.
- RAD (F7) - Radius of wire.

Notes:

- * Structure will be a helix if $A2 = A1$ and $HL > 0$.
- * Structure will be a spiral if $A2 = A1$ and $HL = 0$.
 - Unless it has been fixed in the codes in circulation, the use of $HL=0$ for a flat spiral will result in division by zero in NEC-2. GH was a non-official addition to NEC-2.
- * HL negative gives a left-handed helix.
- * HL positive gives a right-handed helix.

Coordinate Transformation (GM)

Purpose: To translate or rotate a structure with respect to the coordinate system or to generate new structures translated or rotated from the original.

Card:

/2	5	10	20	30	40	50	60	70	80
GM	I1	I2	F1	F2	F3	F4	F5	F6	F7
	I T G I	N R P T	ROX	ROY	ROZ	XS	XY	XZ	ITS

The numbers along the top refer to the last column in each field.

Parameters:

Integers

- ITGI (I1) - Tag number increment.
- NRPT (I2) - The number of new structures to be generated

Decimal Numbers

- ROX (F1) - Angle in degrees through which the structure is rotated about the X-axis. A positive angle causes a right-hand rotation.
- ROY (F2) - Angle of rotation about Y-axis.
- ROZ (F3) - Angle of rotation about Z-axis.
- XS (F4) - X, Y, Z components of vector by which
- YS (F5) - structure is translated with respect to
- ZS (F6) - the coordinate system.
- ITS (F7) - This number is input as a decimal number but is rounded to an integer before use. Tag numbers are searched sequentially until a segment having a tag of this segment **[OCR ERROR/OMISSION? -ccc]** through the end of the sequence of segments is moved by the card.
If ITS is blank (usual case) or zero, the entire structure is moved.

Notes:

- * If NRPT is zero, the structure is moved by the specified rotation and translation leaving nothing in the original location. If NRPT is greater than zero, the original structure remains fixed and NRPT new structures are formed, each shifted from the previous one by the requested transformation.
- * The tag increment, ITGI, is used when new structures are generated (NRPT greater than zero) to avoid duplication of tag numbers. Tag

numbers of the segments in each new copy of the structure are incremented by ITGI from the tags on the previous copy or original. Tags of segments which are generated from segments having no tags (tag equal to zero) are not incremented. Generally, ITGI will be greater than or equal to the largest tag number used on the original structure to avoid duplication of tags. For example, if tag numbers 1 through 100 have been used before a (GM) card is read having NRPT equal to 2, then ITGI equal to 100 will cause the first copy of the structure to have tags from 101 to 200 and the second copy from 201 to 300. If NRPT is zero, the tags on the original structure will be incremented.

- * The result of a transformation depends on the order in which the rotations and translation are applied. The order used is first rotation about X-axis, then rotation about the Y-axis, then rotation about the Z-axis and, finally, translation by (XS, YS, ZS). All operations refer to the fixed coordinate system axes. If a different order is desired, separate GM cards may be used.

Generate Cylindrical Structure (GR)

Purpose: To reproduce a structure by rotating about the Z-axis to form a complete cylindrical array, and to set flags so that symmetry is utilized in the solution.

Card:

```

Cols.  Parameter
-----
1- 2   GR
3- 5   I1
6-10  I2
11-20  blank
21-30  blank
31-40  blank
41-50  blank
51-60  blank
61-70  blank
71-80  blank
    
```

Parameters:

Integers

- (I1) - Tag number increment.
- (I2) - Total number of times that the structure is to occur in the cylindrical array.

Decimal Numbers

The decimal number fields are not used.

Notes:

- * The tag increment (I1) is used to avoid duplication of tag numbers in the reproduced structures. In forming a new structure for the array, all valid tags on the previous copy or original structure are incremented by (I1). Tags equal to zero are not incremented.
- * The GR card should never be used when there are segments on the Z-axis or crossing the Z-axis since overlapping segments would result.
- * The GR card sets flags so the program makes use of cylindrical symmetry in solving for the currents. If a structure modeled by N segments has M sections in cylindrical symmetry (formed by a GR card with I2 equal to M), the number of complex numbers in matrix storage and the proportionality factors for matrix fill time and matrix factor time are:

	Matrix Storage -----	Fill Time ----	Factor Time -----
No Symmetry	N^2	N^2	N^2
M Symmetric Sections	$(N^2)/M$	$(N^2)/M$	$(N^2)/M$

The matrix factor time represents the optimum for a large matrix factored in core. Generally, somewhat longer times will be observed.

- * If the structure is added to or modified after the GR card in such a way that cylindrical symmetry is destroyed, the program must be reset to a no-symmetry condition. In most cases, the program is set by the geometry routines for the existing symmetry. Operations that automatically reset the symmetry conditions are:
 - o Addition of a wire by a GW card destroys all symmetry.
 - o Generation of additional structures by a GM card, with NRPT greater than zero, destroys all symmetry.
 - o A GM card acting on only part of the structure (having ITS greater than zero) destroys all symmetry.
 - o A GX or GR card will destroy all previously established symmetry.
 - o If a structure is rotated about either the X or Y axis by use of a GM card and a ground plane is specified on the GE card, all symmetry will be destroyed. Rotation about the Z-axis or translation will not affect symmetry. If a ground is not specified, symmetry will be unaffected by any rotation or translation by a GM card, unless NRPT or ITS on the GM card is greater than zero.
- * Symmetry will also be destroyed if lumped loads are placed on the structure in an unsymmetric manner. In this case, the program is not automatically set to a no-symmetry condition but must be set by a data card following the GR card. A GW card with NS blank will set the program to a no-symmetry condition without modifying the structure. The card must specify a nonzero radius, however, to avoid reading a GC card.
- * Placement of nonradiating networks or sources does not affect symmetry.
- * When symmetry is used in the solution, the number of symmetric sections (I2) is limited by array dimensions. In the demonstration deck, the limit is 16 sections.
- * The GR card produces the same effect on the structure as a GM card if I2 on the GR card is equal to (NRPT+1) on the GM card and if ROZ on the GM card is equal to $360/(NRPT+1)$ degrees. If the GM card is used, however, the program will not be set to take advantage of symmetry.

Scale Structure Dimensions (GS)

Purpose: To scale all dimensions of a structure by a constant.

Card:

Cols.	Parameter
1- 2	GS
3- 5	blank
6-10	blank
11-20	F1
21-30	blank
31-40	blank
41-50	blank
51-60	blank
61-70	blank
71-80	blank

Parameters:

Integers

The integer fields are not used.

Decimal Numbers

(F1) - All structure dimensions, including wire radius, are multiplied by F1.

Notes:

- * At the end of geometry input, structure dimensions must be in units of meters. Hence, if the dimensions have been input in other units, a GS card must be used to convert to meters.

Wire Specification (GW)

Purpose: To generate a string of segments to represent a straight wire.

Card:

```

Cols.  Parameter
-----
 1- 2  GW
 3- 5  I1 - ITG
 6-10  I2 - NS
11-20  F1 - XW1
21-30  F2 - YW1
31-40  F3 - ZW1
41-50  F4 - XW2
51-60  F5 - YW2
61-70  F6 - ZW2
71-80  F7 - RAD
    
```

The above card defines a string of segments with radius RAD. If RAD is zero or blank, a second card is read to set parameters to taper the segment lengths and radius from one end of the wire to the other. The format for the second card (GC), which is read only when RAD is zero, is:

```

Cols.  Parameter
-----
 1- 2  GC
 3- 5  blank
 6-10  blank
11-20  F1 - RDEL
21-30  F2 - RAD1
31-40  F3 - RAD2
41-50  blank
51-60  blank
61-70  blank
71-80  blank
    
```

Parameters:

Integers

- ITG (I1) - Tag number assigned to all segments of the wire.
- NS (I2) - Number of segments into which the wire will be divided.

Decimal Numbers

- | | | | | |
|-----|---------------------|---|---|---------------|
| XW1 | (F1) - X coordinate | \ | > | of wire end 1 |
| YW1 | (F2) - Y coordinate | / | | |
| ZW1 | (F3) - Z coordinate | / | | |
| | | | | |
| XW2 | (F4) - X coordinate | \ | > | of wire end 2 |
| YW2 | (F5) - Y coordinate | / | | |
| ZW2 | (F6) - Z coordinate | / | | |

RAD (F7) - Wire radius, or zero for tapered segment option.

Optional GC card parameters:

RDEL (F1) - Ratio of the length of a segment to the length of the previous segment in the string.

RAD1 (F2) - Radius of the first segment in the string.

RAD2 (F3) - Radius of the last segment in the string.

The ratio of the radii of adjacent segments is

$$RRAD = (RAD2/RAD1)^{(1/(NS-1))}$$

If the total wire length is L, the length of the first segment is

$$S1 = L(1-RDEL)/(1-RDEL^{NS})$$

or

$$S1 = L/NS \text{ if } RDEL=1.$$

Notes:

- * The tag number is for later use when a segment must be identified, such as when connecting a voltage source or lumped load to the segment. Any number except zero can be used as a tag. When identifying a segment by its tag, the tag number and the number of the segment in the set of segments having that tag are given. Thus, the tag of a segment does not need to be unique. If no need is anticipated to refer back to any segments on a wire by tag, the tag field may be left blank. This results in a tag of zero which cannot be referenced as a valid tag.
- * If two wires are electrically connected at their ends, the identical coordinates should be used for the connected ends to ensure that the wires are treated as connected for current interpolation. If wires intersect away from their ends, the point of intersection must occur at segment ends within each wire for interpolation to occur. Generally, wires should intersect only at their ends unless the location of segment ends is accurately known.
- * The only significance of differentiating end one from end two of a wire is that the positive reference direction for current will be in the direction from end one to end two on each segment making up the wire.
- * As a rule of thumb, segment lengths should be less than 0.1 wavelength at the desired frequency. Somewhat longer segments may be used on long wires with no abrupt changes, while shorter segments, 0.05 wavelength or less, may be required in modeling critical regions of an antenna.
- * If input is in units other than meters, then the units must be scaled to meters through the use of a Scale Structure Dimensions (GS) card.

Reflection in Coordinate Planes (GX)

Purpose: To form structures having planes of symmetry by reflecting part of the structure in the coordinate planes, and to set flags so that symmetry is utilized in the solution.

Card:

Cols.	Parameter
1- 2	GX
3- 5	I1
6-10	I2
11-80	blank

Parameters:

Integers

- (I1) - Tag number increment.
- (I2) - This integer is divided into three independent digits, in columns 8, 9, and 10 of the card, which control reflection in the three orthogonal coordinate planes. A one in column 8 causes reflection along the X-axis (reflection in Y, Z plane); a one in column 9 causes reflection along the Y-axis; and a one in column 10 causes reflection along the Z axis. A zero or blank in any of these columns causes the corresponding reflection to be skipped.

Decimal Numbers

The decimal number fields are not used.

Notes:

- * Any combination of reflections along the X, Y and Z axes may be used. For example, 101 for (I2) will cause reflection along axes X and Z, and 111 will cause reflection along axes X, Y and Z. When combinations of reflections are requested, the reflections are done in reverse alphabetical order. That is, if a structure is generated in a single octant of space and a GX card is then read with I2 equal to 111, the structure is first reflected along the Z-axis; the structure and its image are then reflected along the Y-axis; and, finally, these four structures are reflected along the X-axis to fill all octants. This order determines the position of a segment in the sequence and, hence, the absolute segment numbers.
- * The tag increment I1 is used to avoid duplication of tag numbers in the image segments. All valid tags on the original structure are incremented by I1 on the image. When combinations of reflections are employed, the tag increment is doubled after each reflection. Thus, a tag increment greater than or equal to the largest tag on the original structure will ensure that no duplicate tags are generated. For example, if tags from 1 to 100 are used on the original structure with I2 equal to 011 and a tag increment of 100, the first reflection, along the Z-axis, will produce tags from 101 to 200; and the second reflection, along the Y-axis, will produce tags from 201 to 400, as a result of the increment being doubled to 200.
- * The GX card should never be used when there are segments located in the plane about which reflection would take place or crossing this plane. The image segments would then coincide with or intersect the original

segments, and such overlapping segments are not allowed. Segments may end on the image plane, however.

- * When a structure having plane symmetry is formed by a GX card, the program will make use of the symmetry to simplify solution for the currents. The number of complex numbers in matrix storage and the proportionality factors for matrix fill time and matrix factor time for a structure modeled by N segments are:

No. of Planes of Symmetry	Matrix Storage	Fill Time	Factor Time
0	N^2	N^2	N^3
1	$N^2/2$	$N^2/2$	$N^3/4$
2	$N^2/4$	$N^2/4$	$N^3/16$
3	$N^2/8$	$N^2/8$	$N^3/64$

The matrix factor time represents the optimum for a large matrix factored in core. Generally, somewhat longer times will be observed.

- * If the structure is added to or modified after the GX card in such a way that symmetry is destroyed, the program must be reset to a no-symmetry condition. In most cases, the program is set by the geometry routines for the existing symmetry. Operations that automatically reset the symmetry condition are:
 - o Addition of a wire by a GW card destroys all symmetry.
 - o Generation of additional structures by a GM card, with NRPT greater than zero, destroys all symmetry.
 - o A GM card acting on only part of the structure (having ITS greater than zero) destroys all symmetry.
 - o A GX card or GR card will destroy all previously established symmetry. For example, two GR cards with I2 equal to 011 and 100, respectively, will produce the same structure as a single GX card with I2 equal to 111; however, the first case will set the program to use symmetry about the Y, Z plane only while the second case will make use of symmetry about all three coordinate planes.
 - o If a ground plane is specified on the GE card, symmetry about a plane parallel to the X, Y plane will be destroyed. Symmetry about other planes will be used, however.
 - o If a structure is rotated about either the X or Y axis by use of a GM card and a ground plane is specified on the GE card, all symmetry will be destroyed. Rotation about the Z-axis or translation will not affect symmetry. If a ground is not specified, no rotation or translation will affect symmetry conditions unless NRPT on the GM card is greater than zero.
 - o Symmetry will also be destroyed if lumped loads are placed on the structure in an unsymmetric manner. In this case, the program is not automatically set to a no-symmetry condition but must be set by a data card following the GX card. A GW card with NS blank will set the program to a no-symmetry condition without modifying the structure. The card must specify a nonzero radius, however, to avoid reading a GC card.
- * Placement of sources or nonradiating networks does not affect symmetry.

Surface Patch (SP)

Purpose: To input parameters of a single surface patch.

Card:

Cols	Parameter
1- 2	SP
3- 5	I1 - blank
6-10	I2 - NS
11-20	F1 - X1
21-30	F2 - Y1
31-40	F3 - Z1
41-50	F4 - X2
51-60	F5 - Y2
61-70	F6 - Z2
71-80	blank

If NS is 1, 2, or 3, a second card is read in the following format:

Cols	Parameter
1- 2	SC
3- 5	I1 - blank
6-10	I2 - (see Notes)
11-20	F1 - X3
21-30	F2 - Y3
31-40	F3 - Z3
41-50	F4 - X4
51-60	F5 - Y4
61-70	F6 - Z4
71-80	blank

Parameters:

Integers:

- (I1) - not used
- NS (I2) - Selects patch shape
 - 0: (default) arbitrary patch shape
 - 1: rectangular patch
 - 2: triangular patch
 - 3: quadrilateral patch

Decimal Numbers:

o Arbitrary shape (NS = 0)

- X1 (F1) - X coordinate of patch center
- Y1 (F2) - Y coordinate of patch center
- Z1 (F3) - Z coordinate of patch center

- X2 (F4) - elevation angle above the X-Y plane of outward normal vector (degrees)
- Y2 (F5) - azimuth angle from X-axis of outward normal vector (degrees)
- Z2 (F6) - patch area (square of units used)

o Rectangular, triangular, or quadrilateral patch (NS = 1, 2, or 3)

- X1 (F1) X coordinate of corner 1
- Y1 (F2) Y coordinate of corner 1
- Z1 (F3) Z coordinate of corner 1

- X2 (F4) X coordinate of corner 2
- Y2 (F5) Y coordinate of corner 2
- Z2 (F6) Z coordinate of corner 2

- X3 (F1) X coordinate of corner 3
- Y3 (F2) Y coordinate of corner 3
- Z3 (F3) Z coordinate of corner 3

o For the quadrilateral patch only (NS = 3)

- X4 (F4) X coordinate of corner 4
- Y4 (F5) Y coordinate of corner 4
- Z4 (F6) Z coordinate of corner 4

Notes:

* The four patch options are shown in **Figures 5a, 5b, 5c, 5d**. For the rectangular, triangular, and quadrilateral patches the outward normal vector \hat{n} is specified by the ordering of corners 1, 2, and 3 and the right-hand rule.

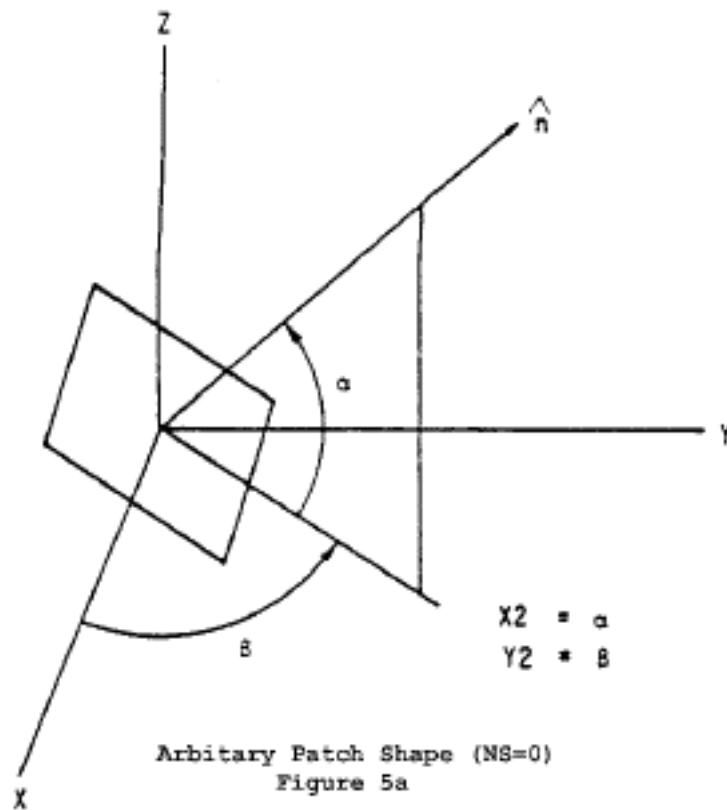

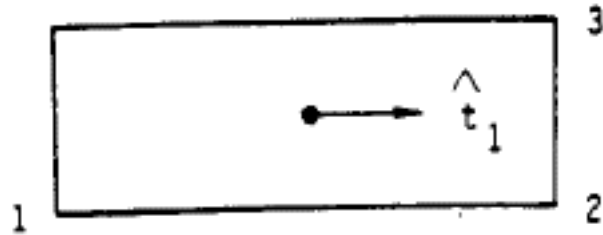

Rectangular Patch (NS = 1)

Figure 5b

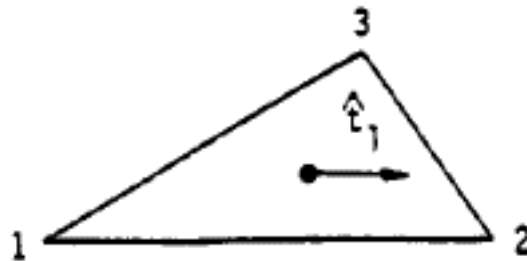

Triangular Patch (NS = 2)

Figure 5c

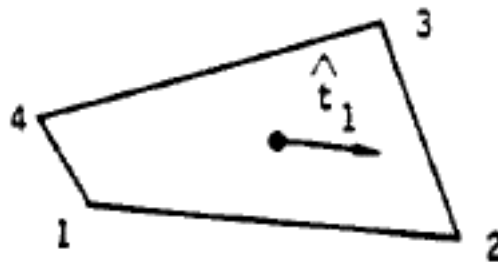

Quadrilateral Patch (NS = 3)

Figure 5d

- * For a rectangular, triangular, or quadrilateral patch, t_1 is parallel to the side from corner 1 to corner 2. For NS = 0, t_1 is chosen as described in section II-2.
- * If the sides from corner 1 to corner 2 and from corner 2 to corner 3 of the rectangular patch are not perpendicular, the result will be a parallelogram.
- * If the four corners of the quadrilateral patch do not lie in the same plane, the run will terminate with an error message.
- * Since the program does not integrate over patches, except at a wire connection, the patch shape does not affect the results. The only parameters affecting the results are the location of the patch centroid, the patch area, and the outward unit normal vector. For the arbitrary patch shape these are input, while for the other options they

are determined from the specified shape. For solution accuracy, however, the distribution of patch centers obtained with generally square patches has been found to be desirable (see section II-2).

- * For the rectangular or quadrilateral options, multiple SC cards may follow a SP card to specify a string of patches. The parameters on the second or subsequent SC card specify corner 3 for a rectangle or corners 3 and 4 for a quadrilateral, while corners 3 and 4 of the previous patch become corners 2 and 1, respectively, of the new patch. The integer I2 on the second or subsequent SC card specifies the new patch shape and must be 1 for rectangular shape or 3 for quadrilateral shape. On the first SC card after SP, I2 has no effect. Rectangular or quadrilateral patches may be intermixed, but triangular or arbitrary shapes are not allowed in a string of linked patches.

Multiple Patch Surface (SM)

Purpose: To cover a rectangular region with surface patches.

Card:

```
SM  I1  I2  F1   F2   F3   F4   F5   F6   blank
      NX  NY  X1   Y1   Z1   X2   Y2   Z2
```

A second card with the following format must immediately follow a SM card:

```
SC          F1   F2   F3   F4   F5   F6   blank
          X3   Y3   Z3
```

Parameters:

Integers:

```
NX  (I1) \ The rectangular surface is divided into NX patches
      |   | from corner 1 to corner 2 and NY patches from
      |   | corner 2 to corner 3.
NY  (I2) /
```

Decimal Numbers:

```
X1  (F1) \
Y1  (F2) | X, Y, Z coordinates of corner 1
Z1  (F3) /

X2  (F4) \
Y2  (F5) | X, Y, Z coordinates of corner 2
Z2  (F6) /

X3  (F7) \
Y3  (F8) | X, Y, Z coordinates of corner 3
Z3  (F9) /
```

Notes:

- o The division of the rectangle into patches is as illustrated in **Figure 6**.

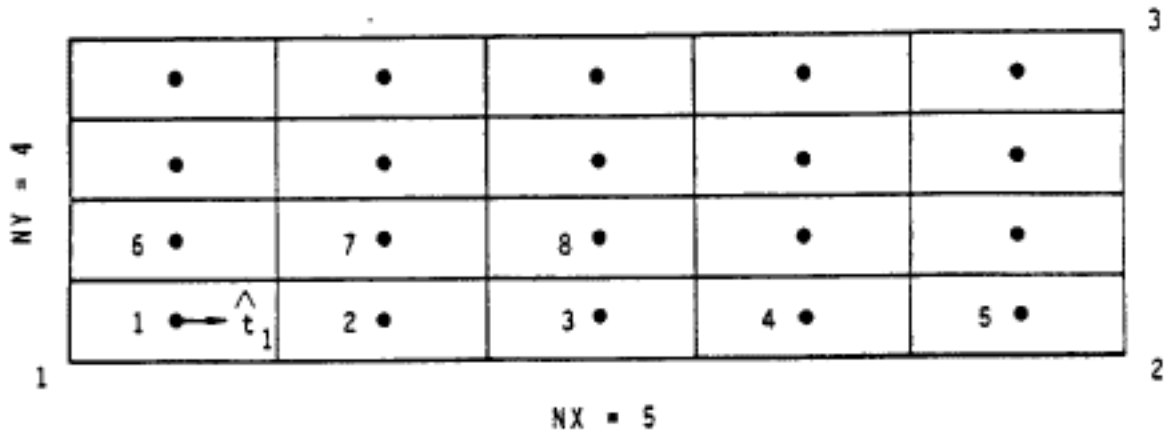

Figure 6. Rectangular Surface Covered by Multiple Patches.

- o The direction of the outward normals \hat{n} of the patches is determined by the ordering of corners 1, 2, and 3 and the right-hand rule. The vectors \hat{t}_1 are parallel to the side from corner 1 to corner 2 and $\hat{t}_2 = \hat{n} \times \hat{t}_1$. The patch may have arbitrary orientation.
- o If the sides between corners 1 and 2 and between corners 2 and 3 are not perpendicular, the complete surface and the individual patches will be parallelograms.
- o Multiple SC cards are not allowed with SM.

Examples of Structure Geometry Data

Rhombic Antenna - No Symmetry

Structure: **Figure 7.**

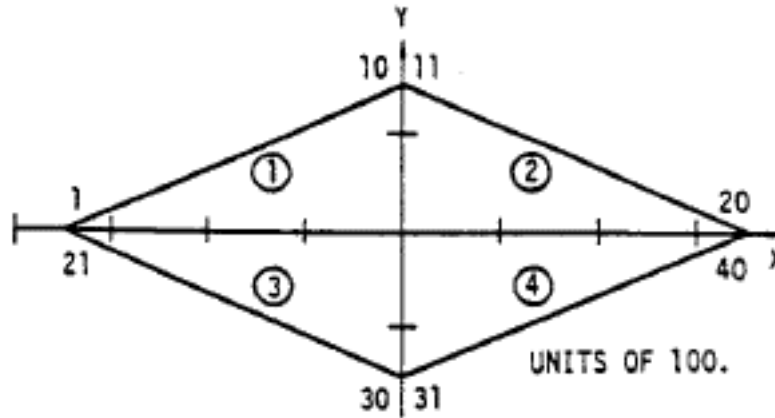

Figure 7. Rhombic Antenna - No Symmetry.

Geometry Data Cards

```

GW 1  10 -350.      0.  150.  0.  150.  150.  .1
GW 2  10  0.       150.  150. 350.  0.  150.  .1
GW 3  10 -350.      0.  150.  0. -150. 150.  .1
GW 4  10  0.       -150. 150. 350.  0.  150.  .1
GS           0.30480
GE
    
```

Number of Segments: 40

Symmetry: None

These cards generate segment data for a rhombic antenna. The data are input in feet and scaled to meters. In the figure, numbers near the structure represent segment numbers and circled numbers represent tag numbers.

Rhombic Antenna - Plane Symmetry, 2 Planes

Structure: See **Figure 8**.

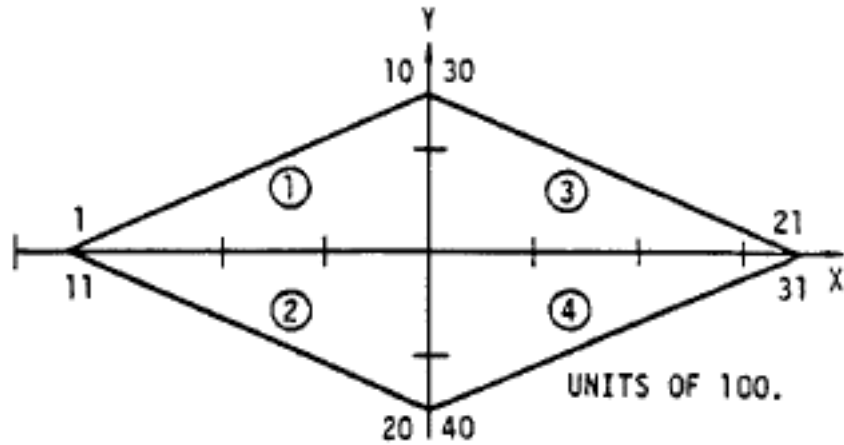

Figure 8. Rhombic Antenna - 2 Planes of Symmetry.

Geometry Data Cards

```

GW 1  10 -350.      0. 150.   0. 150.  150. .1
GX 1  110
GS      0.30480
GE
    
```

Number of Segments: 40

Symmetry: Two planes

These cards generate the same structure as the previous set although the segment numbering is altered. By making use of two planes of symmetry, these data will require storage of only a 10 by 40 interaction matrix. If segments 21 and 31 are to be loaded as the termination of the antenna, then symmetry about the YZ plane cannot be used. The following cards will result in symmetry about only the XZ plane being used in the solution, thus allowing segments on one end of the antenna to be loaded.

Rhombic Antenna - Plane Symmetry, 1 Plane

Structure: **Figure 9.**

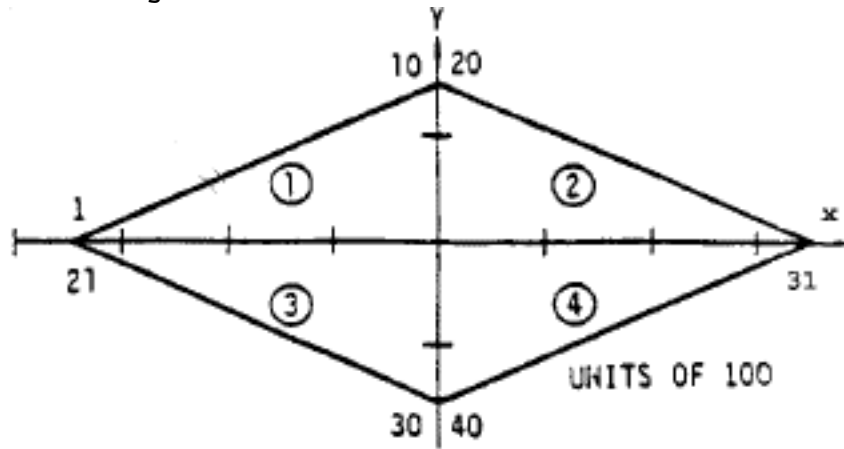

Figure 9. Rhombic Antenna - 1 Plane of Symmetry.

Geometry Data Cards:

```

GW 1 10 -350.      0. 150.  0. 150. 150. .1
GX 1 100
GX 2 010
GS          0.30480
GE
    
```

Number of Segments: 40

Symmetry: One plane

Segments 1 through 20 of this structure are in the first symmetric section. Hence, segments 11 and 31 can be loaded without loading segments 1 and 21 (Loading segments in symmetric structures is discussed in the section covering the LD card). These data will cause storage of a 20 by 40 interaction matrix.

Two Coaxial Rings

Structure: **Figure 10.**

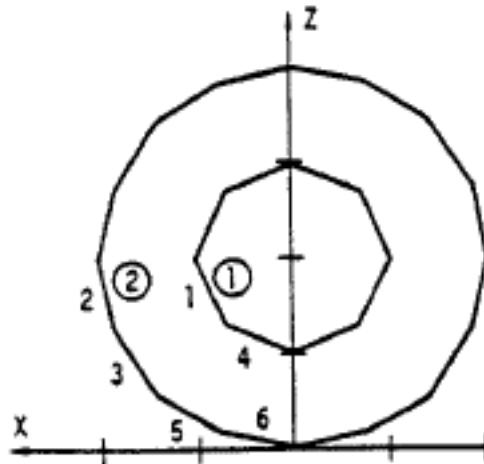

Figure 10. Coaxial Rings.

Geometry Data Cards:

GW	1	1.0	0.	0.	0.70711	0.70711	0.	.001
GW	2	2.0	0.	0.	0.76536	1.84776	0.	.001
GW	2	0.76536	1.84776	0.	1.41421	1.41421	0.	.001
GR	8							
GM		90.0	0.	0.	0.	0.	2.0	
GE								

Number of Segments: 24

Symmetry: 8 section cylindrical symmetry

The first 45 degree section of the two rings is generated by the first three GW cards. This section is then rotated about the X-axis to complete the structure. The rings are then rotated about the X-axis and elevated to produce the structure shown. Since no tag increment is specified on the GR card, all segments on the first ring have tags of 1 and all segments on the second ring have tags of 2. Because of symmetry, these data will require storage of only a 3 by 24 interaction matrix. If a 1 were punched in column 5 of the GE card, however, symmetry would be destroyed by the interaction with the ground, requiring storage of a 24 by 24 matrix

Linear Antenna over a Wire Grid Plate

Structure: **Figure 11.**

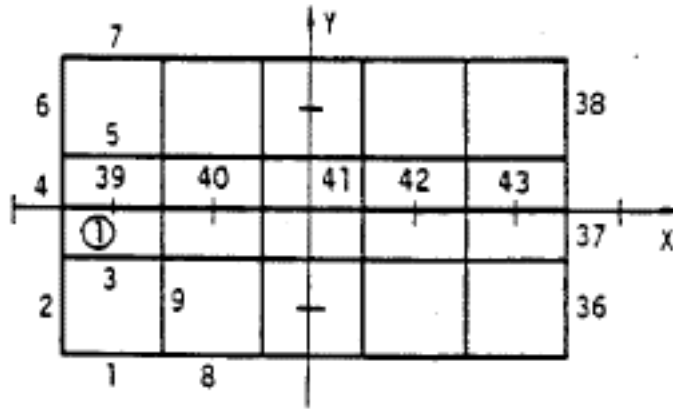

Figure 11. Wire Grid Plate and Dipole.

Geometry Data Cards:

GW	1	0.	0.	0.	0.1	0.	0.	.001
GW	1	0.	0.	0.	0.	0.1	0.	.001
GM	2	0.	0.	0.	0.	0.1	0.	
GW	1	0.	0.3	0.0	0.1	0.3	0.	.001
GM	4	0.	0.	0.	0.1	0.	0.	
GW	3	0.5	0.	0.	0.5	0.3	0.	.001
GM		0.	0.	0.	-0.25	-0.15	0.	
GW	1	5	-0.25	0.	0.15	0.25	0.	0.15
GE								

Number of Segments: 43

Symmetry: None

The first 6 cards generate data for the wire grid plate, with the lower left-hand corner at the coordinate origin, by using the GM card to reproduce sections of the structure. The GM card is then used to move the center of the plate to the origin. Finally, a wire is generated 0.15 meters above the plate with a tag of 1.

Cylinder with Attached Wires

Structure: See **Figure 12.**

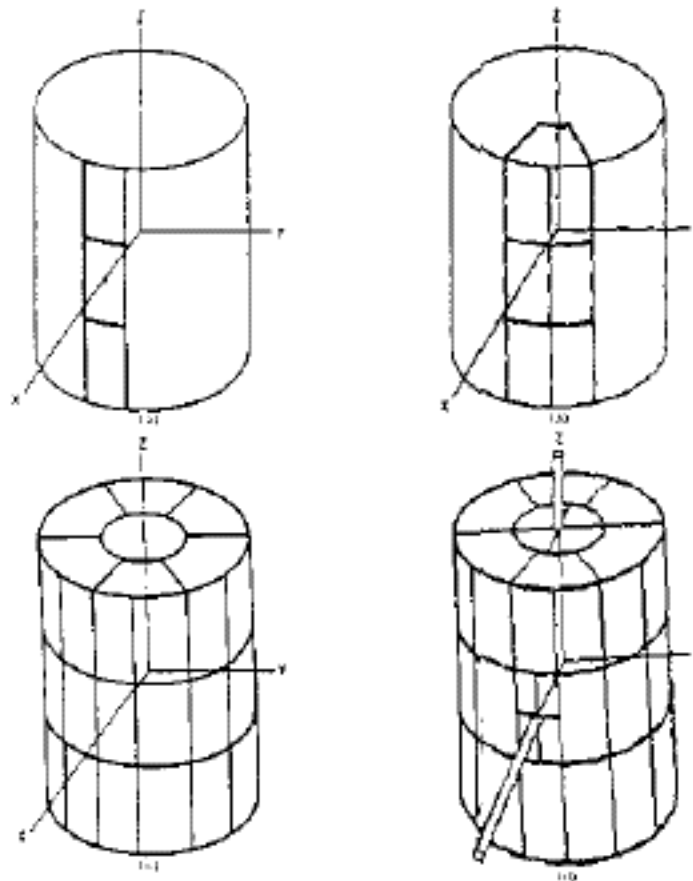

Figure 12. Development of Surface Model for Cylinder with Attached Wires.

Geometry Data Cards:

SP		10.	0.	7.3333	0.	0.	38.4	
SP		10.	0.	0.	0.	0.	38.4	
SP		10.	0.	7.3333	0.	0.	38.4	
GM	1	0.	0.	30.				
SP		6.89	0.	11.	90.	0.	44.89	
SP		6.89	0.	11.	90.	0.	44.89	
GR	6							
SP		0.	0.	11.	90.	0.	44.89	
SP		0.	0.	11.	90.	0.	44.89	
GW	4	0.	0.	11.	0.	0.	23.	.1
GW	5	10.	0.	0.	27.6	0.	0.	.2
GS		.01						
GE								

Number of Segments: 9

Number of Patches: 56

Symmetry: None

The cylinder is generated by first specifying three patches in a column

centered on the X axis as shown in **Figure 12(a)**. A GM card is then used to produce a second column of patches rotated about the Z axis by 30 degrees. A patch is added to the top and another to the bottom to form parts of the end surfaces. The model at this point is shown in **Figure 12(b)**. Next, a GR card is used to rotate this section of patches about the Z axis to form a total of six similar sections, including the original. A patch is then added to the center of the top and another to the bottom to form the complete cylinder shown in **Figure 12(c)**. Finally, two GW cards are used to add wires connecting to the top and side of the cylinder. The patches to which the wires are connected are divided into four smaller patches as shown in **Figure 12(d)**. Although patch shape is not input to the program, square patches are assumed at the base of a connected wire when integrated over the surface current. Hence, a more accurate representation of the model would be as shown in **Figure 13**, where the patches to which wires connect are square with equal areas maintained for all patches (before subdivision).

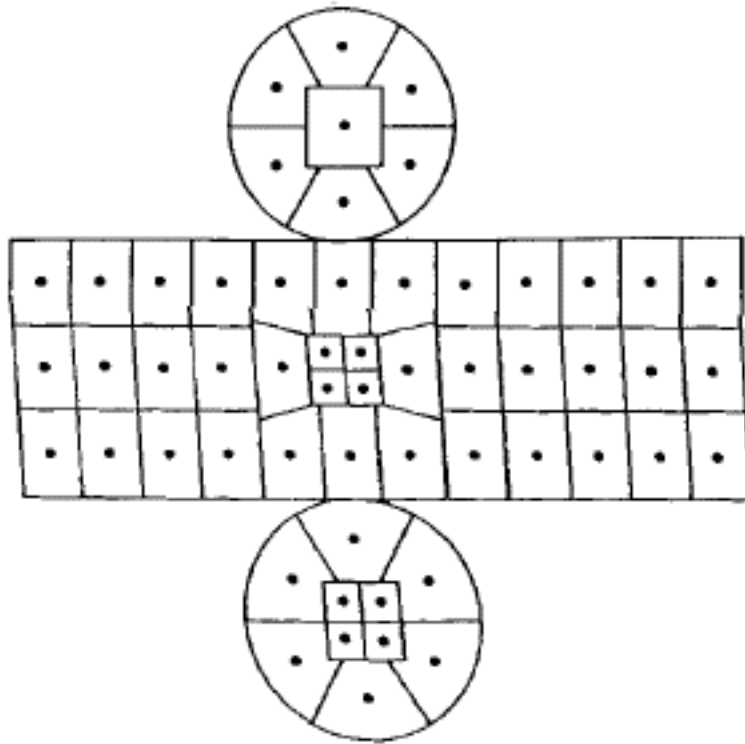

Figure 13. Segmentation of cylinder for wires connected to end and side.

3. Program Control Cards

The program control cards follow the structure geometry cards. They set electrical parameters for the model, select options for the solution procedure, and request data computation. The cards are listed below by their mnemonic identifier with a brief description of their function:

Group I	EK - extended thin-wire kernel flag FR - frequency specification GN - ground parameter specification KH - interaction approximation range LD - structure impedance loading
Group II	EX - structure excitation card NT - two-port network specification TL - transmission line specification
Group III	CP - coupling calculation EN - end of data flag GD - additional ground parameter specifications NE - near electric field request NH - near magnetic field request NX - next structure flag PQ - wire charge density print control PT - wire-current print control RP - radiation pattern request WG - write Numerical Green's Function file XQ - execute card

There is no fixed order for the cards. The desired parameters and options are set first followed by requests for calculation of currents, near fields and radiated fields. Parameters that are not set in the input data are given default values. The one exception to this is the excitation (EX) which must be set.

Computation of currents may be requested by an XQ card. RP, NE, or NH cards cause calculation of the currents and radiated or near fields on the first occurrence. Subsequent RP, NE, or NH cards cause computation of fields using the previously calculated currents. Any number of near-field and radiation-pattern requests may be grouped together in a data deck. An exception to this occurs when multiple frequencies are requested by a single FR card. In this case, only a single NE or NH card and a single RP card will remain in effect for all frequencies.

All parameters retain their values until changed by subsequent data cards. Hence, after parameters have been set and currents or fields computed, selected parameters may be changed and the calculations repeated. For example, if a number of different excitations are required at a single frequency, the deck could have the form FR, EX, XQ, EX, XQ,.... If a single excitation is required at a number of frequencies, the cards EX, FR, XQ, FR, XQ,... could be used.

When the antenna is modified and additional calculations are requested, the order of the cards may, in some cases, affect the solution time since the program will repeat only that part of the solution affected by the changed parameters. For this reason, the user should understand the relation of the data cards to the solution procedure. The first step in the solution is to calculate the interaction matrix, which determines the response of the

antenna to an arbitrary excitation, and to factor this matrix in preparation for solution of the matrix equation. This is the most time-consuming single step in the solution procedure. The second step is to solve the matrix equation for the currents due to a specific excitation. Finally, the near fields or radiated fields may be computed from the currents.

The interaction matrix depends only on the structure geometry and the cards in group I of the program control cards. Thus, computation and factorization of the matrix is not repeated if cards beyond group I are changed. On the other hand, antenna currents depend on both the interaction matrix and the cards in group II, so that the currents must be recomputed whenever cards in group I or II are changed. The near fields depend only on the structure currents while the radiated fields depend on the currents and on the GD card, which contains special ground parameters for the radiated-field calculation. An example of the implications of these rules is presented by the following two sets of data cards:

```
FR, EX, NT1, LD1, XQ, LD2, XQ, NT2, LD1, XQ, LD2, XQ
```

```
FR, EX, LD1, NT1, XQ, NT2, XQ, LD2, NT1, XQ, NT2, XQ
```

Calculation and factoring of the matrix would be required four times by the first set but only twice by the second set in obtaining the same information.

The program control cards are explained on the following pages. The format of all program control cards has four integers and six floating point numbers. The integers are contained in columns 3 through 5, 6 through 10, 11 through 15, and 16 through 20 (each integer field stops at an integral multiple of 5 columns), and the floating point numbers are contained in fields of 10 for the remainder of the card (i.e., from 21 through 30, 31 through 40, etc.). Integers are right justified in their fields. The floating point numbers can be punched either as a string of digits containing a decimal point, punched anywhere in the field; or as a string of digits containing a decimal point and followed by an exponent of ten in the form $E \pm I$ which multiplies the number by $10^{\pm I}$. The integer exponent must be right-justified in the field.

Maximum Coupling Calculation (CP)

Purpose: To request calculation of the maximum coupling between segments.

Card:

	/2	5	10	15	20	30	40	50	60	70	80
/	CP	I1	I2	I3	I4	blank	blank	blank	blank	blank	blank
		T	S	T	S						
		A	E	A	E						
		G	G	G	G						
		1	1	2	2						
	The numbers along the top refer to the last column in each field.										

Parameters:

- TAG1 (I1) Specify segment number SEG1 in th set of segments
- SEG1 (I2) having tag TAG1. If TAG1 is blank or zero, then
SEG1 is the segment number.
- TAG2 (I3) Same as above.
- SEG2 (I4) Same as above.

Notes:

- * Up to five segments may be specified on 2-1/2 CP cards. Coupling is computed between all pairs of these segments. When more than two segments are specified, the CP cards must be grouped together. A new group of CP cards replaces the old group.
- * CP does not cause the program to proceed with the calculation but only sets the segment numbers. The specified segments must then be excited (EX card) one at a time in the specified order and the currents computed (XQ, RP, NE, or NH card). The excitation must use the applied-field voltage-source model. When all of the specified segments have been excited in the proper order, the couplings will be computed and printed. After the coupling calculation the set of CP cards is canceled.

Extended Thin-Wire Kernel (EK)

Purpose: To control use of the extended thin-wire kernel approximation.

Card:

	/2	5	10	15	20	30	40	50	60	70	80
EK	I1					blank	blank	blank	blank	blank	blank
	I	b	b	b							
	T	l	l	l							
	M	a	a	a							
	P	n	n	n							
	l	k	k	k							
The numbers along the top refer to the last column in each field.											

Parameters:

Integer

ITMP1 (I1) - Blank or zero to initiate use of the extended thin-wire kernel.

-1 to return to the standard thin-wire kernel.

Note:

Without an EK card, the program will use the standard thin-wire kernel.

End of Run (EN)

Purpose: To indicate to the program the end of all execution.

Card:

/2	5	10	15	20	30	40	50	60	70	80
EN					blank	blank	blank	blank	blank	blank
	b	b	b	b						
	l	l	l	l						
	a	a	a	a						
	n	n	n	n						
	k	k	k	k						
The numbers along the top refer to the last column in each field.										

Parameters: None

Excitation (EX)

Purpose: To specify the excitation for the structure. The excitation can be voltage sources on the structure, an elementary current source, or a plane wave incident on the structure.

Card:

	/2	5	10	15	20	30	40	50	60	70	80
	/										
	EX	I1	I2	I3	I4	F1	F2	F3	F4	F5	F6
	The numbers along the top refer to the last column in each field.										

Parameters:

Integers

- I1 determines the type of excitation which is used:
 - 0 - voltage source (applied-E-field source).
 - 1 - incident plane wave, linear polarization.
 - 2 - incident plane wave, right-hand (thumb along the incident k-vector) elliptic polarization.
 - 3 - incident plane wave, left-hand elliptic polarization.
 - 4 - elementary current source.
 - 5 - voltage source (current-slope-discontinuity).

Remaining Integers Depend on Excitation Type

a. Voltage source (I1 = 0 or 5)

I2 = tag number of the source segment. This tag number along with the number to be given in (I3), which identifies the position of the segment in a set of equal tag numbers, uniquely defines the source segment. Blank or zero in field (I2) implies that the source segment will be identified by using the absolute segment number in the next field.

I3 = m, specifies the mth segment of the set of segments whose tag numbers are equal to the number set by the previous parameter. If the previous parameter is zero, the number in (I3) must be the absolute segment number of the source.

I4 - Columns 19 and 20 of this field are used separately. The options for column 19 are:

- 1 - maximum relative admittance matrix asymmetry for source segment and network connection will be calculated and printed.
- 0 - no action.

The options for column 20 are:

- 1 - the input impedance at voltage sources is always printed directly before the segment currents in the output. By setting this flag, the impedance of a single source segment in a frequency loop will be collected and printed in a table (in a normalized and an unnormalized form) after the information at all frequencies has been printed. Normalization to the maximum value is a default, but the normalization value can be specified (refer to F3 under voltage source below). When there is more than one source on the structure, only the impedance of the last Source specified will be collected.
 - 0 - no action
- b. Incident plane wave (I1 = 1, 2, or 3)
- (I2) - Number of theta angles desired for the incident plane wave .
 - (I3) - Number of phi angles desired for the incident plane wave.
 - (I4) - Only column 19 is used. The options are:
 - 1 - maximum relative admittance matrix asymmetry for network connections will be calculated and printed.
 - 0 - no action
- c. Elementary current source (I1 = 4)
- (I2) & (I3) - blank.
 - (I4) - Only column 19 is used and its function is identical to that listed under b.

Floating Point Options

- a. Voltage source (I1 = 0 or 5)
- (F1) - Real part of the voltage in volts.
 - (F2) - Imaginary part of the voltage in volts. (F3) - If a one is placed in column 20 (see above), this field can be used to specify a normalization constant for the impedance printed in the optional impedance table. Blank in this field produces normalization to the maximum value.
 - (F4), (F5), & (F6) - Blank.
- b. Incident plane wave (I1 = 1, 2, or 3). The incident wave is characterized by the direction of its \hat{k} vector, and by an angle of polarization in the plane normal to \hat{k} .
- (F1) - Theta (θ) in degrees. Theta is a standard spherical coordinate, measured from the Z-axis as illustrated in **Figure 14**.

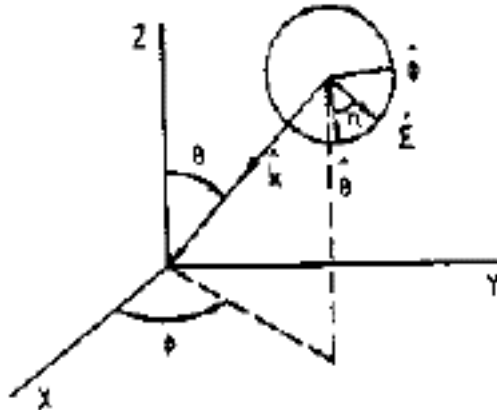

Figure 14. Specification of Incident Wave.

(F2) - Phi (ϕ) in degrees. Phi is the standard spherical angle defined in the XY plane, measured around the Z-axis.

(F3) - Eta (η) in degrees. Eta is a polarization angle, defined as the angle between the theta-directed unit vector and the electric-field (E) vector for linear polarization, or the major ellipse axis for elliptical polarization. Refer to **Figure 14**.

(F4) - Theta angle stepping increment in degrees.

(F5) - Phi angle stepping increment in degrees.

(F6) - Ratio of minor axis to major axis for elliptic polarization.

C. Elementary current source ($I_1 = 4$). The current source is characterized by its Cartesian coordinate position, orientation, and its magnitude.

(F1) - X position in meters.

(F2) - Y position in meters.

(F3) - Z position in meters.

(F4) - Alpha (α) in degrees. Alpha is the angle the current source makes with the XY plane, as illustrated in **Figure 15**.

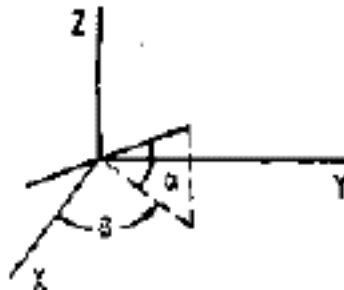

Figure 15. Orientation of Current Element.

- (F5) - Beta (β) in degrees. Beta is the angle that the projection of the current source on the XY plane makes with the X axis, as illustrated in **Figure 15**.
- (F6) - "Current moment" of the source. This parameter is equal to the product [OCR GARBLE] in amp-meters.

Notes:

- * In the case of voltage sources, excitation cards can be grouped together in order to specify multiple sources. The maximum number of voltage sources that may be specified is determined by dimension statements in the program. The dimensions are set for 10 applied-E-field voltage sources and 10 current-slope-discontinuity voltage sources.
- * An applied-E-field voltage source is located on the segment specified.
- * A current-slope-discontinuity source is located at the first end, relative to the reference direction, of the specified segment, at the junction between the specified segment and the previous segment. This junction must be a simple two-segment junction. and the two segments must be parallel with equal lengths and radii.
- * A current-slope-discontinuity voltage source may lie in a symmetry plane. An applied field voltage source may not lie in a symmetry plane since a segment may not lie in a symmetry plane. An applied-field voltage source may be used on a wire crossing a symmetry plane by exciting the two segments on opposite sides of the symmetry plane each with half the total voltage, taking account of the reference directions of the two segments.
- * An applied-field voltage source specified on a segment which has been impedance-loaded, through the use of an LD card, is connected in series with the loads. An applied-field voltage source specified on the same segment as a network is connected in parallel with the network port. For the specific case of a transmission line, the source is in parallel with both the line and the shunt load. Applied-field voltage sources should be used in these cases since loads and network connections are located on, rather than between, segments.
- * Only one incident plane-wave or one elementary current source is allowed at a time. Also, plane-wave or current-source excitation is not allowed with voltage sources. If the excitation types are mixed, the program will use the last excitation type encountered.
- * When a number of theta and phi angles are specified for an incident plane-wave excitation, the theta angle changes more rapidly than phi.
- * The current element source illuminates the structure with the field of an infinitesimal current element at the specified location. The current element source cannot be used over a ground plane.

Frequency (FR)

Purpose: To specify the frequency (frequencies) in MegaHertz.

Card:

/2	5	10	15	20	30	40	50	60	70	80
FR	I1	I2	I3	I4	F1	F2	F3	F4	F5	F6
	I	N	B	B	FMHZ	DELFRQ	BLANK	BLANK	BLANK	BLANK
	F	F	L	L						
	R	R	A	A						
	Q	Q	N	N						
			K	K						
The numbers along the top refer to the last column in each field.										

Parameters:

Integers

- IFRQ (I1) - Determines the type of frequency stepping:
0 - linear stepping.
1 - multiplicative stepping.
- NFRQ (I2) - Number of frequency steps. If this field is blank, one is assumed.
- (I3), (I4) - Blank.

Floating Point

- FMHZ (F1) - Frequency in MegaHertz.
- DELFRQ (F2) - Frequency stepping increment. If the frequency stepping is linear, this quantity is added to the frequency each time. If the stepping is multiplicative, this is the multiplication factor.
- (F3)...(F6) - Blank.

Notes:

- * If a frequency card does not appear in the data deck, a single frequency of 299.8 MHz is assumed. Since the wavelength at 299.8 MHz is one meter, the geometry is in units of wavelengths for this case.
- * Frequency cards may not be grouped together. If they are, only the information on the last card in the group will be used.
- * After an FR card with NFRQ greater than 1, an NE or SH card will not initiate execution, while an RP or XQ card will. In this case, only one NE or WH card and one RP card will be effective for the multiple frequencies.
- * After a frequency loop for NFRQ > 1 has been completed, it will not be repeated for a second execution request. The FR card must be repeated in this case.

Additional Ground Parameters (GD)

Purpose: To specify the ground parameters of a second medium which is not in the immediate vicinity of the antenna. This card may only be used if a GN card has also been used. It does not affect the fields of surface patches.

Card:

	/2	5	10	15	20	30	40	50	60	70	80
GD	I1	I2	I3	I4	F1	F2	F3	F4	F5	F6	
	B	B	B	B	E	S	CLT	CHT	B	B	
	L	L	L	L	P	I			L	L	
	A	A	A	A	S	G			A	A	
	N	N	N	N	R	2			N	N	
	K	K	K	K	2				K	K	

The numbers along the top refer to the last column in each field.

Parameters:

Integers

All integer fields are blank.

Floating Point

EPSR2 (F1) - Relative dielectric constant of the second medium.

SIG2 (F2) - Conductivity in mhos/meter of the second medium.

CLT (F3) - Distance in meters from the origin of the coordinate system to the join between medium 1 and 2. This distance is either the radius of the circle where the two media join or the distance out the +X axis to where the two media join in a line parallel to the Y axis. Specification of the circular or linear option is on the RP card. See **Figure 16**.

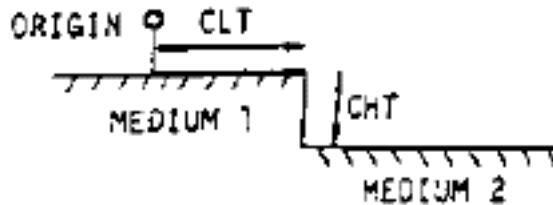

Figure 16. Parameters for a second Ground Medium

CHT (F4) - Distance in meters (positive or zero) by which the surface of medium 2 is below medium 1.

(FS) & (F6) - Blank.

Notes:

- * The GD card can only be used in a data set where the GN card has been used, since the GN card is the only way to specify the ground parameters in the vicinity of the antenna (see GN card write-up). However, a number of GD cards may be used in the same data set with only one GN card.
- * GD cards may not be grouped together. If they are, only the information on the last card of the group is retained.
- * When a second medium is specified, a flag must also be set on the radiation pattern (RP) data card in order to calculate the patterns including the effect of the second medium. Refer to the radiation-pattern card write-up for details.
- * Use of the GD card does not require recalculation of the matrix or currents.
- * The parameters for the second medium are used only in the calculation of the far fields. It is possible then to set the radius of the boundary between the two media equal to zero and thus have the far fields calculated by using only the parameters of medium 2. The currents for this case will still have been calculated by using the parameters of medium 1.
- * When a model includes surface patches, the fields due to the patches will be calculated by using only the primary ground parameters. Hence, a second ground medium should not be used with patches.

Ground Parameters (GN)

Purpose: To specify the relative dielectric constant and conductivity of ground in the vicinity of the antenna. In addition, a second set of ground parameters for a second medium can be specified, or a radial wire ground screen can be modeled using a reflection coefficient approximation.

Card:

	/2	5	10	15	20	30	40	50	60	70	80
/	GN	I1	I2	I3	I4	F1	F2	F3	F4	F5	F6
		I	N	b	b	E	S				
		P	R	l	l	P	I				
		E	A	a	a	S	G				
		R	D	n	n	E					
		F	L	k	k						
The numbers along the top refer to the last column in each field.											

Parameters:

Integers

- IPERF (I1) - Ground-type flag. The options are:
 - 1 - nullifies ground parameters previously used and sets free-space condition. The remainder of the card is left blank in this case.
 - 0 - finite ground, reflection-coefficient approximation.
 - 1 - perfectly conducting ground.
 - 2 - finite ground, Sommerfeld/Norton method.
- NRADL (I2) - Number of radial wires in the ground screen approximation; blank or 0 implies no ground screen.
- (I3) & (I4) - Blank.

Floating Point:

- EPSE (F1) - Relative dielectric constant for ground in the vicinity of the antenna. Leave blank in case of a perfect ground.
- SIG (F2) - Conductivity in mhos/meter of the ground in the vicinity of the antenna. Leave blank in the case of a perfect ground. If SIG is input as a negative number, the complex dielectric constant $\epsilon_c = \epsilon_r - j \cdot \sigma / (\omega \cdot \epsilon_0)$ is set to $\epsilon_{PSR} - |\text{SIG}|$.

Options for Remaining Floating Point Fields (F3-F6):

- a. For an infinite ground plane, F3 through F6 are blank.
- b. Radial wire ground screen approximation (NRADL nonzero). The ground screen is always centered at the origin, i.e., at (0,0,0), and lies in the XY plane.
 - (F3) - The radius of the screen in meters.
 - (F4) - Radius of the wires used in the screen, in meters.
 - (F5) & (F6) - Blank.

c. Second medium parameters (NRADL = 0) for medium outside the region of the first medium (cliff problem). These parameters alter the far field patterns but do not affect the antenna impedance or current distribution.

(F3) - Relative dielectric constant of medium 2.

(F4) - Conductivity of medium 2 in mhos/meter.

(F5) - Distance in meters from the origin of the coordinate system to the join between medium 1 and 2. This distance is either the radius of the circle where the two media join or the distance out the positive X axis to where the two media join in a line parallel to the Y axis. Specification of the circular or linear option is on the RP card. See **Figure 16**.

(F6) - Distance in meters (positive or zero) by which the surface of medium 2 is below medium 1.

Notes:

- o When the Sommerfeld/Norton method is used, NEC requires an input-data file (TAPE21) that is generated by the program SOMNEC for the specific ground parameters and frequency (see section III-4). The file generated by SOMNEC depends only on the complex dielectric constant, $E_c = E_r - j \cdot \sigma / (\omega \cdot \epsilon_0)$. NEC compares E_c from the file with that determined by the GN card parameters and frequency. If the relative difference exceeds 10^{-3} , an error message is printed. Once TAPE21 has been read for the first use of the Sommerfeld/Norton method, the data is retained until the end of the run. Subsequent data, including new data sets following XQ[?] cards, may use the TAPE21 data if the ground parameters and frequency (thus, E_c) remain unchanged. Other ground options may be intermixed with the Sommerfeld/Norton option.
- o The parameters of the second medium can also be specified on another data card whose mnemonic is GD. With the GD card, the parameters of the second medium can be varied and only the radiated fields need to be recalculated. Furthermore, if a radial wire ground screen has been specified on the GN card, the GD card is the only way to include a second medium. See the write-up of the GD card for details.
- o GN cards may not be grouped together. If they are, only the information on the last card will be retained.
- o Use of a GN card after any form of execute dictates structure matrix regeneration.
- o Only the parameters of the first medium are used when the antenna currents are calculated; the parameters associated with the second medium are not used until the calculation of the far fields. It is possible then to calculate the currents over one set of ground parameters (medium one), but to calculate the far fields over another set (medium two) by setting the distance to the start of medium two to zero. Medium one can even be a perfectly conducting ground specified by IPERF=1.
- o When a radial wire ground screen or a second medium is specified, it is necessary to indicate their presence by the first parameter on the RP card in order to generate the proper radiation patterns.
- o When a ground plane is specified, this fact should also be indicated on the GE card. Refer to the GE card for details.
- o When a model includes surface patches, the fields due to the patches will be calculated by using only the primary ground parameters. Hence, a second ground medium should not be used with patches. The radial wire ground screen approximation also is not implemented for patches.

Interaction Approximation Range (KH)

Purpose: To set the minimum separation distance for use of a time-saving approximation in filling the interaction matrix.

Card:

	/2	5	10	15	20	30	40	50	60	70	80
KH	I1	I2	I3	I4	F1	F2	F3	F4	F5	F6	
	B	RKH	B	B	B	B	B	B	B	B	B
	L		L	L	L	L	L	L	L	L	L
	A		A	A	A	A	A	A	A	A	A
	N		N	N	N	N	N	N	N	N	N
	K		K	K	K	K	K	K	K	K	K
The numbers along the top refer to the last column in each field											

Parameters:

Integers - None

Decimal Numbers

RKH (F1) - The approximation is used for interactions over distances greater than RKH wavelengths.

Notes:

- * If two segments or a segment and a patch are separated by more than RKH wavelengths, the interaction field is computed from an impulse approximation to the segment current. The field of a current element located at the segment center is used. No approximation is used for the field due to the surface current on a patch since the time for the standard calculation is very short.
- * The KH card can be placed anywhere in the data cards following the geometry cards (with FR, EX, LD, etc.) and affects all calculations requested following its occurrence. The value of RKH may be changed within a data set by use of a new KH card.

Loading (LD)

Purpose: To specify the impedance loading on one segment or a number of segments. Series and parallel RLC circuits can be generated. In addition, a finite conductivity can be specified for segments.

Card:

	/2	5	10	15	20	30	40	50	60	70	80
LD	I1	I2	I3	I4	F1	F2	F3	F4	F5	F6	
	L	L	L	L	ZLR	ZLI	ZLC	B	B	B	
	D	D	D	D				L	L	L	
	T	T	T	T				A	A	A	
	Y	A	A	A				N	N	N	
	P	G	G	G				K	K	K	
			F	T							
The numbers along the top refer to the last column in each field.											

Parameters:

Integers:

LDTYP (I1) - Determines the type of loading which is used. The options are:

- 1 - short all loads (used to nullify previous loads). The remainder of the card is left blank.
- 0 - series RLC, input ohms, henries, farads.
- 1 - parallel RLC, input ohms, henries, farads.
- 2 - series RLC, input ohms/meter, henries/meter, farads/meter.
- 3 - parallel RLC, input ohms/meter, henries/meter, farads/meter.
- 4 - impedance, input resistance and reactance in ohms.
- 5 - wire conductivity, mhos/meter.

LDTAG (I2) Tag number; identifies the wire section(s) to be loaded by its (their) tag numbers. The next two parameters can be used to further specify certain segment(s) on the wire section(s). Blank or zero here implies that absolute segment numbers are being used in the next two parameters to identify segments. If the next two parameters are blank or zero, all segments with tag LDTAG are loaded.

LDTAGF (I3) - Equal to m specifies the mth segment of the set of segments whose tag numbers equal the tag number specified in the previous parameter. If the previous parameter (LDTAG) is zero, LDTAGF then specifies an absolute segment number. If both LDTAG and LDTAGF are zero, all segments will be loaded.

LDTAGT (I4) - Equal to n specifies the nth segment of the set of segments whose tag numbers equal the tag number specified in the parameter LDTAG. This parameter must be greater than or equal to the previous parameter. The loading specified is applied to each of the mth through nth segments of the set of segments having tags

equal to LDTAG. Again if LDTAG is zero, these parameters refer to absolute segment numbers. If LDTAGT is left blank, it is set equal to the previous parameter (LDTAGF).

Floating Point Input for the Various Load Types

- a. Series RLC (LDTYP = 0)
 - ZLR (F1) - Resistance in ohms; if none, leave blank.
 - ZLI (F2) - Inductance in henries; if none, leave blank.
 - ZLC (F3) - Capacitance in farads; if none, leave blank.
- b. Parallel RLC (LDTYP = 1), floating point input same as a.
- c. Series RLC (LDTYP = 2) input parameters per unit length.
 - ZLR - Resistance in ohms/meter; if none, leave blank.
 - ZLI - Inductance in henries/meter; if none, leave blank.
 - ZLC - Capacitance in farads/meter; if none, leave blank.
- d. Parallel RLC (LDTYP = 3), input parameters per unit length, floating-point input same as c.
- e. Impedance (LDTYP = 4)
 - ZLR - Resistance in ohms.
 - ZLI - Reactance in ohms.
- f. Wire conductivity (LDTYP = 5)
 - ZLR - Conductivity in mhos/meter.

Notes:

- * Loading cards can be input in groups to achieve a desired structure loading. The maximum number of loading cards in a group is determined by dimensions in the program. The limit is presently 30.
- * If a segment is loaded more than once by a group of loading cards, the loads are assumed to be in series (impedances added), and a comment is printed in the output alerting the user to this fact.
- * When resistance and reactance are input (LDTYP = 4), the impedance does not automatically scale with frequency.
- * Loading cards used after any form of execute, require regeneration of the structure matrix.
- * Since loading modifies the interaction matrix, it will affect the conditions of plane or cylindrical symmetry of a structure. If a structure is geometrically symmetric and each symmetric section is to receive identical loading, then symmetry may be used in the solution. The program is set to utilize symmetry during geometry input by inputting the data for one symmetric section and completing the structure with a GR or GX card. If symmetry is used, the loading on only the first symmetric section is input on LD cards. The same loading will be assumed on the other sections. Loading should not be specified for segments beyond the first section when symmetry is used. If the sections are not identically loaded, then during geometry input the program must be set to a no-symmetry condition to permit independent loading of corresponding segments in different sections.

Near Fields (NE, NH)

Purpose: To request calculation of near electric fields in the vicinity of the antenna (NE) or to request near magnetic fields (NH).

Card:

Cols.	Parameter
1- 2	NE or NH
3- 5	I1 NEAR
6-10	I2 NRX
11-15	I3 NRY
16-20	I4 NRZ
21-30	F1 XNR
31-40	F2 YNR
41-50	F3 ZNR
51-60	F4 DXNR
61-70	F5 DYNR
71-80	F6 DZNR

Parameters:

Integer fields:

NEAR (I1) - Coordinate system type. The options are:
 0 - rectangular coordinates will be used.
 1 - spherical coordinates will be used.

Remaining Integers Depend on Coordinate Type:

- a. Rectangular coordinates (NEAR = 0)
 - NRX (I2) - Number of points desired in the X, Y, and Z directions respectively. X changes the most rapidly, then Y, and then Z. The value 1 is assumed for any field left blank.
 - NRY (I3)
 - NRZ (I4)
- b. Spherical coordinates (NEAR = 1)
 - (I2) - Number of points desired in the r, phi, and theta directions, respectively. r changes the most rapidly, then phi, and then theta. The value 1 is assumed for any field left blank.
 - (I3)
 - (I4)

Floating-Point Fields:

Their specification depends on the coordinate system chosen.

- a. Rectangular coordinates (NEAR = 0)
 - XNR (F1) - The (X, Y, Z) coordinate position (F1, F2, F3) respectively, in meters of the first field point.
 - YNR (F2)
 - ZNR (F3)
 - DXNR (F4) - Coordinate stepping increment in meters for the X, Y, and Z coordinates (F4, F5, F6), respectively.
 - DYNR (F5)
 - DZNR (F6) - In stepping, X changes most rapidly, then Y, and then Z.
- b. Spherical coordinates (NEAR = 1)
 - (F1) - The (r, phi, theta) coordinate position (F1, F2, F3) respectively, of the first field point. r is in meters, and phi and theta are in degrees.
 - (F2)
 - (F3)

- (F4) - Coordinate stepping increments for r, phi, and theta
- (F5) - (F4, F5, F6), respectively. The stepping increment
- (F6) - for r is in meters, and for phi and theta is in degrees.

Notes:

- * When only one frequency is being used, near-field cards may be grouped together in order to calculate fields at points with various coordinate increments. For this case, each card encountered produces an immediate execution of the near-field routine and the results are printed. When automatic frequency stepping is being used [*i.e.*, when the number of frequency steps (NFRQ) on the FR card is greater than one], only one NE or NH card can be used for program control inside the frequency loop. Furthermore, the NE or NH card does not cause an execution in this case. Execution will begin only after a subsequent radiation-pattern card (RP) or execution card (XQ) is encountered (see respective write-ups on both of these cards).
- * The time required to calculate the field at one point is equivalent to filling one row of the matrix. Thus, if there are N segments in the structure, the time required to calculate fields at N points is equivalent to the time required to fill an N x N interaction matrix.
- * The near electric field is computed by whichever form of the field equations was selected for filling the matrix, either the thin-wire approximation or extended thin-wire approximation. At large distances from the structure, the segment currents are treated as infinitesimal current elements.
- * If the field calculation point falls within a wire segment, the point is displaced by the radius of that segment in a direction normal to the plane containing each source segment and the vector from that source segment to the observation segment. When the specified field-calculation point is at the center of a segment, this convention is the same as is used in filling the interaction matrix. If the field point is on a segment axis, that segment produces no contribution to the H-field or the radial component of the E-field. If these components are of interest, the field point should be on or outside of the segment surface.

Networks (NT)

Purpose:

To generate a two-port nonradiating, network connected between any two segments in the structure. The characteristics of the network are specified by its short-circuit admittance matrix elements. For the special case of a transmission line, a separate card is provided for convenience although the mathematical method is the same as for networks. Refer to the TL card.

Card:

/2	5	10	15	20	30	40	50	60	70	80
NT	I1	I2	I3	I4	F1	F2	F3	F4	F5	F6
					Y11R	Y11I	Y12R	Y12I	Y22R	Y22I
The numbers along the top refer to the last column in each field.										

Parameters:

Integers

(I1) - Tag number of the segment to which port one of the network is connected. This tag number along with the number to be given in (I2), which identifies the position of the segment in a set of equal tag numbers, uniquely defines the segment for port one. Blank or zero here implies that the segment will be identified using the absolute segment number in the next location (I2).

(I2) - Equal to m, specifies the mth segment of the set of segments whose tag numbers are equal to the number set by the previous parameter. If the previous parameter is zero, the number in (I2) is the absolute segment number corresponding to end one of the network. A minus one in this field will nullify all previous network and transmission-line connections. The rest of the card is left blank in this case.

(I3) & (I4) - Used in exactly the same way as (I1) & (I2) in order to specify the segment corresponding to port two of the network connection.

Floating point:

The six floating-point fields are used to specify the real and imaginary parts of three short circuit admittance matrix elements (1, 1), (1, 2), and (2, 2), respectively. The admittance matrix is symmetric so it is unnecessary to specify element (2, 1).

- Y11R (F1) - Real part of element (1, 1) in mhos.
- Y11I (F2) - Imaginary part of element (1, 1) in mhos.
- Y12R (F3) - Real part of element (1, 2) in mhos.

- Y12I (F4) - Imaginary part of element (1, 2) in mhos.
- Y22R (F5) - Real part of element (2, 2) in mhos.
- Y22I (F6) - Imaginary part of element (2, 2) in mhos.

Notes:

- * Network cards may be used in groups to specify several networks on a structure. All network cards for a network configuration must occur together with no other cards (except TL cards) separating them. When the first NT card is read following a card other than an NT or TL card, all previous network and transmission line data are destroyed. Hence, if a set of network data is to be modified, all network data must be input again in the modified form. Dimensions in the program limit the number of networks that may be specified. In the present NEC deck, the number of two-port networks (including transmission lines) is limited to thirty, and the number of different segments having network ports connected to them is limited to thirty.
- * One or more network ports can be connected to any given segment. Multiple network ports connected to one segment are connected in parallel.
- * If a network is connected to a segment which has been impedance loaded (i.e., through the use of the LD card), the load acts in series with the network port.
- * A voltage source specified on the same segment as a network port is connected in parallel with the network port.
- * Segments can be impedance-loaded by using network cards. Consider a network connected from the segment to be loaded to some other arbitrary segment as shown in **Figure 17**.

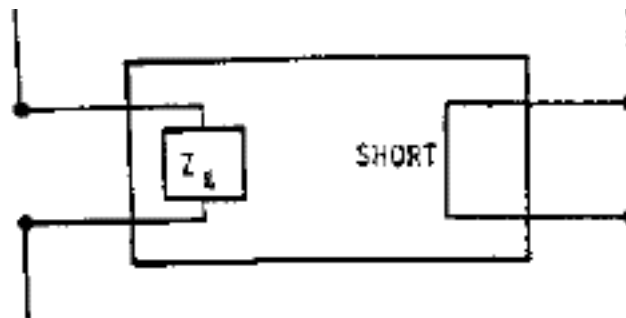

Figure 17. Segment Loaded by Means of a 2-Port Network.

The admittance matrix elements are $Y_{11} = 1/Z_L$, $Y_{12} = 0$, and $Y_{22} = \text{infinity}$ (computationally, a very large number such as 10^{10}). The advantage of using this technique for loading is that the load can be changed without causing a recalculation of the structure matrix as is required when LD cards are used. Furthermore, in some cases a higher degree of structure matrix symmetry can be preserved because the matrix elements are not directly modified by networks as they are when using the LD cards. (Consider for instance a loop with one load where the loop is rotationally symmetric until the load is placed on it.) The disadvantage of the NT card form of loading is that the user must calculate the load admittance, and this value does not automatically scale with frequency. Obviously, in the above schematic, replacing the short with an impedance would load two

segments. At a segment at which a voltage source is specified, the effect of loading by the LD and NT cards differs, however, since the network is in parallel with the voltage source while the load specified by an LD card is in series with the source.

- * Use of network cards (NT) after any form of execute requires recalculation of the current only.
- * NT and TL cards do not affect structure symmetry.

Next Structure (NX)

Purpose: To signal the end of data for one structure and the beginning of data for the next.

Card:

/2	5	10	15	20	30	40	50	60	70	80
NX	I1	I2	I3	I4	F1	F2	F3	F4	F5	F6
The numbers along the top refer to the last column in each field.										

Parameters:

NX appears in the first two columns, and the rest of the card is blank.

Notes:

The card that directly follows the NX card must be a comment card CM.

Print Control For Charge on Wires (PQ)

Card:

/2	5	10	15	20	30	40	50	60	70	80
PQ	I1	I2	I3	I4	F1	F2	F3	F4	F5	F6
	I P T F L Q									
The numbers along the top refer to the last column in each field.										

Parameters:

Integers

IPTFLQ (I1) - Print control flag [Note "Q" not "G".]

-1 - suppress printing of charge densities. This is the default condition.

0 - (or blank) print charge densities on segments specified by the following parameters. If the following parameters are blank, charge densities are printed for all segments.

IPTAQ (I2) - Tag number of the segments for which charge densities will be printed.

IPTAQF (I3) - Equal to m specifies the mth segment of the set of segments having tag numbers of IPTAQ. If IPTAQ is zero or blank, then IPTAQF refers to an absolute segment number. If IPTAQF is left blank, then charge density is printed for all segments.

IPTAQT (I4) - Equal to n, specifies the nth segment of the set of segments having tag numbers of IPTAQ. Charge densities are printed for segments having tag number IPTAQ starting at the mth segment in the set and ending at the nth segment. If IPTAQ is zero or blank, then IPTAQF and IPTAQT refer to absolute segment numbers. If IPTAQT refer to absolute segment numbers. If IPTAQT is left blank, it is set equal to IPTAQF.

Page Title / Print Control for Current on Wires (PT)

Purpose: To control the printing of currents on wire segments. Current printing can be suppressed, limited to a few segments, or special formats for receiving patterns can be requested.

Card:

/2	5	10	15	20	30	40	50	60	70	80
/										
PT	I1	I2	I3	I4	F1	F2	F3	F4	F5	F6
The numbers along the top refer to the last column in each field.										

Parameters:

Integers:

IPTFLG (I1) - Print control flag, specifies the type of format used in printing segment currents. The options are:

-2 - all currents printed. This is a default value for the program if the card is omitted.

-1 - suppress printing of all wire segment currents.

0 - current printing will be limited to the segments specified by the next three parameters.

1 - currents are printed by using a format designed for a receiving pattern (refer to output section in this manual). Only currents for the segments specified by the next three parameters are printed.

2 - same as for 1 above; in addition, however, the current for one segment will be normalized to its maximum, and the normalized values along with the relative strength in dB will be printed in a table. If the currents for more than one segment are being printed, only currents from the last segment in the group appear in the normalized table.

3 - only normalized currents from one segment are printed for the receiving pattern case.

IPTAG (I2) - Tag number of the segments for which currents will be printed.

IPTAGF (I3) - Equal to m, specifies the mth segment of the set of segments having the tag numbers of IPTAG, at which printing of currents starts. If IPTAG is zero or blank, then IPTAGF refers to

an absolute segment number. If IPTAGF is blank, the current is printed for all segments.

IPTAGT (I4) - Equal to n specifies the nth segment of the set of segments having tag numbers of IPTAG. Currents are printed for segments having tag number IPTAG starting at the mth segment in the set and ending at the nth segment. If IPTAG is zero or blank, then IPTAGF and IPTAGT refer to absolute segment numbers. In IPTAGT is left blank, it is set to IPTAGF.

Radiation Pattern (RP)

Purpose: To specify radiation pattern sampling parameters and to cause program execution. Options for a field computation include a radial wire ground screen, a cliff, or surface-wave fields.

Card:

/2	5	10	15	20	30	40	50	60	70	80
RP	I1	I2	I3	I4	F1	F2	F3	F4	F5	F6
				"XNDA"						
The numbers along the top refer to the last column in each field.										

Parameters:

Integers

(I1) - This integer selects the mode of calculation for the radiated field. Some values of (I1) will affect the meaning of the remaining parameters on the card. Options available for I1 are:

0 - normal mode. Space-wave fields are computed. An infinite ground plane is included if it has been specified previously on a GN card; otherwise, the antenna is in free space.

1 - surface wave propagating along ground is added to the normal space wave. This option changes the meaning of some of the other parameters on the RP card as explained below, and the results appear in a special output format. Ground parameters must have been input on a GN card.

The following options cause calculation of only the space wave but with special ground conditions. Ground conditions include a two-medium ground (cliff where the media join in a circle or a line), and a radial wire ground screen. Ground parameters and dimensions must be input on a GN or GD card before the RP card is read. The RP card only selects the option for inclusion in the field calculation. (Refer to the GN and GD cards for further explanation.)

2 - linear cliff with antenna above upper level. Lower medium parameters are as specified for the second medium on the GN card or on the GD card.

3 - circular cliff centered at origin of coordinate system: with antenna above upper level. Lower medium parameters are as specified for the second medium on the GN card or on the GD card.

4 - radial wire ground screen centered at origin.

5 - both radial wire ground screen and linear cliff.

6 - both radial wire ground screen and circular cliff.

The field point is specified in spherical coordinates (R , θ , ϕ) as illustrated in **Figure 18**, except when the surface wave is computed. For computing the surface wave field ($I1 = 1$), cylindrical coordinates (ϕ , θ , z) are used to accurately define points near the ground plane at large radial distances. The RP card allows automatic stepping of the field point to compute the field over a region about the antenna at uniformly spaced points. The integers $I2$ and $I3$ and floating point numbers $F1$, $F2$, $F3$ and $F4$ control the field-point stepping.

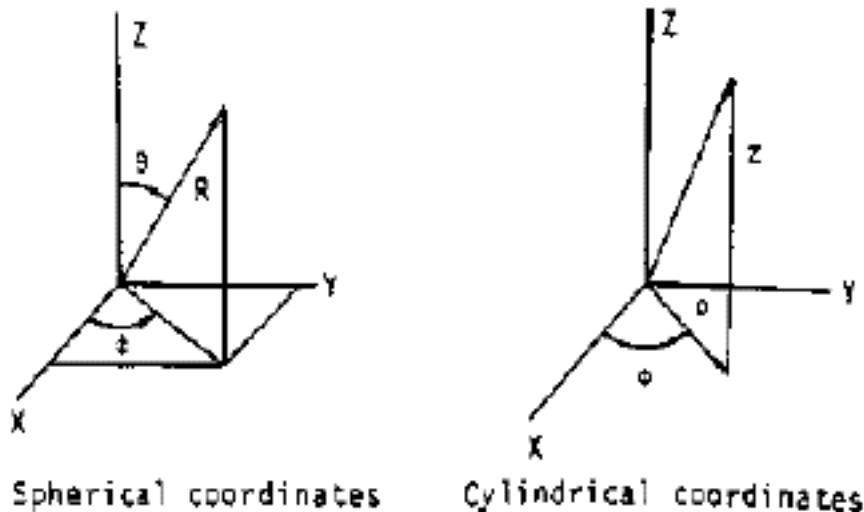

Figure 18. Coordinates for Radiated Field.

NTH ($I2$) - Number of values of θ (θ) at which the field is to be computed (or number of values of z , for $I1 = 1$).

NPH ($I3$) - Number of values of ϕ (ϕ) at which the field is to be computed. The total number of field points requested by the card is $NTH \times NPH$. If $I2$ or $I3$ is left blank, a value of one will be assumed.

XNDA ($I4$) - This optional integer consists of four independent digits in columns 17, 18, 19 and 20, each having a different function. The mnemonic XNDA is not a variable name in the program. Rather, each letter represents a mnemonic for the corresponding digit in $I4$. If $I1 = 1$, then $I4$ has no effect and should be left blank.

X - (column 17) controls output format.

X = 0 major-axis, minor-axis, and total gain printed.

X = 1 vertical, horizontal and total gain printed.

N - (column 18) causes normalized gain for the specified field points to be printed after the standard gain output. The number of field points for which the normalized gain can be printed is

limited by an array dimension in the program. In the demonstration program, the limit is 600 points. If the number of field points exceeds this limit, the remaining points will be omitted from the normalized gain. The gain may be normalized to its maximum or to a value input in field F6. The type of gain that is normalized is determined by the value of N as follows:

- N = 0 no normalized gain.
- = 1 major axis gain normalized.
- = 2 minor axis gain normalized.
- = 3 vertical axis gain normalized.
- = 4 horizontal axis gain normalized.
- = 5 total gain normalized.

D - (column 19) selects either power gain or directive gain for both standard printing and normalization. If the structure excitation is an incident plane wave, the quantities printed under the heading "gain" will actually be the scattering cross section (a/λ^2) and will not be affected by the value of D. The column heading for the output will still read "power" or "directive gain," however.

- D = 0 power gain.
- D = 1 directive gain.

A - (column 20) requests calculation of average power gain over the region covered by field points.

- A = 0 no averaging.
- A = 1 average gain computed.
- A = 2 average gain computed; printing of gain at the field points used for averaging is suppressed. If NTH or NPH is equal to one, average gain will not be computed for any value of A since the area of the region covered by field points vanishes.

Floating Point Numbers

THETS (F1) - Initial theta angle in degrees (initial z coordinate in meters if I1 = 1).

PHIS (F2) - Initial phi angle in degrees.

DTH (F3) - Increment for theta in degrees (increment for z in meters if I1 = 1).

DPH (F4) - Increment for phi in degrees.

RFLD (F5) - Radial distance (R) of field point from the origin in meters. RFLD is optional. If it is blank, the radiated electric field will have the factor $\exp(-jkR)/R$ omitted. If a value of R is specified, it should represent a point in the far-field region since near components of the field cannot be obtained with an RP card. (If I1 = 1, then RFLD represents the cylindrical coordinate phi in meters and is not optional. It must be greater than about one wavelength.)

GNOR (F6) - Determines the gain normalization factor if normalization has been requested in the I4 field. If GNOR is blank or zero, the gain will be normalized to its maximum value. If GNOR is not zero, the gain will be normalized to the value of GNOR.

Notes:

- * The RP card will initiate program execution, causing the interaction matrix to be computed and factored and the structure currents to be computed if these operations have not already been performed. Hence, all required input parameters must be set before the RP card is read.
- * At a single frequency, any number of RP cards may occur in sequence so that different field-point spacings may be used over different regions of space. If automatic frequency stepping is being used (i.e., NFRQ on the FR card is greater than one), only one RP card will act as data inside the loop. Subsequent cards will calculate patterns at the final frequency.
- * When both NTH and NPH are greater than one, the angle theta (or Z) will be stepped faster than phi.
- * When a ground plane has been specified, field points should not be requested below the ground (theta greater than 90 degrees or Z less than zero.)

Transmission Line (TL)

Purpose: To generate a transmission line between any two points on the structure. Characteristic impedance, length, and shunt admittance are the defining parameters.

Card:

Cols.	Parameter

1- 2	TL
3- 5	I1
6-10	I2
11-15	I3
16-20	I4
21-30	F1
31-40	F2
41-50	F3
51-60	F4
61-70	F5
71-80	F6

Parameters:

Integers I1-I4 - (the integer specifications are identical to those on the network (NT) card.)

Floating Point -

(F1) - The characteristic impedance of the transmission line in ohms. A negative sign in front of the characteristic impedance will act as a flag for generating the transmission line with a 180 degree phase reversal (crossed line) if this is desired.

(F2) - The length of transmission line in meters. If this field is left blank, the program will use the straight line distance between the specified connection points.

The remaining four floating-point fields are used to specify the real and imaginary parts of the shunt admittances at end one and two, respectively.

(F3) - Real part of the shunt admittance in mhos at end one.

(F4) - Imaginary part of the shunt admittance in mhos at end one.

(F5) - Real part of the shunt admittance in mhos at end two

(F6) - Imaginary part of the shunt admittance in mhos at end two.

Notes:

* The rules for transmission-line cards are the same as for network cards. All transmission line cards for a particular transmission line configuration must occur together with no other cards (except NT cards) separating them. When the first TL or NT card is read following a card other than a TL or NT card, all previous network or transmission line data are destroyed. Hence, if a set of TL cards is to be modified, all transmission-line and network data must be input again in the modified form. Dimensions in the program limit the number of cards in a group that may be specified. In the NEC demonstration deck, the number of two-port networks (specified by NT cards and TL cards) is limited to

thirty, and the number of different segments having network ports connected to them is limited to thirty.

- * One or more networks (including transmission lines) may be connected to any given segment. Multiple network ports connected to one segment are connected in parallel.
- * If a transmission line is connected to a segment that has been impedance loaded (*i.e.*, through the use of an LD card), the load acts in series with the line.
- * Use of a transmission-line (TL) card after any form of execute requires recalculation of the current only, and does not require recalculation of the matrix.
- * NT and TL cards do not affect symmetry.

Write NGF File (WG)

Purpose: To write a NGF file for a structure on the file TAPE20.

Card:

Cols	Parameter
1- 2	WG
3-80	blank

Parameters:

None

Notes:

* See Section III-5.

Execute (XQ)

Purpose: To cause program execution at points in the data stream where execution is not automatic. Options on the card also allow for automatic generation of radiation patterns in either of two vertical cuts.

Card:

Cols	Parameter
1- 2	XQ
3- 5	I1
6-80	Blank

Parameters:

Integer

(I1) Options controlled by (I1) are:

- 0 - no patterns requested (normal case).
- 1 - generates a pattern cut in the XZ plane, *i.e.*, $\phi = 0$ degrees and θ varies from 0 degrees to 90 degrees in 1 deg. steps.
- 2 - generates a pattern cut in the YZ plane, *i.e.*, $\phi = 90$ degrees θ varies from 0 degrees to 90 degrees in 1 degree steps.
- 3 - generates both of the cuts described for the values 1 and 2.

The remainder of the card is blank.

Notes:

- * For the case of a single frequency step, four cards will automatically produce program execution (*i.e.*, the program stops reading data and proceeds with the calculations requested to that point); the four cards are the execute card (XQ), the near-field cards (NE, NH), and the radiation-pattern card (RP). Thus, the only time the XQ card is mandatory, for the case of one frequency, is when only currents and impedances for the structure are desired. On the other hand, for the case of automatic frequency stepping, only the XQ card and the RP card cause execution. Thus, if only near-fields or currents are desired, the XQ card is mandatory to cause execution. Furthermore, the XQ card can always be used as a divider in the data after a card which produces an execute. For instance, if the user wished to put a blank XQ card after an RP card to more easily divide the data into execution groups, the XQ card will act as a do-nothing card.
- * The radiation-pattern generation option of the XQ card must not be used when a radial wire ground screen or a second medium has been specified. For these cases, the RP card is used where the presence of the additional ground parameters is indicated.

4. SOMNEC Input For Sommerfeld/Norton Ground Method

When the Sommerfeld/Norton ground option is requested on the GN card, NEC reads interpolation tables from the file TAPE21. This file must be created prior to the NEC run by running the separate program SOMNEC. SOMNEC reads a single data card with the parameters:

* EPR, SIG, FMHZ, IPT (format 3E10.3, I5)

The three decimal numbers end in columns 10, 20, and 30 and the integer IPT must end in column 35. The parameters are:

* EPR = relative dielectric constant of ground (ϵ_r)
* SIG = conductivity of ground in mhos/m (S)
* FMHZ = frequency in MHz
* IPT = 1 to print the interpolation table
* = 0 for no printed output.

The interpolation tables depend only on the complex dielectric constant

* $E_c = \epsilon_r - j \cdot \text{SIG} / (\omega \cdot \epsilon_0)$,
* $\epsilon_r = \text{EPR}$

If SIG is input as a negative number, the program sets

* $E_c = \text{EPR} - j|\text{SIG}|$,

and frequency is not used. The tables are written on the file TAPE21. The central processor time to generate the tables on a CDC 7600 computer is about 15 seconds.

5. The Numerical Green's Function Option

With the Numerical Green's Function (NGF) option, a fixed structure and its environment may be modeled and the factored interaction matrix saved on a file. New parts may then be added to the model in subsequent computer runs and the complete solution obtained without repeating calculation for the data on the file. The main purpose of the NGF is to avoid the unnecessary repetition of calculations when a part of a model, such as a single antenna in a complex environment, will be modified one or more times while the environment remains fixed. For example, when modeling antennas on ships, several antenna designs or locations may be considered on an otherwise unchanged ship. With the NGF, the self-interaction matrix for the fixed environment may be computed, factored for solution, and saved on a tape or disk file. Solution for a new antenna then requires only the evaluation of the self-interaction matrix for the antenna, the mutual antenna-to-environment interactions, and matrix manipulations for a partitioned-matrix solution. When the previously written NGF file is used, the free-space Green's function in the NEC formulation is, in effect, replaced by the Green's function for the environment.

Another reason for using the NGF option is to exploit partial symmetry in a structure. In a single run, a structure must be perfectly symmetric for NEC to use symmetry in the solution. Any unsymmetric segments or patches, or ones that lie in a symmetry plane or on the axis of rotation, will destroy the symmetry. Such partial symmetry may be exploited to reduce solution time by running the symmetric part of the model first and writing a NGF file. The unsymmetric parts may then be added in a second run.

Use of the NGF option may also be warranted for large, time-consuming models to save an expensive result for further use. Without adding new antennas, it may be used with a new excitation or to compute new radiation, near-field, or coupling data not computed in the original run.

To write a NGF file for the structure, the data deck is constructed as for a normal run. After the GE card, the frequency, ground parameters, and loading may be set by FR, GN, and LD cards. EK or KH may also be used. Other cards, such as EX or NT that do not change the matrix, will not affect the NGF and will not be saved on the file. After the model has been defined, a WG card is used to fill and factor the matrix and cause the NGF data to be written to the file TAPE20. TAPE20 should be saved after the run terminates. Other cards may follow the WG card to define an excitation and request field calculations as in a normal run. WG should be the first card to request filling and factoring of the matrix, however, since it reserves array space for the matrix in subsequent runs when the NGF is used. Hence, WG should come before XQ, RP, NE, or NH. The FR card must not specify multiple frequencies when a NGF is written.

To use a previously generated NGF file, the file is made available to the program as TAPE20. The first structure-geometry data card, following the CE card, must be a GF card to cause the program to read TAPE20. Subsequent structure data cards define the new structure to be added to the NGF structure. All types of structure geometry data cards may be used, although GM, GR, GX, and GS will affect new structure but not that from the NGF file. GR and GX will have their usual effect on the new structure but will not result in use of symmetry in the solution. Symmetry may be used in writing the NGF file but not for new structures used with the NGF.

For connections between the new structure and NGF structure, the new segment

ends or patch centers are made to coincide with the NGF segment ends or patch centers as in a normal run. The rules still apply that only a single segment may connect to a given patch and a segment may have a patch connection on only one of its ends. Also, a wire may never connect to a patch formed by subdividing another patch for a previous connection.

Following the GE card the program control cards may be used as usual, with the exception that FR and GN cards may not be used. The parameters from these cards are taken from the NGF file and cannot be changed. LD cards may be used to load new segments but not segments in the NGF. If integers I3 and I4 on a LD card are blank, the card will load all new segments (new segments with tag LDTAG if I2 is not zero) but not NGF segments. If I2, I3 and I4 select a specific NGF segment, the run will terminate with an error message. The effect of loading on NGF segments may be obtained with an NT card, since NT (and TL) may connect to either new or NGF segments.

Computation time for a run using a NGF file may be estimated from the formulas in Section V by evaluating the time to run the complete structure and subtracting time to fill and factor the matrix for the NGF part of the structure alone (T1 and T2). If the new structure connects to the NGF structure, new unknowns - in addition to those for the new segments and patches - are produced and should be included in the time estimate for the complete structure. If a new segment or patch connects to a NGF segment, the current expansion function for the NGF segment is modified. One new unknown is then added to the matrix equation to represent the modified expansion function and suppress the old expansion function. If a new segment connects to a NGF patch, 10 new unknowns are produced in addition to that for the new segment. Four new patches are automatically generated at the connection point accounting for eight unknowns. The remaining two new unknowns are needed to suppress the current on the old patch that has been replaced.

Although connection to a NGF segment modifies the old basis function, the current on the segment will be printed in its normal location in the table of segment currents. When a new wire connects to a NGF patch, the patch is divided into four new patches that will appear after the user-defined patches in the patch data. The original patch will be listed in the tables but with nearly zero current. Also, the Z coordinates of the original patch will be set to 9999.

Section IV - NEC OUTPUT

Typical NEC output is illustrated in this section with examples that exercise most of the options available. In addition to demonstrating the use of the code and typical output, the results may be used to check the operation of the code when it is put in use on a new computer system. Most of the output is self-explanatory. The general form is outlined below, the particular points are discussed with the examples in which they occur.

The output follows the form of the input data, starting with the descriptive comments, followed by geometry data and then requested computations. Under the heading "STRUCTURE SPECIFICATION" is a list of the geometry data cards. The heading on the table is for a GW card, giving the X,Y, and Z coordinates of the wire ends, the radius, and the number of segments. Under the heading "WIRE NO." is a count of the number of GW cards. Data from other geometry cards are printed in the table with a label identifying the card. For a patch, the patch number is printed under "WIRE NO." followed by a letter to indicate the shape option - P for arbitrary, R for rectangular, T for triangular, and Q for quadrilateral.

After a GE card is read, a summary of the number of segments and patches is printed. The symmetry flag is zero for no symmetry, positive for planar symmetry, and negative for rotational symmetry. A table of multiple-wire junctions lists all junctions at which three or more wires join. The number of each connection segment is printed preceded by a minus sign if the current reference direction is out of the junction

Data for individual segments are printed under "SEGMENTATION DATA," including angles, alpha and beta, which are defined the same as for the patch normal vector (see **Figure 5**). The connection data shows the connection condition at each segment. "I-" is the number of segment connected to the first end of segment I. If more than one segment connects to this junction, then I- will be the first connected segment following I in the sequence of segments. The numbers under "I+" give the same information for the second end of segment I. If the connection number is positive, the reference directions of the connected segments are parallel. If the number is negative, they are opposed (first end to first end, or second end to second end.) A zero indicates a free wire end, while if it is equal to I, that end of segment I is connected to a ground plane. If it is greater than 10,000, the end is connected to a surface and (I±)-10,000 is the number of the first of the four patches around the connection point.

When patches are used, the next section is "SURFACE PATCH DATA." This includes the coordinates of the patch center, components of the unit normal vector, and patch area. Components of the unit tangent vectors, t1 and t2 (see section II) are also printed for use in reading the surface currents printed later.

The data cards following the geometry cards are printed exactly as they are read by the program. When a card requesting computations is encountered, information on ground parameters and loading is printed, followed by currents. The line "APPROXIMATE INTEGRATION..." gives the separation distance, set by a KH card, at which the Hertzian dipole approximation is used for the electric field due to a segment. If the extended thin-wire kernel has been requested by an EK card, this is also noted at this point in the output. Under "MATRIX TIMING" is printed the time to fill and factor the interaction matrix.

If one or more voltage sources have been specified, the voltage, current, impedance, admittance and input power are printed for each driving point. If the voltage source is the current-slope-discontinuity type, this is noted by "*" after the tag number in the input parameters table (see Example 2). The antenna input parameters are followed by a table giving the current at the center of each segment. This table includes the coordinates at the segment centers and segment lengths in units of wavelength. If the model includes patches, a table of patch currents is printed giving the surface current in components along the tangent vectors t1 and t2 and X, Y, and Z components.

If there are voltage sources on a model, a power budget is printed following the current tables. The input power here is the total power supplied by all voltage sources. The structure loss is ohmic loss in wires, while the network loss is the total power into all network and transmission line ports, assuming no radiation from networks or transmission lines. Finally, the radiated power is computed as input power minus structure and network loss.

Radiated fields or near-fields requested in the input data are printed following the current tables. In the normal radiation-pattern format, transmitting antenna gains are printed in dB in the components requested on the RP card. If an incident-field excitation is used, rather than a voltage source, the gain columns will contain the bistatic scattering cross section (σ/λ^2). For very small gains, the number -999.99 is printed.

The radiation-pattern format also includes the radiated electric field in theta and phi components. These are labeled with the units "volts/m" for $E(R, \theta, \phi)$. Unless the range, R_m , is specified on the RP card, however, the quantity printed is the limit of $E(R, \theta, \phi)$ as R approaches infinity, having units of volts. The polarization is printed in a format for general elliptic polarization, including axial ratio (minor axis/major axis), tilt angle of the major axis (η in **Figure 14**), and sense of rotation (right-hand, left-hand, or linear).

In addition to these basic formats, there are a number of special formats for optional calculations. Many of these occur in the following examples.

Examples 1 through 4

Examples 1 through 4 are simple cases intended to illustrate the basic formats. **Example 1** includes a calculation of near-electric-field along the wire. When the field is computed at the center of a segment without an applied field or loading, the Z-component of electric field is small since the solution procedure enforces the boundary condition at these points. This is a check that the program is operating correctly. The values would be still smaller if the field points were more precisely at the segment centers. The radial, or X, components of the near-field can also be compared with the charge densities at the segment centers ($\rho = 2\pi a \epsilon_0 E_x$). If the fields were computed along the wire axis, the radial field would be set to zero. For a nonplanar structure, however, computation along the axis is the only way to reproduce the conditions of the current solution and obtain small fields at the match points.

In **Example 2** the wire has an even number of segments so that a charge-discontinuity voltage source can be used at the center. The symbol "*" in the table of antenna input parameters is a reminder that this type of source has been used. Three frequencies are run for this case and the EX card option is used to collect and normalize the input impedances. At the end of Example 2 the wire is given the conductivity of aluminum. This has a significant effect since the wire is relatively thin.

Example 3 is a vertical dipole over ground. Since the wire is thick the extended thin-wire approximation has been used. Computation of the average power gain is requested on the RP cards. Over a perfectly conductive ground the average power gain should be 2. The computed result differs by about 1.5%, probably due to the 10-degree steps used in integrating the radiated power. For a more complex structure, the average gain can provide a check on the accuracy of the computed input impedance over a perfect ground where it should equal 2 or in free space where it should equal 1. Example 3 also includes a finitely conducting ground where the average gain of 0.72 indicates that only 36% of the power leaving the antenna is going into the space wave. The formats for normalized gain and the combined space-wave and ground-wave fields are illustrated. At the end of example 3, the wire is excited with an incident wave at 10-degree angles and the PT card option is used to print receiving antenna patterns.

Example 4 includes both patches and wires. Although the structure is over a perfect ground, the average power gain is 1.8. This indicates that the input impedance is inaccurate, probably due to the crude patch model used for the box. Since there is no ohmic loss, a more accurate input resistance can be obtained as:

$$\begin{aligned} \text{Radiated Power} &= (1/2) * (\text{avg. gain}) * (\text{computed input power}) \\ &= 1.016 (10^{-3}) \text{W} \end{aligned}$$

$$\begin{aligned} \text{Radiation resistance} &= 2 * (\text{radiated power}) / |I_{\text{source}}|^2 \\ &= 162.6 \text{ ohms} \end{aligned}$$

Since the input power used in computing the gains in the radiated pattern table is too large by 0.46 dB, the gains can be corrected by adding this factor.

Example 1 (Courier 7-point font and narrow page margins are used in this document to enable "portrait" printing on 8.5 x 11 inch paper, of NEC's ordinarily too-wide, line-printer, output format.)

Input Card Deck:

```
CEEEXAMPLE 1. CENTER FED LINEAR ANTENNA
GW 0,7,0.,0.,-.25,0.,0.,.25,.001
GE
EX 0 0 4 0 1.
XQ
LD 0 0 4 4 10. 3.000E-09 5.300E-11
PQ
NE 0 1 1 15 .001 0 0 0. 0. .01786
EN
```

Line-Printer Output:

1

```
*****
NUMERICAL ELECTROMAGNETICS CODE
*****
```

- - - - COMMENTS - - - -

EXAMPLE 1. CENTER FED LINEAR ANTENNA

- - - STRUCTURE SPECIFICATION - - -

COORDINATES MUST BE INPUT IN METERS OR BE SCALED TO METERS BEFORE STRUCTURE INPUT IS ENDED

WIRE NO.	X1	Y1	Z1	X2	Y2	Z2	RADIUS	NO. OF SEG.	FIRST SEG.	LAST SEG.	TAG NO.
1	.00000	.00000	-.25000	.00000	.00000	.25000	.00100	7	1	7	0

TOTAL SEGMENTS USED= 7 NO. SEG. IN A SYMMETRIC CELL= 7 SYMMETRY FLAG= 0

- MULTIPLE WIRE JUNCTIONS -
 JUNCTION SEGMENTS (- FOR END 1, + FOR END 2)
 NONE

- - - - SEGMENTATION DATA - - - -

COORDINATES IN METERS

I+ AND I- INDICATE THE SEGMENTS BEFORE AND AFTER I

SEG. NO.	COORDINATES OF SEG. CENTER			SEG. LENGTH	ORIENTATION ANGLES		WIRE RADIUS	CONNECTION DATA			TAG NO.
	X	Y	Z		ALPHA	BETA		I-	I	I+	
1	.00000	.00000	-.21429	.07143	90.00000	.00000	.00100	0	1	2	0
2	.00000	.00000	-.14286	.07143	90.00000	.00000	.00100	1	2	3	0
3	.00000	.00000	-.07143	.07143	90.00000	.00000	.00100	2	3	4	0
4	.00000	.00000	.00000	.07143	90.00000	.00000	.00100	3	4	5	0
5	.00000	.00000	.07143	.07143	90.00000	.00000	.00100	4	5	6	0
6	.00000	.00000	.14286	.07143	90.00000	.00000	.00100	5	6	7	0
7	.00000	.00000	.21429	.07143	90.00000	.00000	.00100	6	7	0	0

***** DATA CARD NO. 1 EX 0 0 4 0 1.00000E+00 0.00000E+00 0.00000E+00 0.00000E+00 0.00000E+00 0.00000E+00
 ***** DATA CARD NO. 2 XQ 0 0 0 0 0.00000E+00 0.00000E+00 0.00000E+00 0.00000E+00 0.00000E+00 0.00000E+00

- - - - - FREQUENCY - - - - -

FREQUENCY= 2.9980E+02 MHZ
 WAVELENGTH= 1.0000E+00 METERS

APPROXIMATE INTEGRATION EMPLOYED FOR SEGMENTS MORE THAN 1.000 WAVELENGTHS APART

- - - STRUCTURE IMPEDANCE LOADING - - -

THIS STRUCTURE IS NOT LOADED

- - - ANTENNA ENVIRONMENT - - -

FREE SPACE

- - - MATRIX TIMING - - -

FILL= .067 SEC., FACTOR= .000 SEC.

- - - ANTENNA INPUT PARAMETERS - - -

TAG NO.	SEG. NO.	VOLTAGE (VOLTS)		CURRENT (AMPS)		IMPEDANCE (OHMS)		ADMITTANCE (MHOS)		POWER (WATTS)
		REAL	IMAG.	REAL	IMAG.	REAL	IMAG.	REAL	IMAG.	
0	4	1.00000E+00	0.00000E+00	9.20585E-03	-5.15474E-03	8.26979E+01	4.63060E+01	9.20585E-03	-5.15474E-03	4.60292E-03

- - - CURRENTS AND LOCATION - - -

DISTANCES IN WAVELENGTHS

SEG. NO.	TAG NO.	COORD. OF SEG. CENTER			SEG. LENGTH	CURRENT (AMPS)			PHASE
		X	Y	Z		REAL	IMAG.	MAG.	
1	0	.0000	.0000	-.2143	.07143	2.3592E-03	-1.6881E-03	2.9010E-03	-35.584
2	0	.0000	.0000	-.1429	.07143	5.9998E-03	-4.0463E-03	7.2367E-03	-33.996
3	0	.0000	.0000	-.0714	.07143	8.3711E-03	-5.1857E-03	9.8472E-03	-31.777
4	0	.0000	.0000	.0000	.07143	9.2058E-03	-5.1547E-03	1.0551E-02	-29.246
5	0	.0000	.0000	.0714	.07143	8.3711E-03	-5.1857E-03	9.8472E-03	-31.777
6	0	.0000	.0000	.1429	.07143	5.9998E-03	-4.0463E-03	7.2367E-03	-33.996
7	0	.0000	.0000	.2143	.07143	2.3592E-03	-1.6881E-03	2.9010E-03	-35.584

- - - POWER BUDGET - - -

INPUT POWER = 4.6029E-03 WATTS
 RADIATED POWER= 4.6029E-03 WATTS
 STRUCTURE LOSS= 0.0000E+00 WATTS
 NETWORK LOSS = 0.0000E+00 WATTS
 EFFICIENCY = 100.00 PERCENT

***** DATA CARD NO. 3 LD 0 0 4 4 1.00000E+01 3.00000E-09 5.30000E-11 0.00000E+00 0.00000E+00 0.00000E+00
 ***** DATA CARD NO. 4 PQ 0 0 0 0 0.00000E+00 0.00000E+00 0.00000E+00 0.00000E+00 0.00000E+00 0.00000E+00
 ***** DATA CARD NO. 5 NE 0 1 1 15 1.00000E-03 0.00000E+00 0.00000E+00 0.00000E+00 0.00000E+00 1.78600E-02

- - - STRUCTURE IMPEDANCE LOADING - - -

LOCATION		RESISTANCE	INDUCTANCE	CAPACITANCE	IMPEDANCE (OHMS)		CONDUCTIVITY	TYPE
ITAG	FROM THRU	OHMS	HENRYS	FARADS	REAL	IMAGINARY	MHOS/METER	
4	4	.1000E+02	.3000E-08	.5300E-10				SERIES

--- ANTENNA ENVIRONMENT ---
FREE SPACE

--- MATRIX TIMING ---
FILL= .067 SEC., FACTOR= .000 SEC.

--- ANTENNA INPUT PARAMETERS ---

TAG NO.	SEG. NO.	VOLTAGE (VOLTS)		CURRENT (AMPS)		IMPEDANCE (OHMS)		ADMITTANCE (MHOS)		POWER (WATTS)
		REAL	IMAG.	REAL	IMAG.	REAL	IMAG.	REAL	IMAG.	
0	4	1.00000E+00	0.00000E+00	8.95465E-03	-4.05149E-03	9.26979E+01	4.19407E+01	8.95465E-03	-4.05149E-03	4.47733E-03

--- CURRENTS AND LOCATION ---
DISTANCES IN WAVELENGTHS

SEG. NO.	TAG NO.	COORD. OF SEG. CENTER			SEG. LENGTH	CURRENT (AMPS)			PHASE
		X	Y	Z		REAL	IMAG.	MAG.	
1	0	.0000	.0000	-.2143	.07143	2.3241E-03	-1.3790E-03	2.7024E-03	-30.682
2	0	.0000	.0000	-.1429	.07143	5.8908E-03	-3.2779E-03	6.7413E-03	-29.093
3	0	.0000	.0000	-.0714	.07143	8.1824E-03	-4.1467E-03	9.1731E-03	-26.875
4	0	.0000	.0000	.0000	.07143	8.9547E-03	-4.0515E-03	9.8285E-03	-24.344
5	0	.0000	.0000	.0714	.07143	8.1824E-03	-4.1467E-03	9.1731E-03	-26.875
6	0	.0000	.0000	.1429	.07143	5.8908E-03	-3.2779E-03	6.7413E-03	-29.093
7	0	.0000	.0000	.2143	.07143	2.3241E-03	-1.3790E-03	2.7024E-03	-30.682

--- CHARGE DENSITIES ---
DISTANCES IN WAVELENGTHS

SEG. NO.	TAG NO.	COORD. OF SEG. CENTER			SEG. LENGTH	CHARGE DENSITY (COULOMBS/METER)			PHASE
		X	Y	Z		REAL	IMAG.	MAG.	
1	0	.0000	.0000	-.2143	.07143	1.8292E-11	3.1761E-11	3.6652E-11	60.061
2	0	.0000	.0000	-.1429	.07143	1.0429E-11	2.2040E-11	2.4383E-11	64.676
3	0	.0000	.0000	-.0714	.07143	2.1140E-12	1.1638E-11	1.1829E-11	79.705
4	0	.0000	.0000	.0000	.07143	5.1684E-19	2.3814E-19	5.6906E-19	24.738
5	0	.0000	.0000	.0714	.07143	-2.1140E-12	-1.1638E-11	1.1829E-11	-100.295
6	0	.0000	.0000	.1429	.07143	-1.0429E-11	-2.2040E-11	2.4383E-11	-115.324
7	0	.0000	.0000	.2143	.07143	-1.8292E-11	-3.1761E-11	3.6652E-11	-119.939

--- POWER BUDGET ---

INPUT POWER = 4.4773E-03 WATTS
RADIATED POWER= 3.9943E-03 WATTS
STRUCTURE LOSS= 4.8300E-04 WATTS
NETWORK LOSS = 0.0000E+00 WATTS
EFFICIENCY = 89.21 PERCENT

--- NEAR ELECTRIC FIELDS ---

LOCATION			EX		EY		EZ	
X METERS	Y METERS	Z METERS	MAGNITUDE VOLTS/M	PHASE DEGREES	MAGNITUDE VOLTS/M	PHASE DEGREES	MAGNITUDE VOLTS/M	PHASE DEGREES
.0010	.0000	.0000	1.0228E-05	24.74	0.0000E+00	.00	1.3042E+01	-175.10
.0010	.0000	.0179	5.5442E+01	-66.31	0.0000E+00	.00	1.2537E+01	-175.08
.0010	.0000	.0357	1.0968E+02	-67.15	0.0000E+00	.00	6.7271E+00	-175.46
.0010	.0000	.0536	1.5608E+02	-88.85	0.0000E+00	.00	8.4339E-01	-179.75
.0010	.0000	.0714	2.1267E+02	-100.30	0.0000E+00	.00	4.2135E-04	-6.13
.0010	.0000	.0893	2.7147E+02	-106.86	0.0000E+00	.00	3.4497E-01	-8.87
.0010	.0000	.1072	3.2920E+02	-111.08	0.0000E+00	.00	2.8000E-01	22.83

.0010	.0000	.1250	3.8592E+02	-113.51	0.0000E+00	.00	2.2076E-01	74.41
.0010	.0000	.1429	4.3835E+02	-115.33	0.0000E+00	.00	3.0905E-04	-94.14
.0010	.0000	.1607	4.8563E+02	-116.77	0.0000E+00	.00	2.1937E-01	-106.41
.0010	.0000	.1786	5.2800E+02	-117.97	0.0000E+00	.00	1.9750E+00	57.57
.0010	.0000	.1965	5.9664E+02	-119.06	0.0000E+00	.00	3.3113E+00	58.63
.0010	.0000	.2143	6.5880E+02	-119.94	0.0000E+00	.00	9.9556E-03	-121.24
.0010	.0000	.2322	7.1246E+02	-120.67	0.0000E+00	.00	1.0680E+01	-121.66
.0010	.0000	.2500	5.5195E+02	-121.29	0.0000E+00	.00	3.8032E+02	-121.43

***** DATA CARD NO. 6 EN 0 0 0 0 0.00000E+00 0.00000E+00 0.00000E+00 0.00000E+00 0.00000E+00 0.00000E+00

RUN TIME = .650

Example 2

Input card deck:

```

CMEXAMPLE 2.  CENTER FED LINEAR ANTENNA.
CM          CURRENT SLOPE DISCONTINUITY SOURCE.
CM          1. THIN PERFECTLY CONDUCTING WIRE
CE          2. THIN ALUMINUM WIRE
GW 0      8  0.          0.          -.25      0.          0.          .25      .00001
GE
FR 0      3  0      0      200.      50.
EX 5      0  5      1      1.          0.          50.
XQ
LD 5      0  0      0      3.720E+07
FR 0      1  0      0      300.
EX 5      0  5      0      1.
XQ
EN
    
```

Output printout:

1

```

*****
NUMERICAL ELECTROMAGNETICS CODE
*****
    
```

- - - - COMMENTS - - - -

```

EXAMPLE 2.  CENTER FED LINEAR ANTENNA.
CURRENT SLOPE DISCONTINUITY SOURCE.
1. THIN PERFECTLY CONDUCTING WIRE
2. THIN ALUMINUM WIRE
    
```

- - - STRUCTURE SPECIFICATION - - -

COORDINATES MUST BE INPUT IN METERS OR BE SCALED TO METERS BEFORE STRUCTURE INPUT IS ENDED

WIRE NO.	X1	Y1	Z1	X2	Y2	Z2	RADIUS	NO. OF SEG.	FIRST SEG.	LAST SEG.	TAG NO.
1	.00000	.00000	-.25000	.00000	.00000	.25000	.00001	8	1	8	0

TOTAL SEGMENTS USED= 8 NO. SEG. IN A SYMMETRIC CELL= 8 SYMMETRY FLAG= 0

- MULTIPLE WIRE JUNCTIONS -

JUNCTION SEGMENTS (- FOR END 1, + FOR END 2)
NONE

- - - - SEGMENTATION DATA - - - -

COORDINATES IN METERS

I+ AND I- INDICATE THE SEGMENTS BEFORE AND AFTER I

SEG. NO.	COORDINATES OF SEG. CENTER			SEG. LENGTH	ORIENTATION ANGLES		WIRE RADIUS	CONNECTION DATA			TAG NO.
	X	Y	Z		ALPHA	BETA		I-	I	I+	
1	.00000	.00000	-.21875	.06250	90.00000	.00000	.00001	0	1	2	0
2	.00000	.00000	-.15625	.06250	90.00000	.00000	.00001	1	2	3	0

3	.00000	.00000	-.09375	.06250	90.00000	.00000	.00001	2	3	4	0
4	.00000	.00000	-.03125	.06250	90.00000	.00000	.00001	3	4	5	0
5	.00000	.00000	.03125	.06250	90.00000	.00000	.00001	4	5	6	0
6	.00000	.00000	.09375	.06250	90.00000	.00000	.00001	5	6	7	0
7	.00000	.00000	.15625	.06250	90.00000	.00000	.00001	6	7	8	0
8	.00000	.00000	.21875	.06250	90.00000	.00000	.00001	7	8	0	0

```

***** DATA CARD NO. 1 FR 0 3 0 0 2.00000E+02 5.00000E+01 0.00000E+00 0.00000E+00 0.00000E+00 0.00000E+00
***** DATA CARD NO. 2 EX 5 0 5 1 1.00000E+00 0.00000E+00 5.00000E+01 0.00000E+00 0.00000E+00 0.00000E+00
***** DATA CARD NO. 3 XQ 0 0 0 0 0.00000E+00 0.00000E+00 0.00000E+00 0.00000E+00 0.00000E+00 0.00000E+00
    
```

----- FREQUENCY -----

FREQUENCY= 2.0000E+02 MHZ
 WAVELENGTH= 1.4990E+00 METERS

APPROXIMATE INTEGRATION EMPLOYED FOR SEGMENTS MORE THAN 1.000 WAVELENGTHS APART

----- STRUCTURE IMPEDANCE LOADING -----

THIS STRUCTURE IS NOT LOADED

----- ANTENNA ENVIRONMENT -----

FREE SPACE

----- MATRIX TIMING -----

FILL= .100 SEC., FACTOR= .000 SEC.

----- ANTENNA INPUT PARAMETERS -----

TAG NO.	SEG. NO.	VOLTAGE (VOLTS)		CURRENT (AMPS)		IMPEDANCE (OHMS)		ADMITTANCE (MHOS)		POWER (WATTS)
		REAL	IMAG.	REAL	IMAG.	REAL	IMAG.	REAL	IMAG.	
0 *	5	1.00000E+00	0.00000E+00	6.64061E-05	1.57934E-03	2.65762E+01	-6.32060E+02	6.64061E-05	1.57934E-03	3.32031E-05

----- CURRENTS AND LOCATION -----

DISTANCES IN WAVELENGTHS

SEG. NO.	TAG NO.	COORD. OF SEG. CENTER			SEG. LENGTH	CURRENT (AMPS)			PHASE
		X	Y	Z		REAL	IMAG.	MAG.	
1	0	.0000	.0000	-.1459	.04169	1.5369E-05	2.5220E-04	2.5267E-04	86.513
2	0	.0000	.0000	-.1042	.04169	3.9856E-05	7.0589E-04	7.0702E-04	86.768
3	0	.0000	.0000	-.0625	.04169	5.6673E-05	1.1008E-03	1.1023E-03	87.053
4	0	.0000	.0000	-.0208	.04169	6.5314E-05	1.4319E-03	1.4334E-03	87.388
5	0	.0000	.0000	.0208	.04169	6.5314E-05	1.4319E-03	1.4334E-03	87.388
6	0	.0000	.0000	.0625	.04169	5.6673E-05	1.1008E-03	1.1023E-03	87.053
7	0	.0000	.0000	.1042	.04169	3.9856E-05	7.0589E-04	7.0702E-04	86.768
8	0	.0000	.0000	.1459	.04169	1.5369E-05	2.5220E-04	2.5267E-04	86.513

----- POWER BUDGET -----

INPUT POWER = 3.3203E-05 WATTS
 RADIATED POWER= 3.3203E-05 WATTS
 STRUCTURE LOSS= 0.0000E+00 WATTS
 NETWORK LOSS = 0.0000E+00 WATTS
 EFFICIENCY = 100.00 PERCENT

- - - - - FREQUENCY - - - - -

FREQUENCY= 2.5000E+02 MHZ
 WAVELENGTH= 1.1992E+00 METERS

APPROXIMATE INTEGRATION EMPLOYED FOR SEGMENTS MORE THAN 1.000 WAVELENGTHS APART

- - - STRUCTURE IMPEDANCE LOADING - - -

THIS STRUCTURE IS NOT LOADED

- - - ANTENNA ENVIRONMENT - - -

FREE SPACE

- - - MATRIX TIMING - - -

FILL= .100 SEC., FACTOR= .000 SEC.

- - - ANTENNA INPUT PARAMETERS - - -

TAG NO.	SEG. NO.	VOLTAGE (VOLTS)		CURRENT (AMPS)		IMPEDANCE (OHMS)		ADMITTANCE (MHOS)		POWER (WATTS)
		REAL	IMAG.	REAL	IMAG.	REAL	IMAG.	REAL	IMAG.	
0 *	5	1.0000E+00	0.0000E+00	6.16984E-04	3.56466E-03	4.71431E+01	-2.72372E+02	6.16984E-04	3.56466E-03	3.08492E-04

- - - CURRENTS AND LOCATION - - -

DISTANCES IN WAVELENGTHS

SEG. NO.	TAG NO.	COORD. OF SEG. CENTER			SEG. LENGTH	CURRENT (AMPS)			PHASE
		X	Y	Z		REAL	IMAG.	MAG.	
1	0	.0000	.0000	-.1824	.05212	1.3629E-04	6.4701E-04	6.6120E-04	78.105
2	0	.0000	.0000	-.1303	.05212	3.6169E-04	1.7863E-03	1.8225E-03	78.553
3	0	.0000	.0000	-.0782	.05212	5.2215E-04	2.7057E-03	2.7557E-03	79.077
4	0	.0000	.0000	-.0261	.05212	6.0627E-04	3.3503E-03	3.4047E-03	79.743
5	0	.0000	.0000	.0261	.05212	6.0627E-04	3.3503E-03	3.4047E-03	79.743
6	0	.0000	.0000	.0782	.05212	5.2215E-04	2.7057E-03	2.7557E-03	79.077
7	0	.0000	.0000	.1303	.05212	3.6169E-04	1.7863E-03	1.8225E-03	78.553
8	0	.0000	.0000	.1824	.05212	1.3629E-04	6.4701E-04	6.6120E-04	78.105

- - - POWER BUDGET - - -

INPUT POWER = 3.0849E-04 WATTS
 RADIATED POWER= 3.0849E-04 WATTS
 STRUCTURE LOSS= 0.0000E+00 WATTS
 NETWORK LOSS = 0.0000E+00 WATTS
 EFFICIENCY = 100.00 PERCENT

- - - - - FREQUENCY - - - - -

FREQUENCY= 3.0000E+02 MHZ
 WAVELENGTH= 9.9933E-01 METERS

APPROXIMATE INTEGRATION EMPLOYED FOR SEGMENTS MORE THAN 1.000 WAVELENGTHS APART

- - - STRUCTURE IMPEDANCE LOADING - - -

THIS STRUCTURE IS NOT LOADED

- - - ANTENNA ENVIRONMENT - - -

FREE SPACE

- - - MATRIX TIMING - - -

FILL= .100 SEC., FACTOR= .000 SEC.

- - - ANTENNA INPUT PARAMETERS - - -

TAG NO.	SEG. NO.	VOLTAGE (VOLTS)		CURRENT (AMPS)		IMPEDANCE (OHMS)		ADMITTANCE (MHOS)		POWER (WATTS)
		REAL	IMAG.	REAL	IMAG.	REAL	IMAG.	REAL	IMAG.	
0 *	5	1.0000E+00	0.0000E+00	9.39012E-03	-5.32909E-03	8.05511E+01	4.57144E+01	9.39012E-03	-5.32909E-03	4.69506E-03

- - - CURRENTS AND LOCATION - - -

DISTANCES IN WAVELENGTHS

SEG. NO.	TAG NO.	COORD. OF SEG. CENTER			SEG. LENGTH	CURRENT (AMPS)			PHASE
		X	Y	Z		REAL	IMAG.	MAG.	
1	0	.0000	.0000	-.2189	.06254	1.9607E-03	-1.2799E-03	2.3415E-03	-33.135
2	0	.0000	.0000	-.1564	.06254	5.3517E-03	-3.4033E-03	6.3422E-03	-32.454
3	0	.0000	.0000	-.0938	.06254	7.8678E-03	-4.8421E-03	9.2384E-03	-31.610
4	0	.0000	.0000	-.0313	.06254	9.2168E-03	-5.4147E-03	1.0690E-02	-30.433
5	0	.0000	.0000	.0313	.06254	9.2168E-03	-5.4147E-03	1.0690E-02	-30.433
6	0	.0000	.0000	.0938	.06254	7.8678E-03	-4.8421E-03	9.2384E-03	-31.610
7	0	.0000	.0000	.1564	.06254	5.3517E-03	-3.4033E-03	6.3422E-03	-32.454
8	0	.0000	.0000	.2189	.06254	1.9607E-03	-1.2799E-03	2.3415E-03	-33.135

- - - POWER BUDGET - - -

INPUT POWER = 4.6951E-03 WATTS
 RADIATED POWER= 4.6951E-03 WATTS
 STRUCTURE LOSS= 0.0000E+00 WATTS
 NETWORK LOSS = 0.0000E+00 WATTS
 EFFICIENCY = 100.00 PERCENT

- - - INPUT IMPEDANCE DATA - - -

SOURCE SEGMENT NO. 5
 NORMALIZATION FACTOR= 5.00000E+01

FREQ. MHZ	UNNORMALIZED IMPEDANCE		NORMALIZED IMPEDANCE	
	RESISTANCE OHMS	REACTANCE OHMS	RESISTANCE OHMS	REACTANCE OHMS
200.000	2.65762E+01	-6.32060E+02	5.31523E-01	-1.26412E+01
250.000	4.71431E+01	-2.72372E+02	9.42862E-01	-5.44744E+00
300.000	8.05511E+01	4.57144E+01	1.61102E+00	9.14289E-01

***** DATA CARD NO. 4 LD 5 0 0 0 3.72000E+07 0.00000E+00 0.00000E+00 0.00000E+00 0.00000E+00 0.00000E+00
 ***** DATA CARD NO. 5 FR 0 1 0 0 3.00000E+02 0.00000E+00 0.00000E+00 0.00000E+00 0.00000E+00 0.00000E+00
 ***** DATA CARD NO. 6 EX 5 0 5 0 1.00000E+00 0.00000E+00 0.00000E+00 0.00000E+00 0.00000E+00 0.00000E+00
 ***** DATA CARD NO. 7 XQ 0 0 0 0 0.00000E+00 0.00000E+00 0.00000E+00 0.00000E+00 0.00000E+00 0.00000E+00

- - - - - FREQUENCY - - - - -

FREQUENCY= 3.0000E+02 MHZ
 WAVELENGTH= 9.9933E-01 METERS

APPROXIMATE INTEGRATION EMPLOYED FOR SEGMENTS MORE THAN 1.000 WAVELENGTHS APART

- - - STRUCTURE IMPEDANCE LOADING - - -

LOCATION	RESISTANCE	INDUCTANCE	CAPACITANCE	IMPEDANCE (OHMS)	CONDUCTIVITY	TYPE
ITAG FROM THRU	OHMS	HENRYS	FARADS	REAL IMAGINARY	MHOS/METER	
ALL					.3720E+08	WIRE

- - - ANTENNA ENVIRONMENT - - -

FREE SPACE

- - - MATRIX TIMING - - -

FILL= .100 SEC., FACTOR= .000 SEC.

- - - ANTENNA INPUT PARAMETERS - - -

TAG NO.	SEG. NO.	VOLTAGE (VOLTS)		CURRENT (AMPS)		IMPEDANCE (OHMS)		ADMITTANCE (MHOS)		POWER (WATTS)
		REAL	IMAG.	REAL	IMAG.	REAL	IMAG.	REAL	IMAG.	
0 *	5	1.00000E+00	0.00000E+00	6.64431E-03	-3.86660E-03	1.12430E+02	6.54276E+01	6.64431E-03	-3.86660E-03	3.32215E-03

- - - CURRENTS AND LOCATION - - -

DISTANCES IN WAVELENGTHS

SEG. NO.	TAG NO.	COORD. OF SEG. CENTER			SEG. LENGTH	CURRENT (AMPS)			PHASE
		X	Y	Z		REAL	IMAG.	MAG.	
1	0	.0000	.0000	-.2189	.06254	1.3862E-03	-9.6305E-04	1.6879E-03	-34.790
2	0	.0000	.0000	-.1564	.06254	3.7848E-03	-2.5546E-03	4.5663E-03	-34.018
3	0	.0000	.0000	-.0938	.06254	5.5658E-03	-3.6091E-03	6.6336E-03	-32.961
4	0	.0000	.0000	-.0313	.06254	6.5215E-03	-3.9782E-03	7.6392E-03	-31.384
5	0	.0000	.0000	.0313	.06254	6.5215E-03	-3.9782E-03	7.6392E-03	-31.384
6	0	.0000	.0000	.0938	.06254	5.5658E-03	-3.6091E-03	6.6336E-03	-32.961
7	0	.0000	.0000	.1564	.06254	3.7848E-03	-2.5546E-03	4.5663E-03	-34.018
8	0	.0000	.0000	.2189	.06254	1.3862E-03	-9.6305E-04	1.6879E-03	-34.790

- - - POWER BUDGET - - -

INPUT POWER = 3.3222E-03 WATTS
 RADIATED POWER= 2.4402E-03 WATTS
 STRUCTURE LOSS= 8.8199E-04 WATTS
 NETWORK LOSS = 0.0000E+00 WATTS
 EFFICIENCY = 73.45 PERCENT

***** DATA CARD NO. 8 EN 0 0 0 0 0.00000E+00 0.00000E+00 0.00000E+00 0.00000E+00 0.00000E+00 0.00000E+00

RUN TIME = .850

Example 3

Input card deck:

```

CMEXAMPLE 3.  VERTICAL HALF WAVELENGTH ANTENNA OVER GROUND
CM          EXTENDED THIN WIRE KERNEL USED
CM          1. PERFECT GROUND
CM          2. IMPERFECT GROUND INCLUDING GROUND WAVE AND RECEIVING
CE          PATTERN CALCULATIONS
GW 0    9    0.    0.    2.    0.    0.    7.
.3
GE 1
EK
FR 0    1    0    0    30.
EX 0    0    5    0    1.
GN 1
RP 0    10   2 1301  0.    0.    10.    90.
GN 0    0    0    0    6.    1.000E-03
RP 0    10   2 1301  0.    0.    10.    90.
RP 1    10   1    0    1.    0.    2.    0.    1.000E+05
EX 1    10   1    0    0.    0.    0.    10.
PT 2    0    5    5
XQ
EN
    
```

Output printout:

1

```

*****
NUMERICAL ELECTROMAGNETICS CODE
*****
    
```

- - - COMMENTS - - -

```

EXAMPLE 3.  VERTICAL HALF WAVELENGTH ANTENNA OVER GROUND
EXTENDED THIN WIRE KERNEL USED
1. PERFECT GROUND
2. IMPERFECT GROUND INCLUDING GROUND WAVE AND RECEIVING
PATTERN CALCULATIONS
    
```

- - - STRUCTURE SPECIFICATION - - -

```

COORDINATES MUST BE INPUT IN
METERS OR BE SCALED TO METERS
BEFORE STRUCTURE INPUT IS ENDED
    
```

WIRE NO.	X1	Y1	Z1	X2	Y2	Z2	RADIUS	NO. OF SEG.	FIRST SEG.	LAST SEG.	TAG NO.
1	.00000	.00000	2.00000	.00000	.00000	7.00000	.30000	9	1	9	0

GROUND PLANE SPECIFIED.

WHERE WIRE ENDS TOUCH GROUND, CURRENT WILL BE INTERPOLATED TO IMAGE IN GROUND PLANE.

TOTAL SEGMENTS USED= 9 NO. SEG. IN A SYMMETRIC CELL= 9 SYMMETRY FLAG= 0

- MULTIPLE WIRE JUNCTIONS -
 JUNCTION SEGMENTS (- FOR END 1, + FOR END 2)
 NONE

- - - - SEGMENTATION DATA - - - -

COORDINATES IN METERS

I+ AND I- INDICATE THE SEGMENTS BEFORE AND AFTER I

SEG. NO.	COORDINATES OF SEG. CENTER			SEG. LENGTH	ORIENTATION ANGLES		WIRE RADIUS	CONNECTION DATA			TAG NO.
	X	Y	Z		ALPHA	BETA		I-	I	I+	
1	.00000	.00000	2.27778	.55556	90.00000	.00000	.30000	0	1	2	0
2	.00000	.00000	2.83333	.55556	90.00000	.00000	.30000	1	2	3	0
3	.00000	.00000	3.38889	.55556	90.00000	.00000	.30000	2	3	4	0
4	.00000	.00000	3.94444	.55556	90.00000	.00000	.30000	3	4	5	0
5	.00000	.00000	4.50000	.55556	90.00000	.00000	.30000	4	5	6	0
6	.00000	.00000	5.05556	.55556	90.00000	.00000	.30000	5	6	7	0
7	.00000	.00000	5.61111	.55556	90.00000	.00000	.30000	6	7	8	0
8	.00000	.00000	6.16667	.55556	90.00000	.00000	.30000	7	8	9	0
9	.00000	.00000	6.72222	.55556	90.00000	.00000	.30000	8	9	0	0

***** DATA CARD NO. 1 EK 0 0 0 0 0.00000E-01 0.00000E-01 0.00000E-01 0.00000E-01 0.00000E-01 0.00000E-01
 ***** DATA CARD NO. 2 FR 0 1 0 0 3.00000E+01 0.00000E-01 0.00000E-01 0.00000E-01 0.00000E-01 0.00000E-01
 ***** DATA CARD NO. 3 EX 0 0 5 0 1.00000E+00 0.00000E-01 0.00000E-01 0.00000E-01 0.00000E-01 0.00000E-01
 ***** DATA CARD NO. 4 GN 1 0 0 0 0.00000E-01 0.00000E-01 0.00000E-01 0.00000E-01 0.00000E-01 0.00000E-01
 ***** DATA CARD NO. 5 RP 0 10 2 1301 0.00000E-01 0.00000E-01 1.00000E+01 9.00000E+01 0.00000E-01 0.00000E-01

- - - - - FREQUENCY - - - - -

FREQUENCY= 3.0000E+01 MHZ
 WAVELENGTH= 9.9933E+00 METERS

APPROXIMATE INTEGRATION EMPLOYED FOR SEGMENTS MORE THAN 1.000 WAVELENGTHS APART
 THE EXTENDED THIN WIRE KERNEL WILL BE USED

- - - STRUCTURE IMPEDANCE LOADING - - -

THIS STRUCTURE IS NOT LOADED

- - - ANTENNA ENVIRONMENT - - -

PERFECT GROUND

- - - MATRIX TIMING - - -

FILL= .000 SEC., FACTOR= .000 SEC.

- - - ANTENNA INPUT PARAMETERS - - -

TAG NO.	SEG. NO.	VOLTAGE (VOLTS)		CURRENT (AMPS)		IMPEDANCE (OHMS)		ADMITTANCE (MHOS)		POWER (WATTS)
		REAL	IMAG.	REAL	IMAG.	REAL	IMAG.	REAL	IMAG.	
0	5	1.00000E+00	0.00000E-01	9.31458E-03	-8.66883E-04	1.06437E+02	9.90578E+00	9.31458E-03	-8.66883E-04	4.65729E-03

- - - CURRENTS AND LOCATION - - -

DISTANCES IN WAVELENGTHS

SEG. NO.	TAG NO.	COORD. OF SEG. CENTER			SEG. LENGTH	CURRENT (AMPS)				PHASE
		X	Y	Z	REAL	IMAG.	MAG.			
1	0	.0000	.0000	.2279	.05559	2.8965E-03	-2.5964E-03	3.8899E-03	-41.874	
2	0	.0000	.0000	.2835	.05559	5.5161E-03	-4.2028E-03	6.9348E-03	-37.304	
3	0	.0000	.0000	.3391	.05559	7.4817E-03	-4.6586E-03	8.8135E-03	-31.909	
4	0	.0000	.0000	.3947	.05559	8.7867E-03	-3.7800E-03	9.5653E-03	-23.277	
5	0	.0000	.0000	.4503	.05559	9.3146E-03	-8.6688E-04	9.3548E-03	-5.317	
6	0	.0000	.0000	.5059	.05559	9.0039E-03	-3.8010E-03	9.7734E-03	-22.887	
7	0	.0000	.0000	.5615	.05559	7.8625E-03	-4.6896E-03	9.1549E-03	-30.814	
8	0	.0000	.0000	.6171	.05559	5.9562E-03	-4.2265E-03	7.3034E-03	-35.359	
9	0	.0000	.0000	.6727	.05559	3.2218E-03	-2.6004E-03	4.1403E-03	-38.909	

--- POWER BUDGET ---

INPUT POWER = 4.6573E-03 WATTS
 RADIATED POWER= 4.6573E-03 WATTS
 STRUCTURE LOSS= 0.0000E-01 WATTS
 NETWORK LOSS = 0.0000E-01 WATTS
 EFFICIENCY = 100.00 PERCENT

--- RADIATION PATTERNS ---

-- ANGLES --		- POWER GAINS -			- POLARIZATION - - -			- E(THETA) - - -		- E(PHI) - - -	
THETA	PHI	VERT.	HOR.	TOTAL	AXIAL	TILT	SENSE	MAGNITUDE	PHASE	MAGNITUDE	PHASE
DEGREES	DEGREES	DB	DB	DB	RATIO	DEG.		VOLTS/M	DEGREES	VOLTS/M	DEGREES
.00	.00	-999.99	-999.99	-999.99	.00000	.00		0.00000E-01	.00	0.00000E-01	.00
10.00	.00	-9.87	-999.99	-9.87	.00000	.00	LINEAR	1.69640E-01	-114.38	0.00000E-01	.00
20.00	.00	-4.20	-999.99	-4.20	.00000	.00	LINEAR	3.25649E-01	-114.64	0.00000E-01	.00
30.00	.00	-1.70	-999.99	-1.70	.00000	.00	LINEAR	4.34376E-01	-115.01	0.00000E-01	.00
40.00	.00	-1.74	-999.99	-1.74	.00000	.00	LINEAR	4.32393E-01	-115.37	0.00000E-01	.00
50.00	.00	-6.73	-999.99	-6.73	.00000	.00	LINEAR	2.43508E-01	-115.33	0.00000E-01	.00
60.00	.00	-10.04	-999.99	-10.04	.00000	.00	LINEAR	1.66300E-01	61.67	0.00000E-01	.00
70.00	.00	2.67	-999.99	2.67	.00000	.00	LINEAR	7.18951E-01	62.56	0.00000E-01	.00
80.00	.00	7.20	-999.99	7.20	.00000	.00	LINEAR	1.21100E+00	62.51	0.00000E-01	.00
90.00	.00	8.52	-999.99	8.52	.00000	.00	LINEAR	1.40967E+00	62.47	0.00000E-01	.00
.00	90.00	-999.99	-999.99	-999.99	.00000	.00		0.00000E-01	.00	0.00000E-01	.00
10.00	90.00	-9.87	-999.99	-9.87	.00000	.00	LINEAR	1.69640E-01	-114.38	0.00000E-01	.00
20.00	90.00	-4.20	-999.99	-4.20	.00000	.00	LINEAR	3.25649E-01	-114.64	0.00000E-01	.00
30.00	90.00	-1.70	-999.99	-1.70	.00000	.00	LINEAR	4.34376E-01	-115.01	0.00000E-01	.00
40.00	90.00	-1.74	-999.99	-1.74	.00000	.00	LINEAR	4.32393E-01	-115.37	0.00000E-01	.00
50.00	90.00	-6.73	-999.99	-6.73	.00000	.00	LINEAR	2.43508E-01	-115.33	0.00000E-01	.00
60.00	90.00	-10.04	-999.99	-10.04	.00000	.00	LINEAR	1.66300E-01	61.67	0.00000E-01	.00
70.00	90.00	2.67	-999.99	2.67	.00000	.00	LINEAR	7.18951E-01	62.56	0.00000E-01	.00
80.00	90.00	7.20	-999.99	7.20	.00000	.00	LINEAR	1.21100E+00	62.51	0.00000E-01	.00
90.00	90.00	8.52	-999.99	8.52	.00000	.00	LINEAR	1.40967E+00	62.47	0.00000E-01	.00

AVERAGE POWER GAIN= 2.02793E+00 SOLID ANGLE USED IN AVERAGING=(.5000)*PI STERADIANS.

--- NORMALIZED GAIN ---

VERTICAL GAIN
 NORMALIZATION FACTOR = 8.52 DB

-- ANGLES' --			GAIN	-- ANGLES' --			GAIN	-- ANGLES' --			GAIN
THETA	PHI		DB	THETA	PHI		DB	THETA	PHI		DB
DEGREES	DEGREES			DEGREES	DEGREES			DEGREES	DEGREES		
.00	.00		-1008.51	70.00	.00		-5.85	40.00	90.00		-10.26
10.00	.00		-18.39	80.00	.00		-1.32	50.00	90.00		-15.25
20.00	.00		-12.73	90.00	.00		.00	60.00	90.00		-18.56
30.00	.00		-10.23	.00	90.00		-1008.51	70.00	90.00		-5.85
40.00	.00		-10.26	10.00	90.00		-18.39	80.00	90.00		-1.32
50.00	.00		-15.25	20.00	90.00		-12.73	90.00	90.00		.00
60.00	.00		-18.56	30.00	90.00		-10.23				

***** DATA CARD NO. 6 GN 0 0 0 0 6.00000E+00 1.00000E-03 0.00000E-01 0.00000E-01 0.00000E-01 0.00000E-01
 ***** DATA CARD NO. 7 RP 0 10 2 1301 0.00000E-01 0.00000E-01 1.00000E+01 9.00000E+01 0.00000E-01 0.00000E-01

- - - STRUCTURE IMPEDANCE LOADING - - -

THIS STRUCTURE IS NOT LOADED

- - - ANTENNA ENVIRONMENT - - -

FINITE GROUND. REFLECTION COEFFICIENT APPROXIMATION
RELATIVE DIELECTRIC CONST.= 6.000
CONDUCTIVITY= 1.000E-03 MHOS/METER
COMPLEX DIELECTRIC CONSTANT= 6.00000E+00-5.99200E-01

- - - MATRIX TIMING - - -

FILL= .000 SEC., FACTOR= .000 SEC.

- - - ANTENNA INPUT PARAMETERS - - -

Table with 7 columns: TAG NO., SEG. NO., VOLTAGE (VOLTS) REAL, VOLTAGE (VOLTS) IMAG., CURRENT (AMPS) REAL, CURRENT (AMPS) IMAG., IMPEDANCE (OHMS) REAL, IMPEDANCE (OHMS) IMAG., ADMITTANCE (MHOS) REAL, ADMITTANCE (MHOS) IMAG., POWER (WATTS). Row 1: 0, 5, 1.00000E+00, 0.00000E-01, 8.91204E-03, -8.82840E-04, 1.11117E+02, 1.10075E+01, 8.91204E-03, -8.82840E-04, 4.45602E-03

- - - CURRENTS AND LOCATION - - -

DISTANCES IN WAVELENGTHS

Table with 10 columns: SEG. NO., TAG NO., COORD. OF CENTER X, COORD. OF CENTER Y, COORD. OF CENTER Z, SEG. LENGTH, CURRENT (AMPS) REAL, CURRENT (AMPS) IMAG., CURRENT (AMPS) MAG., PHASE. Rows 1-9 showing antenna element data.

- - - POWER BUDGET - - -

INPUT POWER = 4.4560E-03 WATTS
RADIATED POWER= 4.4560E-03 WATTS
STRUCTURE LOSS= 0.0000E-01 WATTS
NETWORK LOSS = 0.0000E-01 WATTS
EFFICIENCY = 100.00 PERCENT

- - - RADIATION PATTERNS - - -

Table with 12 columns: THETA DEGREES, PHI DEGREES, POWER GAINS VERT. DB, HOR. DB, TOTAL DB, POLARIZATION AXIAL RATIO, TILT DEG, SENSE, E(THETA) MAGNITUDE VOLTS/M, E(THETA) PHASE DEGREES, E(PHI) MAGNITUDE VOLTS/M, E(PHI) PHASE DEGREES. Rows 1-20 showing radiation pattern data.

AVERAGE POWER GAIN= 7.20699E-01 SOLID ANGLE USED IN AVERAGING=(.5000)*PI STERADIANS.

- - - - NORMALIZED GAIN - - - -

VERTICAL GAIN
 NORMALIZATION FACTOR = 1.54 DB

- - ANGLES' - -			- - ANGLES' - -			- - ANGLES' - -		
THETA	PHI	GAIN	THETA	PHI	GAIN	THETA	PHI	GAIN
DEGREES	DEGREES	DB	DEGREES	DEGREES	DB	DEGREES	DEGREES	DB
.00	.00	-1001.53	70.00	.00	.00	40.00	90.00	-4.99
10.00	.00	-14.41	80.00	.00	-.90	50.00	90.00	-4.48
20.00	.00	-8.72	90.00	.00	-129.90	60.00	90.00	-2.33
30.00	.00	-6.01	.00	90.00	-1001.53	70.00	90.00	.00
40.00	.00	-4.99	10.00	90.00	-14.41	80.00	90.00	-.90
50.00	.00	-4.48	20.00	90.00	-8.72	90.00	90.00	-129.90
60.00	.00	-2.33	30.00	90.00	-6.01			

***** DATA CARD NO. 8 RP 1 10 1 0 1.00000E+00 0.00000E-01 2.00000E+00 0.00000E-01 1.00000E+05 0.00000E-01

- - - RADIATED FIELDS NEAR GROUND - - -

- - - LOCATION - - -			- - E(THETA) - -		- - E(PHI) - -		- - E(RADIAL) - -	
RHO	PHI	Z	MAG	PHASE	MAG	PHASE	MAG	PHASE
METERS	DEGREES	METERS	VOLTS/M	DEGREES	VOLTS/M	DEGREES	VOLTS/M	DEGREES
100000.00	.00	1.00	2.3954E-09	142.02	0.0000E-01	.00	8.5944E-10	-46.49
100000.00	.00	3.00	2.7219E-09	164.40	0.0000E-01	.00	8.5934E-10	-46.49
100000.00	.00	5.00	3.3543E-09	-179.84	0.0000E-01	.00	8.5925E-10	-46.49
100000.00	.00	7.00	4.1558E-09	-169.57	0.0000E-01	.00	8.5915E-10	-46.49
100000.00	.00	9.00	5.0461E-09	-162.78	0.0000E-01	.00	8.5906E-10	-46.49
100000.00	.00	11.00	5.9861E-09	-158.07	0.0000E-01	.00	8.5896E-10	-46.49
100000.00	.00	13.00	6.9549E-09	-154.65	0.0000E-01	.00	8.5887E-10	-46.49
100000.00	.00	15.00	7.9428E-09	-152.08	0.0000E-01	.00	8.5877E-10	-46.49
100000.00	.00	17.00	8.9432E-09	-150.07	0.0000E-01	.00	8.5868E-10	-46.49
100000.00	.00	19.00	9.9514E-09	-148.48	0.0000E-01	.00	8.5858E-10	-46.49

***** DATA CARD NO. 9 EX 1 10 1 0 0.00000E-01 0.00000E-01 0.00000E-01 1.00000E+01 0.00000E-01 0.00000E-01
 ***** DATA CARD NO. 10 PT 2 0 5 5 0.00000E-01 0.00000E-01 0.00000E-01 0.00000E-01 0.00000E-01 0.00000E-01
 ***** DATA CARD NO. 11 XQ 0 0 0 0 0.00000E-01 0.00000E-01 0.00000E-01 0.00000E-01 0.00000E-01 0.00000E-01

- - - RECEIVING PATTERN PARAMETERS - - -

ETA= .00 DEGREES
 TYPE -LINEAR
 AXIAL RATIO= .000

THETA	PHI	- CURRENT -		SEG
(DEG)	(DEG)	MAGNITUDE	PHASE	NO.
.00	.00	0.0000E-01	.00	5
10.00	.00	6.2308E-03	-34.69	5
20.00	.00	1.1997E-02	-38.90	5
30.00	.00	1.6389E-02	-47.30	5
40.00	.00	1.8430E-02	-63.41	5
50.00	.00	1.9558E-02	-92.93	5
60.00	.00	2.5058E-02	-127.94	5
70.00	.00	3.2766E-02	-149.63	5
80.00	.00	2.9555E-02	-159.59	5
90.00	.00	9.7919E-09	35.39	5

- - - NORMALIZED RECEIVING PATTERN - - -

NORMALIZATION FACTOR= 3.2766E-02
 ETA= .00 DEGREES
 TYPE -LINEAR

AXIAL RATIO= .000
SEGMENT NO.= 5

THETA (DEG)	PHI (DEG)	- PATTERN - DB	MAGNITUDE
.00	.00	-999.99	0.0000E-01
10.00	.00	-14.42	1.9016E-01
20.00	.00	-8.73	3.6614E-01
30.00	.00	-6.02	5.0017E-01
40.00	.00	-5.00	5.6248E-01
50.00	.00	-4.48	5.9691E-01
60.00	.00	-2.33	7.6476E-01
70.00	.00	.00	1.0000E+00
80.00	.00	-.90	9.0201E-01
90.00	.00	-130.49	2.9884E-07

***** DATA CARD NO. 12 EN 0 0 0 0 0.00000E-01 0.00000E-01 0.00000E-01 0.00000E-01 0.00000E-01 0.00000E-01

RUN TIME = .000

Example 4

```

CEEEXAMPLE 4. T ANTENNA ON A BOX OVER PERFECT GROUND
SP 0 0 .1 .05 .05 0. 0. .01
SP 0 0 .05 .1 .05 0. 90. .01
GX 0 110
SP 0 0 0. 0. .1 90. 0. .04
GW 1 4 0. 0. .1 0. 0. .3 .001
GW 2 2 0. 0. .3 .15 0. .3 .001
GW 3 2 0. 0. .3 -.15 0. .3 .001
GE 1
GN 1
EX 0 1 1 0 1.
RP 0 10 4 1001 0. 0. 10. 30.
EN
    
```

1

```

*****
NUMERICAL ELECTROMAGNETICS CODE
*****
    
```

- - - - COMMENTS - - - -

EXAMPLE 4. T ANTENNA ON A BOX OVER PERFECT GROUND

- - - STRUCTURE SPECIFICATION - - -

COORDINATES MUST BE INPUT IN METERS OR BE SCALED TO METERS BEFORE STRUCTURE INPUT IS ENDED

WIRE NO.	X1	Y1	Z1	X2	Y2	Z2	RADIUS	NO. OF SEG.	FIRST SEG.	LAST SEG.	TAG NO.
1P	.10000	.05000	.05000	.00000	.00000	.01000					
2P	.05000	.10000	.05000	.00000	90.00000	.01000					
STRUCTURE REFLECTED ALONG THE AXES X Y . TAGS INCREMENTED BY 0											
9P	.00000	.00000	.10000	90.00000	.00000	.04000					
1	.00000	.00000	.10000	.00000	.00000	.30000	.00100	4	1	4	1
2	.00000	.00000	.30000	.15000	.00000	.30000	.00100	2	5	6	2
3	.00000	.00000	.30000	-.15000	.00000	.30000	.00100	2	7	8	3

GROUND PLANE SPECIFIED.

WHERE WIRE ENDS TOUCH GROUND, CURRENT WILL BE INTERPOLATED TO IMAGE IN GROUND PLANE.

TOTAL SEGMENTS USED= 8 NO. SEG. IN A SYMMETRIC CELL= 8 SYMMETRY FLAG= 0
 TOTAL PATCHES USED= 12 NO. PATCHES IN A SYMMETRIC CELL= 12

- MULTIPLE WIRE JUNCTIONS -

JUNCTION SEGMENTS (- FOR END 1, + FOR END 2)
 1 4 -5 -7

- - - - SEGMENTATION DATA - - - -

COORDINATES IN METERS

I+ AND I- INDICATE THE SEGMENTS BEFORE AND AFTER I

SEG. NO.	COORDINATES OF SEG. CENTER			SEG. LENGTH	ORIENTATION ANGLES		WIRE RADIUS	CONNECTION DATA			TAG NO.
	X	Y	Z		ALPHA	BETA		I-	I	I+	
1	.00000	.00000	.12500	.05000	90.00000	.00000	.00100	10009	1	2	1
2	.00000	.00000	.17500	.05000	90.00000	.00000	.00100		1	2	1
3	.00000	.00000	.22500	.05000	90.00000	.00000	.00100		2	3	1
4	.00000	.00000	.27500	.05000	90.00000	.00000	.00100		3	4	1
5	.03750	.00000	.30000	.07500	.00000	.00000	.00100	-7	5	6	2
6	.11250	.00000	.30000	.07500	.00000	.00000	.00100	5	6	0	2
7	-.03750	.00000	.30000	.07500	.00000	180.00000	.00100	4	7	8	3
8	-.11250	.00000	.30000	.07500	.00000	180.00000	.00100	7	8	0	3

--- SURFACE PATCH DATA ---

COORDINATES IN METERS

PATCH NO.	COORD. OF PATCH CENTER			UNIT NORMAL VECTOR			PATCH AREA	COMPONENTS OF UNIT TANGENT VECTORS					
	X	Y	Z	X	Y	Z		X1	Y1	Z1	X2	Y2	Z2
1	.10000	.05000	.05000	1.0000	.0000	-.0000	.01000	.0000	1.0000	.0000	.0000	-.0000	1.0000
2	.05000	.10000	.05000	0.0000	1.0000	.0000	.01000	-1.0000	0.0000	.0000	.0000	.0000	1.0000
3	.10000	-.05000	.05000	1.0000	-.0000	-.0000	.01000	.0000	-1.0000	.0000	.0000	.0000	1.0000
4	.05000	-.10000	.05000	0.0000	-1.0000	-.0000	.01000	-1.0000	0.0000	.0000	.0000	-.0000	1.0000
5	-.10000	.05000	.05000	-1.0000	-.0000	-.0000	.01000	-.0000	1.0000	.0000	.0000	-.0000	1.0000
6	-.05000	.10000	.05000	0.0000	1.0000	-.0000	.01000	1.0000	0.0000	.0000	-.0000	.0000	1.0000
7	-.10000	-.05000	.05000	-1.0000	.0000	-.0000	.01000	-.0000	-1.0000	.0000	-.0000	.0000	1.0000
8	-.05000	-.10000	.05000	0.0000	-1.0000	.0000	.01000	1.0000	0.0000	.0000	-.0000	-.0000	1.0000
9	.05000	.05000	.10000	-.0000	.0000	1.0000	.01000	1.0000	.0000	.0000	.0000	1.0000	-.0000
10	-.05000	.05000	.10000	-.0000	.0000	1.0000	.01000	1.0000	.0000	.0000	.0000	1.0000	-.0000
11	-.05000	-.05000	.10000	-.0000	.0000	1.0000	.01000	1.0000	.0000	.0000	.0000	1.0000	-.0000
12	.05000	-.05000	.10000	-.0000	.0000	1.0000	.01000	1.0000	.0000	.0000	.0000	1.0000	-.0000

***** DATA CARD NO. 1 GN 1 0 0 0 0.00000E-01 0.00000E-01 0.00000E-01 0.00000E-01 0.00000E-01 0.00000E-01
 ***** DATA CARD NO. 2 EX 0 1 1 0 1.00000E+00 0.00000E-01 0.00000E-01 0.00000E-01 0.00000E-01 0.00000E-01
 ***** DATA CARD NO. 3 RP 0 10 4 1001 0.00000E-01 0.00000E-01 1.00000E+01 3.00000E+01 0.00000E-01 0.00000E-01

--- FREQUENCY ---

FREQUENCY= 2.9980E+02 MHZ
 WAVELENGTH= 1.0000E+00 METERS

APPROXIMATE INTEGRATION EMPLOYED FOR SEGMENTS MORE THAN 1.000 WAVELENGTHS APART

--- STRUCTURE IMPEDANCE LOADING ---

THIS STRUCTURE IS NOT LOADED

--- ANTENNA ENVIRONMENT ---

PERFECT GROUND

--- MATRIX TIMING ---

FILL= .000 SEC., FACTOR= .000 SEC.

--- ANTENNA INPUT PARAMETERS ---

TAG NO.	SEG. NO.	VOLTAGE (VOLTS)		CURRENT (AMPS)		IMPEDANCE (OHMS)		ADMITTANCE (MHOS)		POWER (WATTS)
		REAL	IMAG.	REAL	IMAG.	REAL	IMAG.	REAL	IMAG.	
1	1	1.00000E+00	0.00000E-01	2.25807E-03	-2.71947E-03	1.80727E+02	2.17655E+02	2.25807E-03	-2.71947E-03	1.12904E-03

- - - CURRENTS AND LOCATION - - -

DISTANCES IN WAVELENGTHS

SEG. NO.	TAG NO.	COORD. OF SEG. CENTER			SEG. LENGTH	CURRENT (AMPS)			
		X	Y	Z		REAL	IMAG.	MAG.	PHASE
1	1	.0000	.0000	.1250	.05000	2.2581E-03	-2.7195E-03	3.5347E-03	-50.296
2	1	.0000	.0000	.1750	.05000	2.2309E-03	-3.4896E-03	4.1418E-03	-57.409
3	1	.0000	.0000	.2250	.05000	2.1622E-03	-3.9058E-03	4.4644E-03	-61.032
4	1	.0000	.0000	.2750	.05000	2.0278E-03	-3.8953E-03	4.3915E-03	-62.500
5	2	.0375	.0000	.3000	.07500	8.1382E-04	-1.5860E-03	1.7826E-03	-62.836
6	2	.1125	.0000	.3000	.07500	3.2206E-04	-6.4890E-04	7.2443E-04	-63.604
7	3	-.0375	.0000	.3000	.07500	8.1382E-04	-1.5860E-03	1.7826E-03	-62.836
8	3	-.1125	.0000	.3000	.07500	3.2206E-04	-6.4890E-04	7.2443E-04	-63.604

- - - SURFACE PATCH CURRENTS - - -

DISTANCE IN WAVELENGTHS
CURRENT IN AMPS/METER

PATCH NO.	PATCH CENTER			SURFACE COMPONENTS				RECTANGULAR COMPONENTS								
	X	Y	Z	TANGENT VECTOR 1 MAG.	PHASE	TANGENT VECTOR 2 MAG.	PHASE	REAL	X	IMAG.	REAL	Y	IMAG.	REAL	Z	IMAG.
1	.100	.050	.050	1.2095E-03	111.88	8.4058E-03	-115.75	-0.00E-01	0.00E-01	-4.51E-04	1.12E-03	-3.65E-03	-7.57E-03			
2	.050	.100	.050	1.2018E-03	-68.27	8.2434E-03	-116.57	-4.45E-04	1.12E-03	-1.94E-11	4.88E-11	-3.69E-03	-7.37E-03			
3	.100	-.050	.050	1.2095E-03	111.88	8.4058E-03	-115.75	-0.00E-01	0.00E-01	4.51E-04	-1.12E-03	-3.65E-03	-7.57E-03			
4	.050	-.100	.050	1.2018E-03	-68.27	8.2434E-03	-116.57	-4.45E-04	1.12E-03	1.94E-11	-4.88E-11	-3.69E-03	-7.37E-03			
5	-.100	.050	.050	1.2095E-03	111.88	8.4058E-03	-115.75	0.00E-01	0.00E-01	-4.51E-04	1.12E-03	-3.65E-03	-7.57E-03			
6	-.050	.100	.050	1.2017E-03	-68.27	8.2434E-03	-116.57	4.45E-04	-1.12E-03	-1.94E-11	4.88E-11	-3.69E-03	-7.37E-03			
7	-.100	-.050	.050	1.2095E-03	111.88	8.4058E-03	-115.75	0.00E-01	0.00E-01	4.51E-04	-1.12E-03	-3.65E-03	-7.57E-03			
8	-.050	-.100	.050	1.2017E-03	-68.27	8.2434E-03	-116.57	4.45E-04	-1.12E-03	1.94E-11	-4.88E-11	-3.69E-03	-7.37E-03			
9	.050	.050	.100	6.9791E-03	111.78	6.7774E-03	111.82	-2.59E-03	6.48E-03	-2.52E-03	6.29E-03	0.00E-01	0.00E-01			
10	-.050	.050	.100	6.9791E-03	-68.22	6.7774E-03	111.82	2.59E-03	-6.48E-03	-2.52E-03	6.29E-03	0.00E-01	-0.00E-01			
11	-.050	-.050	.100	6.9791E-03	-68.22	6.7774E-03	-68.18	2.59E-03	-6.48E-03	2.52E-03	-6.29E-03	0.00E-01	0.00E-01			
12	.050	-.050	.100	6.9791E-03	111.78	6.7774E-03	-68.18	-2.59E-03	6.48E-03	2.52E-03	-6.29E-03	-0.00E-01	0.00E-01			

- - - POWER BUDGET - - -

INPUT POWER = 1.1290E-03 WATTS
 RADIATED POWER= 1.1290E-03 WATTS
 STRUCTURE LOSS= 0.0000E-01 WATTS
 NETWORK LOSS = 0.0000E-01 WATTS
 EFFICIENCY = 100.00 PERCENT

- - - RADIATION PATTERNS - - -

- - ANGLES - -		- POWER GAINS -			- - - POLARIZATION - - -			- - - E(THETA) - - -		- - - E(PHI) - - -	
THETA DEGREES	PHI DEGREES	VERT. DB	HOR. DB	TOTAL DB	AXIAL RATIO	TILT DEG.	SENSE	MAGNITUDE VOLTS/M	PHASE DEGREES	MAGNITUDE VOLTS/M	PHASE DEGREES
.00	.00	-144.52	-146.03	-142.20	.10900	39.93	RIGHT	1.54659E-08	84.20	1.30020E-08	71.57
10.00	.00	-13.76	-144.43	-13.76	0.00000	0.00	LINEAR	5.33569E-02	-7.55	1.56265E-08	74.74
20.00	.00	-7.53	-144.77	-7.53	0.00000	0.00	LINEAR	1.09305E-01	-5.62	1.50174E-08	62.85
30.00	.00	-3.71	-145.47	-3.71	0.00000	0.00	LINEAR	1.69676E-01	-2.91	1.38587E-08	81.47
40.00	.00	-.90	-147.21	-.90	0.00000	0.00	LINEAR	2.34569E-01	.05	1.13432E-08	64.98
50.00	.00	1.28	-147.61	1.28	0.00000	0.00	LINEAR	3.01471E-01	2.82	1.08350E-08	71.57
60.00	.00	2.94	-150.97	2.94	0.00000	0.00	LINEAR	3.65091E-01	5.11	7.35666E-09	62.24
70.00	.00	4.12	-151.99	4.12	0.00000	0.00	LINEAR	4.18285E-01	6.79	6.54601E-09	96.01
80.00	.00	4.83	-164.60	4.83	0.00000	0.00	LINEAR	4.53809E-01	7.80	1.53231E-09	63.43
90.00	.00	5.07	-999.99	5.07	.00000	.00	LINEAR	4.66307E-01	8.13	0.00000E-01	.00
.00	30.00	-142.38	-156.09	-142.20	.10900	9.93	RIGHT	1.97887E-08	80.08	4.08122E-09	47.08
10.00	30.00	-14.02	-37.84	-14.00	.03737	-3.00	RIGHT	5.18064E-02	-8.73	3.33673E-03	-153.15
20.00	30.00	-7.78	-31.80	-7.76	.03466	-3.01	RIGHT	1.06290E-01	-6.67	6.69072E-03	-153.15
30.00	30.00	-3.93	-28.38	-3.92	.03042	-2.95	RIGHT	1.65480E-01	-3.75	9.91397E-03	-153.15

40.00	30.00	-1.08	-26.30	-1.07	.02517	-2.79	RIGHT	2.29786E-01	-.56	1.25926E-02	-153.15
50.00	30.00	1.15	-25.34	1.16	.01957	-2.47	RIGHT	2.96962E-01	2.42	1.40761E-02	-153.15
60.00	30.00	2.86	-25.59	2.87	.01412	-2.01	RIGHT	3.61722E-01	4.89	1.36726E-02	-153.15
70.00	30.00	4.09	-27.50	4.09	.00907	-1.42	RIGHT	4.16529E-01	6.68	1.09688E-02	-153.15
80.00	30.00	4.83	-32.55	4.83	.00442	-.73	RIGHT	4.53465E-01	7.77	6.13132E-03	-153.15
90.00	30.00	5.07	-165.86	5.07	0.00000	0.00	LINEAR	4.66523E-01	8.13	1.32478E-09	-70.18
.00	60.00	-142.78	-151.17	-142.20	.10900	-20.07	RIGHT	1.88818E-08	76.70	7.19216E-09	-84.40
10.00	60.00	-14.54	-37.83	-14.52	.04222	-3.09	RIGHT	4.87717E-02	-11.33	3.34127E-03	-153.15
20.00	60.00	-8.28	-31.75	-8.26	.03909	-3.12	RIGHT	1.00327E-01	-8.95	6.72501E-03	-153.16
30.00	60.00	-4.38	-28.29	-4.37	.03409	-3.09	RIGHT	1.57060E-01	-5.59	1.00184E-02	-153.18
40.00	60.00	-1.46	-26.16	-1.44	.02787	-2.92	RIGHT	2.20029E-01	-1.89	1.28028E-02	-153.19
50.00	60.00	.87	-25.14	.88	.02130	-2.59	RIGHT	2.87603E-01	1.57	1.43968E-02	-153.20
60.00	60.00	2.69	-25.35	2.70	.01508	-2.10	RIGHT	3.54582E-01	4.41	1.40578E-02	-153.21
70.00	60.00	4.01	-27.23	4.01	.00952	-1.47	RIGHT	4.12665E-01	6.48	1.13239E-02	-153.21
80.00	60.00	4.81	-32.26	4.81	.00458	-.76	RIGHT	4.52516E-01	7.72	6.34616E-03	-153.21
90.00	60.00	5.08	-154.24	5.08	0.00000	0.00	LINEAR	4.66738E-01	8.13	5.04750E-09	-10.39
.00	90.00	-146.03	-144.52	-142.20	.10900	-50.07	RIGHT	1.30020E-08	71.57	1.54659E-08	-95.80
10.00	90.00	-14.81	-143.13	-14.81	0.00000	0.00	LINEAR	4.72923E-02	-12.75	1.81421E-08	-93.80
20.00	90.00	-8.54	-143.32	-8.54	0.00000	0.00	LINEAR	9.73869E-02	-10.21	1.77559E-08	-94.18
30.00	90.00	-4.62	-144.80	-4.62	0.00000	0.00	LINEAR	1.52844E-01	-6.60	1.49726E-08	-103.04
40.00	90.00	-1.65	-143.77	-1.65	0.00000	0.00	LINEAR	2.15060E-01	-2.62	1.68649E-08	-104.74
50.00	90.00	.72	-149.34	.72	0.00000	0.00	LINEAR	2.82756E-01	1.11	8.87822E-09	-102.27
60.00	90.00	2.60	-147.14	2.60	0.00000	0.00	LINEAR	3.50811E-01	4.17	1.14368E-08	-101.96
70.00	90.00	3.96	-147.38	3.96	0.00000	0.00	LINEAR	4.10555E-01	6.38	1.11278E-08	-141.91
80.00	90.00	4.80	-156.95	4.80	0.00000	0.00	LINEAR	4.51911E-01	7.70	3.69785E-09	-150.45
90.00	90.00	5.08	-159.58	5.08	0.00000	0.00	LINEAR	4.66739E-01	8.14	2.73096E-09	-163.43

AVERAGE POWER GAIN= 1.79986E+00 SOLID ANGLE USED IN AVERAGING=(.5000)*PI STERADIANS.

***** DATA CARD NO. 4 EN 0 0 0 0 0 0.00000E-01 0.00000E-01 0.00000E-01 0.00000E-01 0.00000E-01 0.00000E-01

RUN TIME = .000

Example 5

Example 5 is a practical log-periodic antenna with 12 elements. Input data for the transmission line sections is printed in the table "Network Data." The table "Structure Excitation Data at Network connection Points" contains the voltage, current impedance, admittance, and power in each segment to which transmission lines or network connect. This segment current will differ from the current into the connection transmission line if there are other transmission lines, network ports, or a voltage source providing alternate current paths. Thus, the current printed here for segment 3 differs from that in the table antenna "Input Parameters." The latter is the current through the voltage source and includes the current into the segment and into the transmission line. Power listed in the network-connection table is the power being fed into the segment. A negative power indicates that the structure is feeding power into the network or transmission line.

With 78 segments, file storage must be used for the interaction matrix. The line after data card number 14 shows how the matrix has been divided into blocks for transfer between core and the files. The line "CP TIME TAKEN FOR FACTORIZATION," gives the amount of central processor time used to factor the matrix excluding time spent transferring data between core and the files.

The EX card option has been used to print the relative asymmetry of the driving-point admittance matrix. The driving-point admittance matrix is the matrix of self and mutual admittances of segments connected to transmission lines, network ports, or voltage sources and should be symmetric.

Input Card Deck:

```

CM 12 ELEMENT LOG PERIODIC ANTENNA IN FREE SPACE
CM 78 SEGMENTS. SIGMA=O/L RECEIVING AND TRANS. PATTERNS.
CM DIPOLE LENGTH TO DIAMETER RATIO=150.
CE TAU=0.93. SIGMA=0.70. BOOM IMPEDANCE=50. OHMS.
GW 1 5 0.0000 -1.0000 0.0000000 0.00000 1.0000 0.000 .00667
GW 2 5 -.7527 -1.0753 0. -.7527 1.0753 0. .00717
GW 3 5 -1.562 -1.1562 0. -1.562 1.1562 0. .00771
GW 4 5 -2.4323 -1.2432 0. -2.4323 1.2432 0. .00829
GW 5 5 -3.368 -1.3368 0. -3.368 1.3368 0. .00891
GW 6 7 -4.3742 -1.4374 0. -4.3742 1.4374 0. .00958
GW 7 7 -5.4562 -1.5456 0. -5.4562 1.5456 0. .0103
GW 8 7 -6.6195 -1.6619 0. -6.6195 1.6619 0. .01108
GW 9 7 -7.8705 -1.787 0. -7.8705 1.787 0. .01191
GW 10 7 -9.2156 -1.9215 0. -9.2156 1.9215 0. .01281
GW 11 9 -10.6619 -2.0662 0. -10.6619 2.0662 0. .01377
GW 12 9 -12.2171 -2.2217 0. -12.2171 2.2217 0. .01481
GE
FR 0 0 0 0 46.29 0.
TL 1 3 2 3 -50.
TL 2 3 3 3 -50.
TL 3 3 4 3 -50.
TL 4 3 5 3 -50.
TL 5 3 6 4 -50.
TL 6 4 7 4 -50.
TL 7 4 8 4 -50.
TL 8 4 9 4 -50.
TL 9 4 10 4 -50.
TL 10 4 11 5 -50.
TL 11 5 12 5 -50. ,0.,0.,.02
EX 0 1 3 10 1
RP 0 37 1 1110 90. 0. -5. 0.
EN
    
```

Line-Printer Output:

1

 NUMERICAL ELECTROMAGNETICS CODE

- - - COMMENTS - - -

12 ELEMENT LOG PERIODIC ANTENNA IN FREE SPACE
 78 SEGMENTS. SIGMA=0/L RECEIVING AND TRANS. PATTERNS.
 DIPOLE LENGTH TO DIAMETER RATIO=150.
 TAU=0.93. SIGMA=0.70. BOOM IMPEDANCE=50. OHMS.

- - - STRUCTURE SPECIFICATION - - -

COORDINATES MUST BE INPUT IN
 METERS OR BE SCALED TO METERS
 BEFORE STRUCTURE INPUT IS ENDED

WIRE NO.	X1	Y1	Z1	X2	Y2	Z2	RADIUS	NO. OF SEG.	FIRST SEG.	LAST SEG.	TAG NO.
1	.00000	-1.00000	.00000	.00000	1.00000	.00000	.00667	5	1	5	1
2	-.75270	-1.07530	.00000	-.75270	1.07530	.00000	.00717	5	6	10	2
3	-1.56200	-1.15620	.00000	-1.56200	1.15620	.00000	.00771	5	11	15	3
4	-2.43230	-1.24320	.00000	-2.43230	1.24320	.00000	.00829	5	16	20	4
5	-3.36800	-1.33680	.00000	-3.36800	1.33680	.00000	.00891	5	21	25	5
6	-4.37420	-1.43740	.00000	-4.37420	1.43740	.00000	.00958	7	26	32	6
7	-5.45620	-1.54560	.00000	-5.45620	1.54560	.00000	.01030	7	33	39	7
8	-6.61950	-1.66190	.00000	-6.61950	1.66190	.00000	.01108	7	40	46	8
9	-7.87050	-1.78700	.00000	-7.87050	1.78700	.00000	.01191	7	47	53	9
10	-9.21560	-1.92150	.00000	-9.21560	1.92150	.00000	.01281	7	54	60	10
11	-10.66190	-2.06620	.00000	-10.66190	2.06620	.00000	.01377	9	61	69	11
12	-12.21710	-2.22170	.00000	-12.21710	2.22170	.00000	.01481	9	70	78	12

TOTAL SEGMENTS USED= 78 NO. SEG. IN A SYMMETRIC CELL= 78 SYMMETRY FLAG= 0

- MULTIPLE WIRE JUNCTIONS -
 JUNCTION SEGMENTS (- FOR END 1, + FOR END 2)
 NONE

- - - SEGMENTATION DATA - - -

COORDINATES IN METERS

I+ AND I- INDICATE THE SEGMENTS BEFORE AND AFTER I

SEG. NO.	COORDINATES OF SEG. CENTER			SEG. LENGTH	ORIENTATION ANGLES		WIRE RADIUS	CONNECTION DATA			TAG NO.
	X	Y	Z		ALPHA	BETA		I-	I	I+	
1	.00000	-.80000	.00000	.40000	.00000	90.00000	.00667	0	1	2	1
2	.00000	-.40000	.00000	.40000	.00000	90.00000	.00667	1	2	3	1
3	.00000	0.00000	.00000	.40000	.00000	90.00000	.00667	2	3	4	1
4	.00000	.40000	.00000	.40000	.00000	90.00000	.00667	3	4	5	1
5	.00000	.80000	.00000	.40000	.00000	90.00000	.00667	4	5	0	1
6	-.75270	-.86024	.00000	.43012	.00000	90.00000	.00717	0	6	7	2
7	-.75270	-.43012	.00000	.43012	.00000	90.00000	.00717	6	7	8	2
8	-.75270	.00000	.00000	.43012	.00000	90.00000	.00717	7	8	9	2
9	-.75270	.43012	.00000	.43012	.00000	90.00000	.00717	8	9	10	2
10	-.75270	.86024	.00000	.43012	.00000	90.00000	.00717	9	10	0	2
11	-1.56200	-.92496	.00000	.46248	.00000	90.00000	.00771	0	11	12	3
12	-1.56200	-.46248	.00000	.46248	.00000	90.00000	.00771	11	12	13	3
13	-1.56200	0.00000	.00000	.46248	.00000	90.00000	.00771	12	13	14	3
14	-1.56200	.46248	.00000	.46248	.00000	90.00000	.00771	13	14	15	3
15	-1.56200	.92496	.00000	.46248	.00000	90.00000	.00771	14	15	0	3
16	-2.43230	-.99456	.00000	.49728	.00000	90.00000	.00829	0	16	17	4

17	-2.43230	-.49728	.00000	.49728	.00000	90.00000	.00829	16	17	18	4
18	-2.43230	0.00000	.00000	.49728	.00000	90.00000	.00829	17	18	19	4
19	-2.43230	.49728	.00000	.49728	.00000	90.00000	.00829	18	19	20	4
20	-2.43230	.99456	.00000	.49728	.00000	90.00000	.00829	19	20	0	4
21	-3.36800	-1.06944	.00000	.53472	.00000	90.00000	.00891	0	21	22	5
22	-3.36800	-.53472	.00000	.53472	.00000	90.00000	.00891	21	22	23	5
23	-3.36800	0.00000	.00000	.53472	.00000	90.00000	.00891	22	23	24	5
24	-3.36800	.53472	.00000	.53472	.00000	90.00000	.00891	23	24	25	5
25	-3.36800	1.06944	.00000	.53472	.00000	90.00000	.00891	24	25	0	5
26	-4.37420	-1.23206	.00000	.41069	.00000	90.00000	.00958	0	26	27	6
27	-4.37420	-.82137	.00000	.41069	.00000	90.00000	.00958	26	27	28	6
28	-4.37420	-.41069	.00000	.41069	.00000	90.00000	.00958	27	28	29	6
29	-4.37420	0.00000	.00000	.41069	.00000	90.00000	.00958	28	29	30	6
30	-4.37420	.41069	.00000	.41069	.00000	90.00000	.00958	29	30	31	6
31	-4.37420	.82137	.00000	.41069	.00000	90.00000	.00958	30	31	32	6
32	-4.37420	1.23206	.00000	.41069	.00000	90.00000	.00958	31	32	0	6
33	-5.45620	-1.32480	.00000	.44160	.00000	90.00000	.01030	0	33	34	7
34	-5.45620	-.88320	.00000	.44160	.00000	90.00000	.01030	33	34	35	7
35	-5.45620	-.44160	.00000	.44160	.00000	90.00000	.01030	34	35	36	7
36	-5.45620	0.00000	.00000	.44160	.00000	90.00000	.01030	35	36	37	7
37	-5.45620	.44160	.00000	.44160	.00000	90.00000	.01030	36	37	38	7
38	-5.45620	.88320	.00000	.44160	.00000	90.00000	.01030	37	38	39	7
39	-5.45620	1.32480	.00000	.44160	.00000	90.00000	.01030	38	39	0	7
40	-6.61950	-1.42449	.00000	.47483	.00000	90.00000	.01108	0	40	41	8
41	-6.61950	-.94966	.00000	.47483	.00000	90.00000	.01108	40	41	42	8
42	-6.61950	-.47483	.00000	.47483	.00000	90.00000	.01108	41	42	43	8
43	-6.61950	0.00000	.00000	.47483	.00000	90.00000	.01108	42	43	44	8
44	-6.61950	.47483	.00000	.47483	.00000	90.00000	.01108	43	44	45	8
45	-6.61950	.94966	.00000	.47483	.00000	90.00000	.01108	44	45	46	8
46	-6.61950	1.42449	.00000	.47483	.00000	90.00000	.01108	45	46	0	8
47	-7.87050	-1.53171	.00000	.51057	.00000	90.00000	.01191	0	47	48	9
48	-7.87050	-1.02114	.00000	.51057	.00000	90.00000	.01191	47	48	49	9
49	-7.87050	-.51057	.00000	.51057	.00000	90.00000	.01191	48	49	50	9
50	-7.87050	0.00000	.00000	.51057	.00000	90.00000	.01191	49	50	51	9
51	-7.87050	.51057	.00000	.51057	.00000	90.00000	.01191	50	51	52	9
52	-7.87050	1.02114	.00000	.51057	.00000	90.00000	.01191	51	52	53	9
53	-7.87050	1.53171	.00000	.51057	.00000	90.00000	.01191	52	53	0	9
54	-9.21560	-1.64700	.00000	.54900	.00000	90.00000	.01281	0	54	55	10
55	-9.21560	-1.09800	.00000	.54900	.00000	90.00000	.01281	54	55	56	10
56	-9.21560	-.54900	.00000	.54900	.00000	90.00000	.01281	55	56	57	10
57	-9.21560	0.00000	.00000	.54900	.00000	90.00000	.01281	56	57	58	10
58	-9.21560	.54900	.00000	.54900	.00000	90.00000	.01281	57	58	59	10
59	-9.21560	1.09800	.00000	.54900	.00000	90.00000	.01281	58	59	60	10
60	-9.21560	1.64700	.00000	.54900	.00000	90.00000	.01281	59	60	0	10
61	-10.66190	-1.83662	.00000	.45916	.00000	90.00000	.01377	0	61	62	11
62	-10.66190	-1.37747	.00000	.45916	.00000	90.00000	.01377	61	62	63	11
63	-10.66190	-.91831	.00000	.45916	.00000	90.00000	.01377	62	63	64	11
64	-10.66190	-.45916	.00000	.45916	.00000	90.00000	.01377	63	64	65	11
65	-10.66190	.00000	.00000	.45916	.00000	90.00000	.01377	64	65	66	11
66	-10.66190	.45916	.00000	.45916	.00000	90.00000	.01377	65	66	67	11
67	-10.66190	.91831	.00000	.45916	.00000	90.00000	.01377	66	67	68	11
68	-10.66190	1.37747	.00000	.45916	.00000	90.00000	.01377	67	68	69	11
69	-10.66190	1.83662	.00000	.45916	.00000	90.00000	.01377	68	69	0	11
70	-12.21710	-1.97484	.00000	.49371	.00000	90.00000	.01481	0	70	71	12
71	-12.21710	-1.48113	.00000	.49371	.00000	90.00000	.01481	70	71	72	12
72	-12.21710	-.98742	.00000	.49371	.00000	90.00000	.01481	71	72	73	12
73	-12.21710	-.49371	.00000	.49371	.00000	90.00000	.01481	72	73	74	12
74	-12.21710	0.00000	.00000	.49371	.00000	90.00000	.01481	73	74	75	12
75	-12.21710	.49371	.00000	.49371	.00000	90.00000	.01481	74	75	76	12
76	-12.21710	.98742	.00000	.49371	.00000	90.00000	.01481	75	76	77	12
77	-12.21710	1.48113	.00000	.49371	.00000	90.00000	.01481	76	77	78	12
78	-12.21710	1.97484	.00000	.49371	.00000	90.00000	.01481	77	78	0	12

*****	DATA CARD NO.	1	FR	0	0	0	0	4.62900E+01	0.00000E-01	0.00000E-01	0.00000E-01	0.00000E-01	0.00000E-01	0.00000E-01	0.00000E-01
*****	DATA CARD NO.	2	TL	1	3	2	3	-5.00000E+01	0.00000E-01	0.00000E-01	0.00000E-01	0.00000E-01	0.00000E-01	0.00000E-01	0.00000E-01
*****	DATA CARD NO.	3	TL	2	3	3	3	-5.00000E+01	0.00000E-01	0.00000E-01	0.00000E-01	0.00000E-01	0.00000E-01	0.00000E-01	0.00000E-01
*****	DATA CARD NO.	4	TL	3	3	4	3	-5.00000E+01	0.00000E-01	0.00000E-01	0.00000E-01	0.00000E-01	0.00000E-01	0.00000E-01	0.00000E-01
*****	DATA CARD NO.	5	TL	4	3	5	3	-5.00000E+01	0.00000E-01	0.00000E-01	0.00000E-01	0.00000E-01	0.00000E-01	0.00000E-01	0.00000E-01
*****	DATA CARD NO.	6	TL	5	3	6	4	-5.00000E+01	0.00000E-01	0.00000E-01	0.00000E-01	0.00000E-01	0.00000E-01	0.00000E-01	0.00000E-01
*****	DATA CARD NO.	7	TL	6	4	7	4	-5.00000E+01	0.00000E-01	0.00000E-01	0.00000E-01	0.00000E-01	0.00000E-01	0.00000E-01	0.00000E-01
*****	DATA CARD NO.	8	TL	7	4	8	4	-5.00000E+01	0.00000E-01	0.00000E-01	0.00000E-01	0.00000E-01	0.00000E-01	0.00000E-01	0.00000E-01
*****	DATA CARD NO.	9	TL	8	4	9	4	-5.00000E+01	0.00000E-01	0.00000E-01	0.00000E-01	0.00000E-01	0.00000E-01	0.00000E-01	0.00000E-01
*****	DATA CARD NO.	10	TL	9	4	10	4	-5.00000E+01	0.00000E-01	0.00000E-01	0.00000E-01	0.00000E-01	0.00000E-01	0.00000E-01	0.00000E-01
*****	DATA CARD NO.	11	TL	10	4	11	5	-5.00000E+01	0.00000E-01	0.00000E-01	0.00000E-01	0.00000E-01	0.00000E-01	0.00000E-01	0.00000E-01
*****	DATA CARD NO.	12	TL	11	5	12	5	-5.00000E+01	0.00000E-01	0.00000E-01	0.00000E-01	0.00000E-01	2.00000E-02	0.00000E-01	0.00000E-01
*****	DATA CARD NO.	13	EX	0	1	3	10	1.00000E+00	0.00000E-01	0.00000E-01	0.00000E-01	0.00000E-01	0.00000E-01	0.00000E-01	0.00000E-01
*****	DATA CARD NO.	14	RP	0	37	1	1110	9.00000E+01	0.00000E-01	-5.00000E+00	0.00000E-01	0.00000E-01	0.00000E-01	0.00000E-01	0.00000E-01

- - - - - FREQUENCY - - - - -

FREQUENCY= 4.6290E+01 MHZ
 WAVELENGTH= 6.4766E+00 METERS

APPROXIMATE INTEGRATION EMPLOYED FOR SEGMENTS MORE THAN 1.000 WAVELENGTHS APART

- - - STRUCTURE IMPEDANCE LOADING - - -

THIS STRUCTURE IS NOT LOADED

- - - ANTENNA ENVIRONMENT - - -

FREE SPACE

- - - MATRIX TIMING - - -

FILL= .000 SEC., FACTOR= .000 SEC.

- - - NETWORK DATA - - -

- FROM -		- TO -		TRANSMISSION LINE		- - SHUNT ADMITTANCES (MHOS) - -				LINE
TAG	SEG.	TAG	SEG.	IMPEDANCE	LENGTH	- END ONE -		- END TWO -		TYPE
NO.	NO.	NO.	NO.	OHM'S	METERS	REAL	IMAG.	REAL	IMAG.	
1	3	2	8	5.0000E+01	7.5270E-01	0.0000E-01	0.0000E-01	0.0000E-01	0.0000E-01	CROSSED
2	8	3	13	5.0000E+01	8.0930E-01	0.0000E-01	0.0000E-01	0.0000E-01	0.0000E-01	CROSSED
3	13	4	18	5.0000E+01	8.7030E-01	0.0000E-01	0.0000E-01	0.0000E-01	0.0000E-01	CROSSED
4	18	5	23	5.0000E+01	9.3570E-01	0.0000E-01	0.0000E-01	0.0000E-01	0.0000E-01	CROSSED
5	23	6	29	5.0000E+01	1.0062E+00	0.0000E-01	0.0000E-01	0.0000E-01	0.0000E-01	CROSSED
6	29	7	36	5.0000E+01	1.0820E+00	0.0000E-01	0.0000E-01	0.0000E-01	0.0000E-01	CROSSED
7	36	8	43	5.0000E+01	1.1633E+00	0.0000E-01	0.0000E-01	0.0000E-01	0.0000E-01	CROSSED
8	43	9	50	5.0000E+01	1.2510E+00	0.0000E-01	0.0000E-01	0.0000E-01	0.0000E-01	CROSSED
9	50	10	57	5.0000E+01	1.3451E+00	0.0000E-01	0.0000E-01	0.0000E-01	0.0000E-01	CROSSED
10	57	11	65	5.0000E+01	1.4463E+00	0.0000E-01	0.0000E-01	0.0000E-01	0.0000E-01	CROSSED
11	65	12	74	5.0000E+01	1.5552E+00	0.0000E-01	0.0000E-01	2.0000E-02	0.0000E-01	CROSSED

MAXIMUM RELATIVE ASYMMETRY OF THE DRIVING POINT ADMITTANCE MATRIX IS 1.073E-02 FOR SEGMENTS 65 AND 23
 RMS RELATIVE ASYMMETRY IS 5.722E-03

- - - STRUCTURE EXCITATION DATA AT NETWORK CONNECTION POINTS - - -

TAG	SEG.	VOLTAGE (VOLTS)		CURRENT (AMPS)		IMPEDANCE (OHMS)		ADMITTANCE (MHOS)		POWER
NO.	NO.	REAL	IMAG.	REAL	IMAG.	REAL	IMAG.	REAL	IMAG.	(WATTS)
2	8	-6.76616E-01	7.27107E-01	-1.87448E-04	-1.90086E-03	-3.44068E+02	-3.89883E+02	-1.27248E-03	1.44192E-03	-6.27648E-04
3	13	-1.14179E-01	-1.08175E+00	6.83832E-03	2.28689E-03	-6.25982E+01	-1.37256E+02	-2.75065E-03	6.03119E-03	-1.62732E-03
4	18	9.62183E-01	5.03150E-01	-4.58059E-03	1.06832E-02	7.16349E+00	-9.31369E+01	8.20955E-04	1.06737E-02	4.83935E-04
5	23	-7.24713E-01	6.58962E-01	-1.37152E-02	-3.48003E-03	3.81905E+01	-5.77365E+01	7.96961E-03	1.20485E-02	3.82318E-03
6	29	-2.80596E-01	-7.56236E-01	1.69124E-03	-1.27472E-02	5.54295E+01	-2.93665E+01	1.40869E-02	7.46324E-03	4.58267E-03
7	36	5.10270E-01	5.67761E-02	9.62865E-03	-1.20107E-03	5.14587E+01	1.23155E+01	1.83803E-02	-4.39892E-03	2.42251E-03
8	43	-2.44964E-01	2.99215E-01	1.37879E-03	5.04751E-03	4.28271E+01	6.02303E+01	7.84113E-03	-1.10275E-02	5.86270E-04
9	50	-9.81928E-02	-3.60792E-01	-2.30707E-03	5.52838E-04	4.81112E+00	1.57539E+02	1.93672E-04	-6.34174E-03	1.35389E-05
10	57	3.40100E-01	2.78461E-02	3.63826E-04	-9.09073E-04	1.02654E+02	3.33033E+02	8.45245E-04	-2.74216E-03	4.92115E-05
11	65	-9.25478E-02	3.38625E-01	5.72652E-04	5.66045E-04	2.13900E+02	3.79895E+02	1.12535E-03	-1.99868E-03	6.93396E-05
12	74	-2.94654E-01	-1.34965E-01	-7.24811E-04	4.78766E-04	1.97400E+02	3.16598E+02	1.41809E-03	-2.27439E-03	7.44759E-05
1	3	1.00000E+00	0.00000E-01	1.82304E-03	2.30145E-03	2.11486E+02	-2.66986E+02	1.82304E-03	2.30145E-03	9.11518E-04

- - - ANTENNA INPUT PARAMETERS - - -

TAG	SEG.	VOLTAGE (VOLTS)		CURRENT (AMPS)		IMPEDANCE (OHMS)		ADMITTANCE (MHOS)		POWER
NO.	NO.	REAL	IMAG.	REAL	IMAG.	REAL	IMAG.	REAL	IMAG.	(WATTS)
1	3	1.00000E+00	0.00000E-01	2.36241E-02	2.50358E-04	4.23249E+01	-4.48542E-01	2.36241E-02	2.50358E-04	1.18120E-02

- - - CURRENTS AND LOCATION - - -

DISTANCES IN WAVELENGTHS

SEG. NO.	TAG NO.	COORD. OF SEG. CENTER			SEG. LENGTH	CURRENT (AMPS)			PHASE
		X	Y	Z		REAL	IMAG.	MAG.	
1	1	.0000	-.1235	.0000	.06176	6.9701E-04	5.6831E-04	8.9933E-04	39.192
2	1	.0000	-.0618	.0000	.06176	1.5441E-03	1.5715E-03	2.2031E-03	45.505
3	1	.0000	0.0000	.0000	.06176	1.8230E-03	2.3015E-03	2.9360E-03	51.616
4	1	.0000	.0618	.0000	.06176	1.5441E-03	1.5715E-03	2.2031E-03	45.505
5	1	.0000	.1235	.0000	.06176	6.9701E-04	5.6831E-04	8.9933E-04	39.192
6	2	-.1162	-.1328	.0000	.06641	1.9927E-04	-4.7369E-04	5.1389E-04	-67.185
7	2	-.1162	-.0664	.0000	.06641	1.5391E-04	-1.3187E-03	1.3277E-03	-83.343
8	2	-.1162	.0000	.0000	.06641	-1.8745E-04	-1.9009E-03	1.9101E-03	-95.632
9	2	-.1162	.0664	.0000	.06641	1.5391E-04	-1.3187E-03	1.3277E-03	-83.343
10	2	-.1162	.1328	.0000	.06641	1.9927E-04	-4.7369E-04	5.1389E-04	-67.185
11	3	-.2412	-.1428	.0000	.07141	2.1564E-03	9.2255E-04	2.3455E-03	23.162
12	3	-.2412	-.0714	.0000	.07141	5.2787E-03	1.9920E-03	5.6420E-03	20.675
13	3	-.2412	0.0000	.0000	.07141	6.8383E-03	2.2869E-03	7.2106E-03	18.491
14	3	-.2412	.0714	.0000	.07141	5.2786E-03	1.9920E-03	5.6420E-03	20.675
15	3	-.2412	.1428	.0000	.07141	2.1564E-03	9.2255E-04	2.3455E-03	23.162
16	4	-.3756	-.1536	.0000	.07678	-1.5100E-03	3.5736E-03	3.8795E-03	112.907
17	4	-.3756	-.0768	.0000	.07678	-3.6154E-03	8.5166E-03	9.2522E-03	113.002
18	4	-.3756	0.0000	.0000	.07678	-4.5806E-03	1.0683E-02	1.1624E-02	113.208
19	4	-.3756	.0768	.0000	.07678	-3.6154E-03	8.5165E-03	9.2522E-03	113.002
20	4	-.3756	.1536	.0000	.07678	-1.5100E-03	3.5736E-03	3.8795E-03	112.907
21	5	-.5200	-.1651	.0000	.08256	-4.7273E-03	-9.5638E-04	4.8231E-03	-168.563
22	5	-.5200	-.0826	.0000	.08256	-1.1146E-02	-2.5350E-03	1.1431E-02	-167.187
23	5	-.5200	0.0000	.0000	.08256	-1.3715E-02	-3.4800E-03	1.4150E-02	-165.762
24	5	-.5200	.0826	.0000	.08256	-1.1146E-02	-2.5350E-03	1.1431E-02	-167.187
25	5	-.5200	.1651	.0000	.08256	-4.7273E-03	-9.5638E-04	4.8231E-03	-168.563
26	6	-.6754	-.1902	.0000	.06341	1.3731E-04	-3.3822E-03	3.3850E-03	-87.675
27	6	-.6754	-.1268	.0000	.06341	5.5799E-04	-8.3198E-03	8.3385E-03	-86.163
28	6	-.6754	-.0634	.0000	.06341	1.1473E-03	-1.1516E-02	1.1573E-02	-84.311
29	6	-.6754	0.0000	.0000	.06341	1.6912E-03	-1.2747E-02	1.2859E-02	-82.442
30	6	-.6754	.0634	.0000	.06341	1.1473E-03	-1.1516E-02	1.1573E-02	-84.311
31	6	-.6754	.1268	.0000	.06341	5.5799E-04	-8.3199E-03	8.3385E-03	-86.163
32	6	-.6754	.1902	.0000	.06341	1.3731E-04	-3.3822E-03	3.3850E-03	-87.675
33	7	-.8425	-.2046	.0000	.06818	2.5954E-03	-5.7116E-04	2.6575E-03	-12.411
34	7	-.8425	-.1364	.0000	.06818	6.4066E-03	-1.2268E-03	6.5230E-03	-10.840
35	7	-.8425	-.0682	.0000	.06818	8.8142E-03	-1.3925E-03	8.9235E-03	-8.978
36	7	-.8425	0.0000	.0000	.06818	9.6287E-03	-1.2011E-03	9.7033E-03	-7.110
37	7	-.8425	.0682	.0000	.06818	8.8142E-03	-1.3925E-03	8.9235E-03	-8.978
38	7	-.8425	.1364	.0000	.06818	6.4066E-03	-1.2268E-03	6.5230E-03	-10.840
39	7	-.8425	.2046	.0000	.06818	2.5954E-03	-5.7116E-04	2.6575E-03	-12.411
40	8	-1.0221	-.2199	.0000	.07331	5.2466E-04	1.4101E-03	1.5045E-03	69.591
41	8	-1.0221	-.1466	.0000	.07331	1.1847E-03	3.4847E-03	3.6806E-03	71.223
42	8	-1.0221	-.0733	.0000	.07331	1.4458E-03	4.7321E-03	4.9480E-03	73.011
43	8	-1.0221	0.0000	.0000	.07331	1.3788E-03	5.0475E-03	5.2324E-03	74.722
44	8	-1.0221	.0733	.0000	.07331	1.4458E-03	4.7321E-03	4.9480E-03	73.011
45	8	-1.0221	.1466	.0000	.07331	1.1847E-03	3.4847E-03	3.6806E-03	71.223
46	8	-1.0221	.2199	.0000	.07331	5.2466E-04	1.4101E-03	1.5045E-03	69.591
47	9	-1.2152	-.2365	.0000	.07883	-7.4266E-04	2.0200E-04	7.6964E-04	164.784
48	9	-1.2152	-.1577	.0000	.07883	-1.7935E-03	4.6191E-04	1.8521E-03	165.558
49	9	-1.2152	-.0788	.0000	.07883	-2.3192E-03	5.7096E-04	2.3884E-03	166.169
50	9	-1.2152	0.0000	.0000	.07883	-2.3071E-03	5.5284E-04	2.3724E-03	166.524
51	9	-1.2152	.0788	.0000	.07883	-2.3192E-03	5.7096E-04	2.3884E-03	166.169
52	9	-1.2152	.1577	.0000	.07883	-1.7935E-03	4.6191E-04	1.8521E-03	165.558
53	9	-1.2152	.2365	.0000	.07883	-7.4266E-04	2.0200E-04	7.6964E-04	164.784
54	10	-1.4229	-.2543	.0000	.08477	9.5743E-05	-3.9087E-04	4.0242E-04	-76.236
55	10	-1.4229	-.1695	.0000	.08477	2.4938E-04	-8.9773E-04	9.3173E-04	-74.475
56	10	-1.4229	-.0848	.0000	.08477	3.4515E-04	-1.0563E-03	1.1113E-03	-71.906
57	10	-1.4229	0.0000	.0000	.08477	3.6383E-04	-9.0907E-04	9.7917E-04	-68.188
58	10	-1.4229	.0848	.0000	.08477	3.4515E-04	-1.0563E-03	1.1113E-03	-71.906
59	10	-1.4229	.1695	.0000	.08477	2.4938E-04	-8.9773E-04	9.3173E-04	-74.475
60	10	-1.4229	.2543	.0000	.08477	9.5743E-05	-3.9087E-04	4.0242E-04	-76.236
61	11	-1.6462	-.2836	.0000	.07089	2.7079E-04	1.5010E-04	3.0961E-04	28.999
62	11	-1.6462	-.2127	.0000	.07089	6.3252E-04	3.7761E-04	7.3667E-04	30.837
63	11	-1.6462	-.1418	.0000	.07089	8.0839E-04	5.3276E-04	9.6816E-04	33.386
64	11	-1.6462	-.0709	.0000	.07089	7.6874E-04	5.9415E-04	9.7159E-04	37.700
65	11	-1.6462	.0000	.0000	.07089	5.7265E-04	5.6604E-04	8.0519E-04	44.668
66	11	-1.6462	.0709	.0000	.07089	7.6874E-04	5.9415E-04	9.7158E-04	37.700
67	11	-1.6462	.1418	.0000	.07089	8.0839E-04	5.3276E-04	9.6815E-04	33.386
68	11	-1.6462	.2127	.0000	.07089	6.3252E-04	3.7761E-04	7.3666E-04	30.837
69	11	-1.6462	.2836	.0000	.07089	2.7079E-04	1.5010E-04	3.0960E-04	28.999
70	12	-1.8864	-.3049	.0000	.07623	-1.9982E-04	2.4071E-04	3.1284E-04	129.697
71	12	-1.8864	-.2287	.0000	.07623	-5.0500E-04	5.6306E-04	7.5635E-04	131.888
72	12	-1.8864	-.1525	.0000	.07623	-7.0915E-04	7.1496E-04	1.0070E-03	134.767
73	12	-1.8864	-.0762	.0000	.07623	-7.7879E-04	6.6719E-04	1.0255E-03	139.413
74	12	-1.8864	0.0000	.0000	.07623	-7.2481E-04	4.7877E-04	8.6866E-04	146.554
75	12	-1.8864	.0762	.0000	.07623	-7.7879E-04	6.6719E-04	1.0255E-03	139.413
76	12	-1.8864	.1525	.0000	.07623	-7.0915E-04	7.1496E-04	1.0070E-03	134.767
77	12	-1.8864	.2287	.0000	.07623	-5.0500E-04	5.6306E-04	7.5635E-04	131.888
78	12	-1.8864	.3049	.0000	.07623	-1.9982E-04	2.4071E-04	3.1284E-04	129.697

- - - POWER BUDGET - - -

INPUT POWER = 1.1812E-02 WATTS
 RADIATED POWER= 1.0762E-02 WATTS
 STRUCTURE LOSS= 0.0000E-01 WATTS
 NETWORK LOSS = 1.0504E-03 WATTS
 EFFICIENCY = 91.11 PERCENT

- - - RADIATION PATTERNS - - -

- - ANGLES - -		- DIRECTIVE GAINS -			- - - POLARIZATION - - -			- - - E(THETA) - - -		- - - E(PHI) - - -	
THETA	PHI	VERT.	HOR.	TOTAL	AXIAL	TILT	SENSE	MAGNITUDE	PHASE	MAGNITUDE	PHASE
DEGREES	DEGREES	DB	DB	DB	RATIO	DEG.		VOLTS/M	DEGREES	VOLTS/M	DEGREES
90.00	.00	-999.99	9.75	9.75	.00000	90.00	LINEAR	0.00000E-01	.00	2.46922E+00	-66.00
85.00	.00	-999.99	9.70	9.70	.00000	90.00	LINEAR	0.00000E-01	.00	2.45353E+00	-65.20
80.00	.00	-999.99	9.53	9.53	.00000	90.00	LINEAR	0.00000E-01	.00	2.40690E+00	-62.83
75.00	.00	-999.99	9.25	9.25	.00000	90.00	LINEAR	0.00000E-01	.00	2.33094E+00	-58.96
70.00	.00	-999.99	8.86	8.86	.00000	90.00	LINEAR	0.00000E-01	.00	2.22889E+00	-53.74
65.00	.00	-999.99	8.37	8.37	.00000	90.00	LINEAR	0.00000E-01	.00	2.10617E+00	-47.30
60.00	.00	-999.99	7.79	7.79	.00000	90.00	LINEAR	0.00000E-01	.00	1.97024E+00	-39.77
55.00	.00	-999.99	7.15	7.15	.00000	90.00	LINEAR	0.00000E-01	.00	1.82917E+00	-31.17
50.00	.00	-999.99	6.45	6.45	.00000	90.00	LINEAR	0.00000E-01	.00	1.68849E+00	-21.34
45.00	.00	-999.99	5.70	5.70	.00000	90.00	LINEAR	0.00000E-01	.00	1.54747E+00	-9.91
40.00	.00	-999.99	4.81	4.81	.00000	90.00	LINEAR	0.00000E-01	.00	1.39759E+00	3.57
35.00	.00	-999.99	3.67	3.67	.00000	90.00	LINEAR	0.00000E-01	.00	1.22601E+00	19.48
30.00	.00	-999.99	2.10	2.10	.00000	90.00	LINEAR	0.00000E-01	.00	1.02313E+00	38.02
25.00	.00	-999.99	-.14	-.14	.00000	90.00	LINEAR	0.00000E-01	.00	7.90314E-01	59.26
20.00	.00	-999.99	-3.40	-3.40	.00000	90.00	LINEAR	0.00000E-01	.00	5.43333E-01	83.42
15.00	.00	-999.99	-8.27	-8.27	.00000	90.00	LINEAR	0.00000E-01	.00	3.10023E-01	111.77
10.00	.00	-999.99	-16.15	-16.15	.00000	90.00	LINEAR	0.00000E-01	.00	1.25194E-01	152.57
5.00	.00	-999.99	-23.15	-23.15	.00000	90.00	LINEAR	0.00000E-01	.00	5.58629E-02	-103.82
.00	.00	-999.99	-19.63	-19.63	.00000	90.00	LINEAR	0.00000E-01	.00	8.37855E-02	-41.89
-5.00	.00	-999.99	-20.66	-20.66	.00000	90.00	LINEAR	0.00000E-01	.00	7.44409E-02	-24.87
-10.00	.00	-999.99	-22.14	-22.14	.00000	90.00	LINEAR	0.00000E-01	.00	6.27578E-02	-47.83
-15.00	.00	-999.99	-17.70	-17.70	.00000	90.00	LINEAR	0.00000E-01	.00	1.04649E-01	-62.63
-20.00	.00	-999.99	-14.43	-14.43	.00000	90.00	LINEAR	0.00000E-01	.00	1.52508E-01	-50.23
-25.00	.00	-999.99	-13.31	-13.31	.00000	90.00	LINEAR	0.00000E-01	.00	1.73568E-01	-30.90
-30.00	.00	-999.99	-13.96	-13.96	.00000	90.00	LINEAR	0.00000E-01	.00	1.61079E-01	-10.69
-35.00	.00	-999.99	-16.41	-16.41	.00000	90.00	LINEAR	0.00000E-01	.00	1.21488E-01	7.49
-40.00	.00	-999.99	-21.41	-21.41	.00000	90.00	LINEAR	0.00000E-01	.00	6.83240E-02	18.31
-45.00	.00	-999.99	-29.95	-29.95	.00000	90.00	LINEAR	0.00000E-01	.00	2.55614E-02	-16.52
-50.00	.00	-999.99	-24.33	-24.33	.00000	90.00	LINEAR	0.00000E-01	.00	4.87792E-02	-74.32
-55.00	.00	-999.99	-19.91	-19.91	.00000	90.00	LINEAR	0.00000E-01	.00	8.11455E-02	-72.25
-60.00	.00	-999.99	-17.99	-17.99	.00000	90.00	LINEAR	0.00000E-01	.00	1.01234E-01	-63.59
-65.00	.00	-999.99	-17.28	-17.28	.00000	90.00	LINEAR	0.00000E-01	.00	1.09817E-01	-55.16
-70.00	.00	-999.99	-17.24	-17.24	.00000	90.00	LINEAR	0.00000E-01	.00	1.10371E-01	-48.42
-75.00	.00	-999.99	-17.53	-17.53	.00000	90.00	LINEAR	0.00000E-01	.00	1.06719E-01	-43.73
-80.00	.00	-999.99	-17.92	-17.92	.00000	90.00	LINEAR	0.00000E-01	.00	1.02039E-01	-40.94
-85.00	.00	-999.99	-18.23	-18.23	.00000	90.00	LINEAR	0.00000E-01	.00	9.84805E-02	-39.60
-90.00	.00	-999.99	-18.35	-18.35	.00000	90.00	LINEAR	0.00000E-01	.00	9.71799E-02	-39.22

- - - NORMALIZED GAIN - - -

MAJOR AXIS GAIN
 NORMALIZATION FACTOR = 9.75 DB

- - ANGLES' - -			- - ANGLES' - -			- - ANGLES' - -		
THETA	PHI	GAIN	THETA	PHI	GAIN	THETA	PHI	GAIN
DEGREES	DEGREES	DB	DEGREES	DEGREES	DB	DEGREES	DEGREES	DB
90.00	.00	.00	25.00	.00	-9.90	-35.00	.00	-26.16
85.00	.00	-.06	20.00	.00	-13.15	-40.00	.00	-31.16
80.00	.00	-.22	15.00	.00	-18.02	-45.00	.00	-39.70
75.00	.00	-.50	10.00	.00	-25.90	-50.00	.00	-34.09
70.00	.00	-.89	5.00	.00	-32.91	-55.00	.00	-29.67
65.00	.00	-1.38	.00	.00	-29.39	-60.00	.00	-27.74
60.00	.00	-1.96	-5.00	.00	-30.41	-65.00	.00	-27.04
55.00	.00	-2.61	-10.00	.00	-31.90	-70.00	.00	-26.99
50.00	.00	-3.30	-15.00	.00	-27.46	-75.00	.00	-27.29
45.00	.00	-4.06	-20.00	.00	-24.19	-80.00	.00	-27.68
40.00	.00	-4.94	-25.00	.00	-23.06	-85.00	.00	-27.98
35.00	.00	-6.08	-30.00	.00	-23.71	-90.00	.00	-28.10
30.00	.00	-7.65						

```
***** DATA CARD NO. 15  EN  0    0    0    0    0  0.00000E-01  0.00000E-01  0.00000E-01  0.00000E-01  0.00000E-01  0.00000E-01
RUN TIME =      .000
```

Example 6

The geometry data for the cylinder with attached wires was discussed in section III-2. The wire on the end of the cylinder is excited first and a radiation pattern is computed. The CP card requests the coupling between the base segments of the two wires. Hence after the second wire has been excited, the table "ISOLATION DATA" is printed. The coupling printed is the maximum that would occur when the source and load are simultaneously matched to there antennas. The table includes the matched load impedance for the second segment and the corresponding input impedance at the firs segment. The source impedance would be the conjugate of this input impedance for maximum coupling.

(See **Figure 12.**)

Input:

```

CECYLINDER WITH ATTACHED WIRES
SP 0 0 10 0 7.3333 0. 0. 38.4
SP 0 0 10 0 0. 0. 0. 38.4
SP 0 0 10 0 -7.3333 0. 0. 38.4
GM 0 1 0. 0. 30.
SP 0 0 6.89 0. 11. 90. 0. 44.88
SP 0 0 6.89 0. -11. -90. 0. 44.88
GR 0 6
SP 0 0 0. 0. 11. 90. 0. 44.89
SP 0 0 0. 0. -11. -90. 0. 44.89
GW 1 4 0. 0. 11. 0. 0. 23. .1
GW 2 5 10. 0. 0. 27.6 0. 0. .2
GS,0,0,.01
GE
FR,0,1,0,0,465.84
CP 1 1 2 1
EX 0 1 1 1.
RP 0 73 1 1000 0. 0. 5. 0.
EX 0 2 1 0 1.
XQ
EN
    
```

Output:

1

```

*****
NUMERICAL ELECTROMAGNETICS CODE
*****
    
```

- - - - COMMENTS - - - -

CYLINDER WITH ATTACHED WIRES

- - - STRUCTURE SPECIFICATION - - -

```

COORDINATES MUST BE INPUT IN
METERS OR BE SCALED TO METERS
BEFORE STRUCTURE INPUT IS ENDED
    
```

WIRE

NO. OF FIRST LAST TAG

NO.	X1	Y1	Z1	X2	Y2	Z2	RADIUS	SEG.	SEG.	SEG.	NO.
1P	10.00000	.00000	7.33330	.00000	.00000	38.40000					
2P	10.00000	.00000	.00000	.00000	.00000	38.40000					
3P	10.00000	.00000	-7.33330	.00000	.00000	38.40000					
THE STRUCTURE HAS BEEN MOVED, MOVE DATA CARD IS -/6X 0 1 .00000 .00000 30.00000 .00000 .00000 .00000 .00000											
7P	6.89000	.00000	11.00000	90.00000	.00000	44.88000					
8P	6.89000	.00000	-11.00000	-90.00000	.00000	44.88000					
STRUCTURE ROTATED ABOUT Z-AXIS 6 TIMES. LABELS INCREMENTED BY 0											
49P	.00000	.00000	11.00000	90.00000	.00000	44.89000					
50P	.00000	.00000	-11.00000	-90.00000	.00000	44.89000					
1	.00000	.00000	11.00000	.00000	.00000	23.00000	.10000	4	1	4	1
2	10.00000	.00000	.00000	27.60000	.00000	.00000	.20000	5	5	9	2
STRUCTURE SCALED BY FACTOR .010000											

TOTAL SEGMENTS USED= 9 NO. SEG. IN A SYMMETRIC CELL= 9 SYMMETRY FLAG= 0
 TOTAL PATCHES USED= 56 NO. PATCHES IN A SYMMETRIC CELL= 56

- MULTIPLE WIRE JUNCTIONS -
 JUNCTION SEGMENTS (- FOR END 1, + FOR END 2)
 NONE

- - - - SEGMENTATION DATA - - - -

COORDINATES IN METERS

I+ AND I- INDICATE THE SEGMENTS BEFORE AND AFTER I

SEG. NO.	COORDINATES OF SEG. CENTER			SEG. LENGTH	ORIENTATION ANGLES		WIRE RADIUS	CONNECTION DATA			TAG NO.
	X	Y	Z		ALPHA	BETA		I-	I	I+	
1	.00000	.00000	.12500	.03000	90.00000	.00000	.00100	10052	1	2	1
2	.00000	.00000	.15500	.03000	90.00000	.00000	.00100	1	2	3	1
3	.00000	.00000	.18500	.03000	90.00000	.00000	.00100	2	3	4	1
4	.00000	.00000	.21500	.03000	90.00000	.00000	.00100	3	4	0	1
5	.11760	.00000	.00000	.03520	.00000	.00000	.00200	10002	5	6	2
6	.15280	.00000	.00000	.03520	.00000	.00000	.00200	5	6	7	2
7	.18800	.00000	.00000	.03520	.00000	.00000	.00200	6	7	8	2
8	.22320	.00000	.00000	.03520	.00000	.00000	.00200	7	8	9	2
9	.25840	.00000	.00000	.03520	.00000	.00000	.00200	8	9	0	2

- - - SURFACE PATCH DATA - - -

COORDINATES IN METERS

PATCH NO.	COORD. OF PATCH CENTER			UNIT NORMAL VECTOR			PATCH AREA	COMPONENTS OF UNIT TANGENT VECTORS					
	X	Y	Z	X	Y	Z		X1	Y1	Z1	X2	Y2	Z2
1	.10000	.00000	.07333	1.0000	.0000	-.0000	.00384	.0000	1.0000	.0000	.0000	-.0000	1.0000
2	.10000	.01549	.01549	1.0000	.0000	-.0000	.00096	.0000	1.0000	.0000	.0000	-.0000	1.0000
3	.10000	-.01549	.01549	1.0000	.0000	-.0000	.00096	.0000	1.0000	.0000	.0000	-.0000	1.0000
4	.10000	-.01549	-.01549	1.0000	.0000	-.0000	.00096	.0000	1.0000	.0000	.0000	-.0000	1.0000
5	.10000	.01549	-.01549	1.0000	.0000	-.0000	.00096	.0000	1.0000	.0000	.0000	-.0000	1.0000
6	.10000	.00000	-.07333	1.0000	.0000	-.0000	.00384	.0000	1.0000	.0000	.0000	-.0000	1.0000
7	.08660	.05000	.07333	.8660	.5000	-.0000	.00384	-.5000	.8660	.0000	.0000	.0000	1.0000
8	.08660	.05000	.00000	.8660	.5000	-.0000	.00384	-.5000	.8660	.0000	.0000	.0000	1.0000
9	.08660	.05000	-.07333	.8660	.5000	-.0000	.00384	-.5000	.8660	.0000	.0000	.0000	1.0000
10	.06890	.00000	.11000	-.0000	.0000	1.0000	.00449	1.0000	.0000	.0000	.0000	1.0000	-.0000
11	.06890	.00000	-.11000	.0000	.0000	-1.0000	.00449	1.0000	.0000	.0000	.0000	-1.0000	-.0000
12	.05000	.08660	.07333	.5000	.8660	-.0000	.00384	-.8660	.5000	.0000	.0000	.0000	1.0000
13	.05000	.08660	.00000	.5000	.8660	-.0000	.00384	-.8660	.5000	.0000	.0000	.0000	1.0000
14	.05000	.08660	-.07333	.5000	.8660	-.0000	.00384	-.8660	.5000	.0000	.0000	.0000	1.0000
15	0.00000	.10000	.07333	0.0000	1.0000	.0000	.00384	-1.0000	0.0000	.0000	.0000	.0000	1.0000
16	0.00000	.10000	.00000	0.0000	1.0000	.0000	.00384	-1.0000	0.0000	.0000	.0000	.0000	1.0000
17	0.00000	.10000	-.07333	0.0000	1.0000	.0000	.00384	-1.0000	0.0000	.0000	.0000	.0000	1.0000
18	.03445	.05967	.11000	-.0000	.0000	1.0000	.00449	.5000	.8660	.0000	-.8660	.5000	-.0000
19	.03445	.05967	-.11000	.0000	.0000	-1.0000	.00449	.5000	.8660	.0000	.8660	-.5000	-.0000
20	-.05000	.08660	.07333	-.5000	.8660	.0000	.00384	-.8660	-.5000	.0000	.0000	.0000	1.0000
21	-.05000	.08660	.00000	-.5000	.8660	.0000	.00384	-.8660	-.5000	.0000	.0000	.0000	1.0000
22	-.05000	.08660	-.07333	-.5000	.8660	.0000	.00384	-.8660	-.5000	.0000	.0000	.0000	1.0000
23	-.08660	.05000	.07333	-.8660	.5000	.0000	.00384	-.5000	-.8660	.0000	.0000	.0000	1.0000
24	-.08660	.05000	.00000	-.8660	.5000	.0000	.00384	-.5000	-.8660	.0000	.0000	.0000	1.0000
25	-.08660	.05000	-.07333	-.8660	.5000	.0000	.00384	-.5000	-.8660	.0000	.0000	.0000	1.0000
26	-.03445	.05967	.11000	.0000	-.0000	1.0000	.00449	-.5000	.8660	.0000	-.8660	-.5000	-.0000
27	-.03445	.05967	-.11000	-.0000	.0000	-1.0000	.00449	-.5000	.8660	.0000	.8660	.5000	-.0000
28	-1.00000	0.00000	.07333	-1.0000	0.0000	.0000	.00384	0.0000	-1.0000	.0000	.0000	.0000	1.0000
29	-1.00000	0.00000	.00000	-1.0000	0.0000	.0000	.00384	0.0000	-1.0000	.0000	.0000	.0000	1.0000
30	-1.00000	0.00000	-.07333	-1.0000	0.0000	.0000	.00384	0.0000	-1.0000	.0000	.0000	.0000	1.0000

31	-.08660	-.05000	.07333	-.8660	-.5000	.0000	.00384	.5000	-.8660	.0000	.0000	.0000	1.0000
32	-.08660	-.05000	.00000	-.8660	-.5000	.0000	.00384	.5000	-.8660	.0000	.0000	.0000	1.0000
33	-.08660	-.05000	-.07333	-.8660	-.5000	.0000	.00384	.5000	-.8660	.0000	.0000	.0000	1.0000
34	-.06890	0.00000	.11000	.0000	.0000	1.0000	.00449	-1.0000	0.0000	.0000	0.0000	-1.0000	-.0000
35	-.06890	0.00000	-.11000	.0000	-.0000	-1.0000	.00449	-1.0000	0.0000	.0000	0.0000	1.0000	-.0000
36	-.05000	-.08660	.07333	-.5000	-.8660	.0000	.00384	.8660	-.5000	.0000	.0000	.0000	1.0000
37	-.05000	-.08660	.00000	-.5000	-.8660	.0000	.00384	.8660	-.5000	.0000	.0000	.0000	1.0000
38	-.05000	-.08660	-.07333	-.5000	-.8660	.0000	.00384	.8660	-.5000	.0000	.0000	.0000	1.0000
39	0.00000	-.10000	.07333	0.0000	-1.0000	.0000	.00384	1.0000	0.0000	.0000	.0000	.0000	1.0000
40	0.00000	-.10000	.00000	0.0000	-1.0000	.0000	.00384	1.0000	0.0000	.0000	.0000	.0000	1.0000
41	0.00000	-.10000	-.07333	0.0000	-1.0000	.0000	.00384	1.0000	0.0000	.0000	.0000	.0000	1.0000
42	-.03445	-.05967	.11000	.0000	.0000	1.0000	.00449	-.5000	-.8660	.0000	.8660	-.5000	-.0000
43	-.03445	-.05967	-.11000	.0000	-.0000	-1.0000	.00449	-.5000	-.8660	.0000	-.8660	.5000	-.0000
44	.05000	-.08660	.07333	.5000	-.8660	.0000	.00384	.8660	.5000	.0000	.0000	.0000	1.0000
45	.05000	-.08660	.00000	.5000	-.8660	.0000	.00384	.8660	.5000	.0000	.0000	.0000	1.0000
46	.05000	-.08660	-.07333	.5000	-.8660	.0000	.00384	.8660	.5000	.0000	.0000	.0000	1.0000
47	.08660	-.05000	.07333	.8660	-.5000	.0000	.00384	.5000	.8660	.0000	.0000	.0000	1.0000
48	.08660	-.05000	.00000	.8660	-.5000	.0000	.00384	.5000	.8660	.0000	.0000	.0000	1.0000
49	.08660	-.05000	-.07333	.8660	-.5000	.0000	.00384	.5000	.8660	.0000	.0000	.0000	1.0000
50	.03445	-.05967	.11000	.0000	.0000	1.0000	.00449	.5000	-.8660	.0000	.8660	.5000	-.0000
51	.03445	-.05967	-.11000	.0000	.0000	-1.0000	.00449	.5000	-.8660	.0000	-.8660	-.5000	-.0000
52	.01675	.01675	.11000	-.0000	.0000	1.0000	.00112	1.0000	.0000	.0000	.0000	1.0000	-.0000
53	-.01675	.01675	.11000	-.0000	.0000	1.0000	.00112	1.0000	.0000	.0000	.0000	1.0000	-.0000
54	-.01675	-.01675	.11000	-.0000	.0000	1.0000	.00112	1.0000	.0000	.0000	.0000	1.0000	-.0000
55	.01675	-.01675	.11000	-.0000	.0000	1.0000	.00112	1.0000	.0000	.0000	.0000	1.0000	-.0000
56	.00000	.00000	-.11000	.0000	.0000	-1.0000	.00449	1.0000	.0000	.0000	.0000	-1.0000	-.0000

```

***** DATA CARD NO. 1 FR 0 1 0 0 4.65840E+02 0.00000E-01 0.00000E-01 0.00000E-01 0.00000E-01 0.00000E-01
***** DATA CARD NO. 2 CP 1 1 2 1 0.00000E-01 0.00000E-01 0.00000E-01 0.00000E-01 0.00000E-01 0.00000E-01
***** DATA CARD NO. 3 EX 0 1 1 1 0.00000E-01 0.00000E-01 0.00000E-01 0.00000E-01 0.00000E-01 0.00000E-01
***** DATA CARD NO. 4 RP 0 73 1 1000 0.00000E-01 0.00000E-01 5.00000E+00 0.00000E-01 0.00000E-01 0.00000E-01
    
```

----- FREQUENCY -----

FREQUENCY= 4.6584E+02 MHZ
 WAVELENGTH= 6.4357E-01 METERS

APPROXIMATE INTEGRATION EMPLOYED FOR SEGMENTS MORE THAN 1.000 WAVELENGTHS APART

----- STRUCTURE IMPEDANCE LOADING -----

THIS STRUCTURE IS NOT LOADED

----- ANTENNA ENVIRONMENT -----

FREE SPACE

----- MATRIX TIMING -----

FILL= .000 SEC., FACTOR= .000 SEC.

----- ANTENNA INPUT PARAMETERS -----

TAG NO.	SEG. NO.	VOLTAGE (VOLTS)		CURRENT (AMPS)		IMPEDANCE (OHMS)		ADMITTANCE (MHOS)		POWER (WATTS)
		REAL	IMAG.	REAL	IMAG.	REAL	IMAG.	REAL	IMAG.	
1	1	1.00000E+00	0.00000E-01	1.25132E-03	8.29226E-03	1.77928E+01	-1.17909E+02	1.25132E-03	8.29226E-03	6.25660E-04

----- CURRENTS AND LOCATION -----

DISTANCES IN WAVELENGTHS

SEG. TAG COORD. OF SEG. CENTER SEG. ----- CURRENT (AMPS) -----

NO.	NO.	X	Y	Z	LENGTH	REAL	IMAG.	MAG.	PHASE
1	1	.0000	.0000	.1942	.04662	1.2513E-03	8.2923E-03	8.3861E-03	81.419
2	1	.0000	.0000	.2408	.04662	1.0975E-03	6.5800E-03	6.6709E-03	80.531
3	1	.0000	.0000	.2875	.04662	7.9167E-04	4.3758E-03	4.4468E-03	79.745
4	1	.0000	.0000	.3341	.04662	3.3076E-04	1.7250E-03	1.7564E-03	79.146
5	2	.1827	.0000	.0000	.05470	-7.5903E-04	1.5534E-03	1.7289E-03	116.041
6	2	.2374	.0000	.0000	.05470	-7.0144E-04	1.4307E-03	1.5934E-03	116.118
7	2	.2921	.0000	.0000	.05470	-5.8434E-04	1.1901E-03	1.3258E-03	116.152
8	2	.3468	.0000	.0000	.05470	-4.0799E-04	8.3173E-04	9.2641E-04	116.130
9	2	.4015	.0000	.0000	.05470	-1.6997E-04	3.4747E-04	3.8681E-04	116.067

- - - SURFACE PATCH CURRENTS - - -

DISTANCE IN WAVELENGTHS
CURRENT IN AMPS/METER

- - SURFACE COMPONENTS - -							- - - RECTANGULAR COMPONENTS - - -					
PATCH CENTER			TANGENT VECTOR 1	TANGENT VECTOR 2	REAL		Y		Z			
X	Y	Z	MAG.	PHASE	MAG.	PHASE	REAL	IMAG.	REAL	IMAG.	REAL	IMAG.
1												
.155	.000	.114	8.2306E-10	-137.07	7.1961E-03	-35.22	0.00E-01	-0.00E-01	-6.03E-10	-5.61E-10	5.88E-03	-4.15E-03
2												
.155	.024	.024	9.0011E-03	-65.46	1.4220E-02	-51.34	0.00E-01	-0.00E-01	3.74E-03	-8.19E-03	8.88E-03	-1.11E-02
3												
.155	-.024	.024	9.0011E-03	114.54	1.4220E-02	-51.34	0.00E-01	0.00E-01	-3.74E-03	8.19E-03	8.88E-03	-1.11E-02
4												
.155	-.024	-.024	9.0080E-03	114.49	5.0962E-03	84.31	0.00E-01	0.00E-01	-3.73E-03	8.20E-03	5.06E-04	5.07E-03
5												
.155	.024	-.024	9.0079E-03	-65.51	5.0962E-03	84.31	0.00E-01	0.00E-01	3.73E-03	-8.20E-03	5.06E-04	5.07E-03
6												
.155	.000	-.114	6.8882E-10	118.13	1.5973E-03	12.53	0.00E-01	0.00E-01	-3.25E-10	6.07E-10	1.56E-03	3.46E-04
7												
.135	.078	.114	1.8792E-03	-94.87	5.5428E-03	-11.30	7.97E-05	9.36E-04	-1.38E-04	-1.62E-03	5.44E-03	-1.09E-03
8												
.135	.078	.000	3.9148E-03	-75.49	5.3139E-03	-33.00	-4.90E-04	1.89E-03	8.49E-04	-3.28E-03	4.46E-03	-2.89E-03
9												
.135	.078	-.114	1.8133E-03	-94.60	2.9184E-03	-33.42	7.28E-05	9.04E-04	-1.26E-04	-1.57E-03	2.44E-03	-1.61E-03
10												
.107	.000	.171	1.3691E-02	-104.81	1.1337E-09	-154.91	-3.50E-03	-1.32E-02	-1.03E-09	-4.81E-10	0.00E-01	0.00E-01
11												
.107	.000	-.171	1.5187E-03	-10.62	1.0574E-09	-70.17	1.49E-03	-2.80E-04	-3.59E-10	9.95E-10	0.00E-01	0.00E-01
12												
.078	.135	.114	1.6705E-03	-129.81	4.7414E-03	-8.86	9.26E-04	1.11E-03	-5.35E-04	-6.42E-04	4.68E-03	-7.30E-04
13												
.078	.135	.000	1.6294E-03	-112.84	5.3699E-03	-33.12	5.48E-04	1.30E-03	-3.16E-04	-7.51E-04	4.50E-03	-2.93E-03
14												
.078	.135	-.114	1.7226E-03	-128.58	4.1506E-03	-48.62	9.30E-04	1.17E-03	-5.37E-04	-6.73E-04	2.74E-03	-3.11E-03
15												
0.000	.155	.114	1.4450E-03	-160.34	5.3232E-03	11.87	1.36E-03	4.86E-04	4.06E-11	1.45E-11	5.21E-03	1.09E-03
16												
0.000	.155	.000	1.2074E-03	-155.49	5.3690E-03	-32.95	1.10E-03	5.01E-04	3.27E-11	1.49E-11	4.51E-03	-2.92E-03
17												
0.000	.155	-.114	1.4416E-03	-160.26	4.6031E-03	-54.61	1.36E-03	4.87E-04	4.04E-11	1.45E-11	2.67E-03	-3.75E-03
18												
.054	.093	.171	1.4845E-02	-105.23	1.6076E-03	-145.64	-8.01E-04	-6.38E-03	-4.04E-03	-1.29E-02	0.00E-01	0.00E-01
19												
.054	.093	-.171	1.7548E-03	-50.91	1.6063E-03	35.02	1.69E-03	1.17E-04	3.00E-04	-1.64E-03	0.00E-01	-0.00E-01
20												
-.078	.135	.114	1.3169E-03	-178.68	5.0409E-03	-2.54	1.14E-03	2.63E-05	6.58E-04	1.52E-05	5.04E-03	-2.24E-04
21												
-.078	.135	.000	9.9495E-04	178.63	5.3744E-03	-33.13	8.61E-04	-2.05E-05	4.97E-04	-1.19E-05	4.50E-03	-2.94E-03
22												
-.078	.135	-.114	1.3019E-03	178.62	4.3371E-03	-56.62	1.13E-03	-2.72E-05	6.51E-04	-1.57E-05	2.39E-03	-3.62E-03
23												
-.135	.078	.114	7.0536E-04	161.19	5.7472E-03	9.56	3.34E-04	-1.14E-04	5.78E-04	-1.97E-04	5.67E-03	9.54E-04
24												
-.135	.078	.000	5.8000E-04	165.30	5.3716E-03	-33.03	2.81E-04	-7.36E-05	4.86E-04	-1.27E-04	4.50E-03	-2.93E-03
25												
-.135	.078	-.114	6.9540E-04	166.60	4.2602E-03	-58.97	3.38E-04	-8.06E-05	5.86E-04	-1.40E-04	2.20E-03	-3.65E-03
26												
-.054	.093	.171	1.5570E-02	-109.02	1.4143E-03	-176.69	3.76E-03	7.43E-03	-3.69E-03	-1.27E-02	0.00E-01	0.00E-01
27												
-.054	.093	-.171	1.7609E-03	-92.00	1.4055E-03	2.99	1.25E-03	9.43E-04	6.48E-04	-1.49E-03	-0.00E-01	-0.00E-01
28												
-.155	0.000	.114	1.0996E-09	43.34	5.2708E-03	-3.82	4.77E-17	4.50E-17	-8.00E-10	-7.55E-10	5.26E-03	-3.51E-04
29												
-.155	0.000	.000	6.9614E-10	-76.06	5.3701E-03	-33.05	1.00E-17	-4.03E-17	-1.68E-10	6.76E-10	4.50E-03	-2.93E-03
30												
-.155	0.000	-.114	1.0166E-09	-57.35	4.0753E-03	-57.88	3.27E-17	-5.10E-17	-5.48E-10	8.56E-10	2.17E-03	-3.45E-03
31												
-.135	-.078	.114	7.0536E-04	-18.81	5.7472E-03	9.56	3.34E-04	-1.14E-04	-5.78E-04	1.97E-04	5.67E-03	9.54E-04

32	-.135	-.078	.000	5.8000E-04	-14.70	5.3716E-03	-33.03	2.81E-04	-7.36E-05	-4.86E-04	1.27E-04	4.50E-03	-2.93E-03
33	-.135	-.078	-.114	6.9541E-04	-13.40	4.2602E-03	-58.97	3.38E-04	-8.06E-05	-5.86E-04	1.40E-04	2.20E-03	-3.65E-03
34	-.107	0.000	.171	1.5557E-02	-111.31	1.7509E-09	55.73	5.65E-03	1.45E-02	-6.49E-10	-5.83E-10	-0.00E-01	-0.00E-01
35	-.107	0.000	-.171	1.6720E-03	-112.54	1.4723E-09	138.28	6.41E-04	1.54E-03	-1.06E-09	1.07E-09	0.00E-01	-0.00E-01
36	-.078	-.135	.114	1.3169E-03	1.32	5.0409E-03	-2.54	1.14E-03	2.63E-05	-6.58E-04	-1.52E-05	5.04E-03	-2.24E-04
37	-.078	-.135	.000	9.9495E-04	-1.37	5.3744E-03	-33.13	8.61E-04	-2.05E-05	-4.97E-04	1.19E-05	4.50E-03	-2.94E-03
38	-.078	-.135	-.114	1.3019E-03	-1.38	4.3371E-03	-56.62	1.13E-03	-2.72E-05	-6.51E-04	1.57E-05	2.39E-03	-3.62E-03
39	0.000	-.155	.114	1.4450E-03	19.66	5.3232E-03	11.87	1.36E-03	4.86E-04	1.62E-10	5.79E-11	5.21E-03	1.09E-03
40	0.000	-.155	.000	1.2074E-03	24.51	5.3690E-03	-32.95	1.10E-03	5.01E-04	1.31E-10	5.97E-11	4.51E-03	-2.92E-03
41	0.000	-.155	-.114	1.4416E-03	19.74	4.6031E-03	-54.61	1.36E-03	4.87E-04	1.62E-10	5.80E-11	2.67E-03	-3.75E-03
42	-.054	-.093	.171	1.5569E-02	-109.02	1.4143E-03	3.31	3.76E-03	7.43E-03	3.69E-03	1.27E-02	-0.00E-01	-0.00E-01
43	-.054	-.093	-.171	1.7609E-03	-92.00	1.4055E-03	-177.01	1.25E-03	9.43E-04	-6.48E-04	1.49E-03	0.00E-01	0.00E-01
44	.078	-.135	.114	1.6705E-03	50.19	4.7414E-03	-8.86	9.26E-04	1.11E-03	5.35E-04	6.42E-04	4.68E-03	-7.30E-04
45	.078	-.135	.000	1.6294E-03	67.16	5.3699E-03	-33.12	5.48E-04	1.30E-03	3.16E-04	7.51E-04	4.50E-03	-2.93E-03
46	.078	-.135	-.114	1.7226E-03	51.42	4.1506E-03	-48.62	9.30E-04	1.17E-03	5.37E-04	6.73E-04	2.74E-03	-3.11E-03
47	.135	-.078	.114	1.8792E-03	85.13	5.5428E-03	-11.30	7.97E-05	9.36E-04	1.38E-04	1.62E-03	5.44E-03	-1.09E-03
48	.135	-.078	.000	3.9148E-03	104.51	5.3139E-03	-33.00	-4.90E-04	1.89E-03	-8.49E-04	3.28E-03	4.46E-03	-2.89E-03
49	.135	-.078	-.114	1.8133E-03	85.40	2.9184E-03	-33.42	7.28E-05	9.04E-04	1.26E-04	1.57E-03	2.44E-03	-1.61E-03
50	.054	-.093	.171	1.4845E-02	-105.23	1.6076E-03	34.36	-8.01E-04	-6.38E-03	4.04E-03	1.29E-02	-0.00E-01	-0.00E-01
51	.054	-.093	-.171	1.7548E-03	-50.91	1.6063E-03	-144.98	1.69E-03	1.17E-04	-3.00E-04	1.64E-03	0.00E-01	0.00E-01
52	.026	.026	.171	3.7707E-02	-97.61	3.8523E-02	-99.40	-4.99E-03	-3.74E-02	-6.29E-03	-3.80E-02	0.00E-01	0.00E-01
53	-.026	.026	.171	3.8971E-02	78.78	3.8496E-02	-99.34	7.58E-03	3.82E-02	-6.25E-03	-3.80E-02	0.00E-01	0.00E-01
54	-.026	-.026	.171	3.8971E-02	78.78	3.8496E-02	80.66	7.58E-03	3.82E-02	6.25E-03	3.80E-02	0.00E-01	0.00E-01
55	.026	-.026	.171	3.7707E-02	-97.61	3.8523E-02	80.60	-4.99E-03	-3.74E-02	6.29E-03	3.80E-02	-0.00E-01	-0.00E-01
56	.000	.000	-.171	1.3523E-03	18.00	1.2976E-09	-58.81	1.29E-03	4.18E-04	-6.72E-10	1.11E-09	0.00E-01	0.00E-01

- - - POWER BUDGET - - -

INPUT POWER = 6.2566E-04 WATTS
 RADIATED POWER= 6.2566E-04 WATTS
 STRUCTURE LOSS= 0.0000E-01 WATTS
 NETWORK LOSS = 0.0000E-01 WATTS
 EFFICIENCY = 100.00 PERCENT

- - - RADIATION PATTERNS - - -

- - ANGLES - -		- POWER GAINS -			- - - POLARIZATION - - -			- - - E(THETA) - - -		- - - E(PHI) - - -	
THETA	PHI	VERT.	HOR.	TOTAL	AXIAL	TILT	SENSE	MAGNITUDE	PHASE	MAGNITUDE	PHASE
DEGREES	DEGREES	DB	DB	DB	RATIO	DEG.		VOLTS/M	DEGREES	VOLTS/M	DEGREES
.00	.00	-8.11	-145.92	-8.11	0.00000	0.00	LINEAR	7.61669E-02	-2.26	9.79259E-09	-81.36
5.00	.00	-8.34	-149.37	-8.34	0.00000	0.00	LINEAR	7.41602E-02	-2.08	6.58361E-09	-69.02
10.00	.00	-8.85	-145.42	-8.85	0.00000	0.00	LINEAR	6.99499E-02	-2.76	1.03806E-08	-111.51
15.00	.00	-9.70	-147.83	-9.70	0.00000	0.00	LINEAR	6.33760E-02	-4.63	7.86732E-09	-91.91
20.00	.00	-11.01	-148.43	-11.01	0.00000	0.00	LINEAR	5.44956E-02	-8.24	7.33620E-09	-174.02
25.00	.00	-12.94	-144.61	-12.94	0.00000	0.00	LINEAR	4.36416E-02	-14.78	1.13919E-08	-113.95
30.00	.00	-15.74	-144.06	-15.74	0.00000	0.00	LINEAR	3.16466E-02	-27.33	1.21418E-08	-121.58
35.00	.00	-19.30	-145.83	-19.30	0.00000	0.00	LINEAR	2.09977E-02	-55.34	9.90304E-09	-129.72
40.00	.00	-19.97	-150.11	-19.97	0.00000	0.00	LINEAR	1.94288E-02	-107.78	6.04458E-09	-138.61
45.00	.00	-16.08	-161.08	-16.08	0.00000	0.00	LINEAR	3.04205E-02	-145.28	1.70958E-09	125.00
50.00	.00	-12.40	-160.36	-12.40	0.00000	0.00	LINEAR	4.64488E-02	-163.87	1.85801E-09	-172.34
55.00	.00	-9.60	-150.67	-9.60	0.00000	0.00	LINEAR	6.41559E-02	-175.93	5.67075E-09	81.70
60.00	.00	-7.40	-155.62	-7.40	0.00000	0.00	LINEAR	8.26330E-02	174.32	3.20721E-09	75.14
65.00	.00	-5.61	-144.42	-5.61	0.00000	0.00	LINEAR	1.01577E-01	165.52	1.16394E-08	147.06
70.00	.00	-4.10	-144.86	-4.10	0.00000	0.00	LINEAR	1.20850E-01	157.18	1.10625E-08	124.46
75.00	.00	-2.80	-143.11	-2.80	0.00000	0.00	LINEAR	1.40312E-01	149.15	1.35334E-08	122.02

80.00	.00	-1.67	-141.35	-1.67	0.00000	0.00	LINEAR	1.59736E-01	141.42	1.65860E-08	115.82
85.00	.00	-.70	-139.77	-.70	0.00000	0.00	LINEAR	1.78758E-01	133.99	1.98840E-08	108.79
90.00	.00	.14	-138.41	.14	0.00000	0.00	LINEAR	1.96870E-01	126.92	2.32483E-08	108.46
95.00	.00	.84	-137.40	.84	0.00000	0.00	LINEAR	2.13447E-01	120.23	2.61185E-08	102.58
100.00	.00	1.41	-137.04	1.41	0.00000	0.00	LINEAR	2.27788E-01	113.95	2.72363E-08	98.49
105.00	.00	1.83	-134.57	1.83	0.00000	0.00	LINEAR	2.39180E-01	108.08	3.61761E-08	120.29
110.00	.00	2.11	-134.36	2.11	0.00000	0.00	LINEAR	2.46958E-01	102.65	3.70790E-08	113.58
115.00	.00	2.24	-133.96	2.24	0.00000	0.00	LINEAR	2.50561E-01	97.66	3.88272E-08	112.65
120.00	.00	2.20	-133.94	2.20	0.00000	0.00	LINEAR	2.49579E-01	93.15	3.89178E-08	104.56
125.00	.00	2.00	-132.55	2.00	0.00000	0.00	LINEAR	2.43788E-01	89.16	4.56769E-08	115.42
130.00	.00	1.61	-132.26	1.61	0.00000	0.00	LINEAR	2.33171E-01	85.74	4.72062E-08	104.46
135.00	.00	1.02	-132.65	1.02	0.00000	0.00	LINEAR	2.17933E-01	82.99	4.51247E-08	96.16
140.00	.00	.21	-131.58	.21	0.00000	0.00	LINEAR	1.98504E-01	81.07	5.10647E-08	89.61
145.00	.00	-.85	-130.91	-.85	0.00000	0.00	LINEAR	1.75552E-01	80.23	5.51472E-08	98.01
150.00	.00	-2.22	-131.89	-2.22	0.00000	0.00	LINEAR	1.50003E-01	80.93	4.92915E-08	100.64
155.00	.00	-3.93	-130.37	-3.93	0.00000	0.00	LINEAR	1.23133E-01	83.98	5.86798E-08	97.69
160.00	.00	-6.02	-130.36	-6.02	0.00000	0.00	LINEAR	9.68259E-02	90.95	5.87511E-08	98.17
165.00	.00	-8.33	-131.25	-8.33	0.00000	0.00	LINEAR	7.42605E-02	104.77	5.30129E-08	94.31
170.00	.00	-10.04	-130.46	-10.04	0.00000	0.00	LINEAR	6.09919E-02	128.42	5.80971E-08	99.67
175.00	.00	-9.83	-130.45	-9.83	0.00000	0.00	LINEAR	6.24516E-02	156.53	5.81702E-08	91.38
180.00	.00	-8.13	-130.43	-8.13	0.00000	0.00	LINEAR	7.59535E-02	177.76	5.82939E-08	93.98
185.00	.00	-6.24	-132.34	-6.24	0.00000	0.00	LINEAR	9.43838E-02	-168.89	4.67661E-08	93.33
190.00	.00	-4.65	-131.57	-4.65	0.00000	0.00	LINEAR	1.13347E-01	-159.93	5.11003E-08	90.55
195.00	.00	-3.40	-131.12	-3.40	0.00000	0.00	LINEAR	1.30926E-01	-152.98	5.38616E-08	93.78
200.00	.00	-2.43	-131.85	-2.43	0.00000	0.00	LINEAR	1.46405E-01	-146.80	4.94915E-08	94.57
205.00	.00	-1.68	-132.69	-1.68	0.00000	0.00	LINEAR	1.59675E-01	-140.77	4.49235E-08	90.45
210.00	.00	-1.08	-133.02	-1.08	0.00000	0.00	LINEAR	1.70952E-01	-134.56	4.32514E-08	93.88
215.00	.00	-.61	-133.78	-.61	0.00000	0.00	LINEAR	1.80612E-01	-128.05	3.96429E-08	92.19
220.00	.00	-.21	-133.12	-.21	0.00000	0.00	LINEAR	1.89044E-01	-121.22	4.27730E-08	99.03
225.00	.00	.13	-134.58	.13	0.00000	0.00	LINEAR	1.96539E-01	-114.15	3.61401E-08	94.18
230.00	.00	.42	-133.59	.42	0.00000	0.00	LINEAR	2.03206E-01	-106.92	4.05276E-08	94.20
235.00	.00	.66	-134.17	.66	0.00000	0.00	LINEAR	2.08951E-01	-99.67	3.79106E-08	95.65
240.00	.00	.85	-134.36	.85	0.00000	0.00	LINEAR	2.13503E-01	-92.48	3.70592E-08	96.96
245.00	.00	.97	-135.55	.97	0.00000	0.00	LINEAR	2.16481E-01	-85.42	3.23151E-08	91.49
250.00	.00	1.01	-135.82	1.01	0.00000	0.00	LINEAR	2.17478E-01	-78.55	3.13543E-08	88.09
255.00	.00	.95	-137.17	.95	0.00000	0.00	LINEAR	2.16147E-01	-71.88	2.68297E-08	89.41
260.00	.00	.80	-138.93	.80	0.00000	0.00	LINEAR	2.12257E-01	-65.41	2.19092E-08	93.60
265.00	.00	.52	-138.14	.52	0.00000	0.00	LINEAR	2.05736E-01	-59.16	2.39974E-08	119.62
270.00	.00	.13	-138.37	.13	0.00000	0.00	LINEAR	1.96690E-01	-53.13	2.33769E-08	90.75
275.00	.00	-.38	-140.37	-.38	0.00000	0.00	LINEAR	1.85395E-01	-47.32	1.85623E-08	107.31
280.00	.00	-1.02	-142.72	-1.02	0.00000	0.00	LINEAR	1.72285E-01	-41.75	1.41596E-08	90.68
285.00	.00	-1.77	-144.43	-1.77	0.00000	0.00	LINEAR	1.57915E-01	-36.46	1.16280E-08	99.32
290.00	.00	-2.64	-145.56	-2.64	0.00000	0.00	LINEAR	1.42926E-01	-31.49	1.02109E-08	121.78
295.00	.00	-3.60	-149.41	-3.60	0.00000	0.00	LINEAR	1.27994E-01	-26.91	6.55236E-09	133.09
300.00	.00	-4.62	-152.39	-4.62	0.00000	0.00	LINEAR	1.13792E-01	-22.79	4.65211E-09	41.79
305.00	.00	-5.66	-145.17	-5.66	0.00000	0.00	LINEAR	1.00935E-01	-19.23	1.06751E-08	175.92
310.00	.00	-6.66	-177.46	-6.66	0.00000	0.00	LINEAR	8.99418E-02	-16.30	2.59574E-10	-107.34
315.00	.00	-7.55	-153.21	-7.55	0.00000	0.00	LINEAR	8.11945E-02	-14.02	4.23319E-09	-66.83
320.00	.00	-8.25	-158.75	-8.25	0.00000	0.00	LINEAR	7.48973E-02	-12.33	2.23579E-09	-93.20
325.00	.00	-8.71	-146.52	-8.71	0.00000	0.00	LINEAR	7.10490E-02	-11.02	9.14371E-09	-102.11
330.00	.00	-8.91	-145.13	-8.91	0.00000	0.00	LINEAR	6.94311E-02	-9.84	1.07239E-08	-105.30
335.00	.00	-8.89	-146.62	-8.89	0.00000	0.00	LINEAR	6.96292E-02	-8.60	9.03758E-09	-120.77
340.00	.00	-8.71	-148.98	-8.71	0.00000	0.00	LINEAR	7.10808E-02	-7.21	6.89128E-09	-61.50
345.00	.00	-8.46	-145.81	-8.46	0.00000	0.00	LINEAR	7.31340E-02	-5.72	9.91779E-09	-76.09
350.00	.00	-8.23	-143.78	-8.23	0.00000	0.00	LINEAR	7.51023E-02	-4.27	1.25291E-08	-79.11
355.00	.00	-8.09	-143.32	-8.09	0.00000	0.00	LINEAR	7.63154E-02	-3.06	1.32168E-08	-87.43
360.00	.00	-8.11	-149.72	-8.11	0.00000	0.00	LINEAR	7.61669E-02	-2.26	6.32676E-09	-76.55

***** DATA CARD NO. 5 EX 0 2 1 0 1.00000E+00 0.00000E-01 0.00000E-01 0.00000E-01 0.00000E-01 0.00000E-01
 ***** DATA CARD NO. 6 XQ 0 0 0 0 0.00000E-01 0.00000E-01 0.00000E-01 0.00000E-01 0.00000E-01 0.00000E-01

- - - ANTENNA INPUT PARAMETERS - - -

TAG NO.	SEG. NO.	VOLTAGE (VOLTS)		CURRENT (AMPS)		IMPEDANCE (OHMS)		ADMITTANCE (MHOS)		POWER (WATTS)
		REAL	IMAG.	REAL	IMAG.	REAL	IMAG.	REAL	IMAG.	
2	5	1.00000E+00	0.00000E-01	1.50257E-02	-6.91341E-03	5.49253E+01	2.52715E+01	1.50257E-02	-6.91341E-03	7.51283E-03

- - - CURRENTS AND LOCATION - - -

DISTANCES IN WAVELENGTHS

SEG. NO.	TAG NO.	COORD. OF SEG. CENTER			SEG. LENGTH	CURRENT (AMPS)			PHASE
		X	Y	Z	REAL	IMAG.	MAG.		
1	1	.0000	.0000	.1942	.04662	-9.0545E-04	1.7153E-03	1.9397E-03	117.828

2	1	.0000	.0000	.2408	.04662	-7.8764E-04	1.5063E-03	1.6998E-03	117.604
3	1	.0000	.0000	.2875	.04662	-5.5895E-04	1.0891E-03	1.2241E-03	117.169
4	1	.0000	.0000	.3341	.04662	-2.2826E-04	4.5625E-04	5.1016E-04	116.579
5	2	.1827	.0000	.0000	.05470	1.5026E-02	-6.9134E-03	1.6540E-02	-24.707
6	2	.2374	.0000	.0000	.05470	1.3800E-02	-7.4045E-03	1.5661E-02	-28.217
7	2	.2921	.0000	.0000	.05470	1.1401E-02	-6.7803E-03	1.3265E-02	-30.741
8	2	.3468	.0000	.0000	.05470	7.8886E-03	-5.0213E-03	9.3511E-03	-32.478
9	2	.4015	.0000	.0000	.05470	3.2560E-03	-2.1815E-03	3.9192E-03	-33.822

--- SURFACE PATCH CURRENTS ---

DISTANCE IN WAVELENGTHS
CURRENT IN AMPS/METER

PATCH CENTER			--- SURFACE COMPONENTS ---				--- RECTANGULAR COMPONENTS ---						
X	Y	Z	TANGENT VECTOR 1	TANGENT VECTOR 2		X	Y	Z					
			MAG.	PHASE	MAG.	PHASE	REAL	IMAG.	REAL	IMAG.	REAL	IMAG.	
1	.155	.000	.114	4.9007E-09	-74.04	4.0390E-02	140.22	0.00E-01	0.00E-01	1.35E-09	-4.71E-09	-3.10E-02	2.58E-02
2	.155	.024	.024	8.6314E-02	153.29	8.8849E-02	152.99	-0.00E-01	0.00E-01	-7.71E-02	3.88E-02	-7.92E-02	4.04E-02
3	.155	-.024	.024	8.6314E-02	-26.71	8.8849E-02	152.99	0.00E-01	0.00E-01	7.71E-02	-3.88E-02	-7.92E-02	4.04E-02
4	.155	-.024	-.024	8.6311E-02	-26.71	9.1285E-02	-26.16	0.00E-01	-0.00E-01	7.71E-02	-3.88E-02	8.19E-02	-4.02E-02
5	.155	.024	-.024	8.6311E-02	153.29	9.1285E-02	-26.16	0.00E-01	0.00E-01	-7.71E-02	3.88E-02	8.19E-02	-4.02E-02
6	.155	.000	-.114	3.9029E-09	-82.46	4.1813E-02	-37.70	0.00E-01	-0.00E-01	5.12E-10	-3.87E-09	3.31E-02	-2.56E-02
7	.135	.078	.114	1.7533E-02	121.83	2.2201E-02	129.65	4.62E-03	-7.45E-03	-8.01E-03	1.29E-02	-1.42E-02	1.71E-02
8	.135	.078	.000	3.7640E-02	141.92	1.3236E-03	2.35	1.48E-02	-1.16E-02	-2.57E-02	2.01E-02	1.32E-03	5.43E-05
9	.135	.078	-.114	1.7516E-02	121.83	2.3096E-02	-45.71	4.62E-03	-7.44E-03	-8.00E-03	1.29E-02	1.61E-02	-1.65E-02
10	.107	.000	.171	2.0213E-02	-85.04	8.2560E-09	-33.16	1.75E-03	-2.01E-02	6.91E-09	-4.52E-09	0.00E-01	0.00E-01
11	.107	.000	-.171	1.6874E-02	-87.11	6.7417E-09	125.50	8.52E-04	-1.69E-02	3.91E-09	-5.49E-09	0.00E-01	-0.00E-01
12	.078	.135	.114	1.6710E-02	87.52	6.2224E-03	106.04	-6.27E-04	-1.45E-02	3.62E-04	8.35E-03	-1.72E-03	5.98E-03
13	.078	.135	.000	1.5767E-02	103.50	1.3327E-03	2.80	3.19E-03	-1.33E-02	-1.84E-03	7.67E-03	1.33E-03	6.52E-05
14	.078	.135	-.114	1.6653E-02	87.44	6.8117E-03	-56.50	-6.43E-04	-1.44E-02	3.71E-04	8.32E-03	3.76E-03	-5.68E-03
15	0.000	.155	.114	1.3965E-02	55.64	1.7990E-03	89.81	-7.88E-03	-1.15E-02	-2.35E-10	-3.44E-10	5.87E-06	1.80E-03
16	0.000	.155	.000	1.1670E-02	60.48	1.3310E-03	3.41	-5.75E-03	-1.02E-02	-1.71E-10	-3.03E-10	1.33E-03	7.92E-05
17	0.000	.155	-.114	1.3951E-02	55.62	2.2807E-03	-31.00	-7.88E-03	-1.15E-02	-2.35E-10	-3.43E-10	1.95E-03	-1.17E-03
18	.054	.093	.171	9.5476E-03	-98.11	1.5574E-02	70.78	-5.11E-03	-1.75E-02	1.40E-03	-8.33E-04	-0.00E-01	-0.00E-01
19	.054	.093	-.171	6.5730E-03	-109.90	1.5542E-02	-109.24	-5.56E-03	-1.58E-02	6.24E-04	1.98E-03	0.00E-01	0.00E-01
20	-.078	.135	.114	1.2623E-02	34.28	1.5698E-03	179.32	-9.03E-03	-6.16E-03	-5.22E-03	-3.55E-03	-1.57E-03	1.86E-05
21	-.078	.135	.000	9.6162E-03	34.25	1.3372E-03	3.28	-6.88E-03	-4.69E-03	-3.97E-03	-2.71E-03	1.33E-03	7.65E-05
22	-.078	.135	-.114	1.2602E-02	34.42	3.6441E-03	5.05	-9.00E-03	-6.17E-03	-5.20E-03	-3.56E-03	3.63E-03	3.21E-04
23	-.135	.078	.114	6.7432E-03	22.42	4.2065E-03	-179.29	-3.12E-03	-1.29E-03	-5.40E-03	-2.23E-03	-4.21E-03	-5.18E-05
24	-.135	.078	.000	5.6060E-03	21.56	1.3441E-03	3.20	-2.61E-03	-1.03E-03	-4.52E-03	-1.78E-03	1.34E-03	7.51E-05
25	-.135	.078	-.114	6.7304E-03	22.44	6.2415E-03	6.27	-3.11E-03	-1.28E-03	-5.39E-03	-2.22E-03	6.20E-03	6.81E-04
26	-.054	.093	.171	5.5922E-03	3.15	1.3634E-02	38.74	-1.20E-02	-7.54E-03	-4.82E-04	-4.00E-03	0.00E-01	0.00E-01
27	-.054	.093	-.171	5.8821E-03	37.27	1.3609E-02	-141.24	-1.15E-02	-9.16E-03	-1.25E-03	-1.18E-03	0.00E-01	0.00E-01
28	-.155	0.000	.114	3.3602E-09	-155.80	4.2242E-03	178.48	-1.83E-16	-8.21E-17	3.06E-09	1.38E-09	-4.22E-03	1.12E-04
29	-.155	0.000	.000	4.2238E-09	86.14	1.3471E-03	3.05	1.70E-17	2.51E-16	-2.84E-10	-4.21E-09	1.35E-03	7.17E-05
30	-.155	0.000	-.114	3.1906E-09	162.32	6.3063E-03	2.13	-1.81E-16	5.78E-17	3.04E-09	-9.69E-10	6.30E-03	2.34E-04
31	-.135	-.078	.114	6.7433E-03	-157.58	4.2065E-03	-179.29	-3.12E-03	-1.29E-03	5.40E-03	2.23E-03	-4.21E-03	-5.18E-05
32	-.135	-.078	.000	5.6060E-03	-158.44	1.3441E-03	3.20	-2.61E-03	-1.03E-03	4.52E-03	1.78E-03	1.34E-03	7.51E-05

33													
-.135	-.078	-.114	6.7304E-03	-157.56	6.2415E-03	6.27	-3.11E-03	-1.28E-03	5.39E-03	2.22E-03	6.20E-03	6.81E-04	
34													
-.107	0.000	.171	1.1520E-02	9.48	2.5895E-09	-158.89	-1.14E-02	-1.90E-03	1.74E-09	8.20E-10	0.00E-01	0.00E-01	
35													
-.107	0.000	-.171	1.1648E-02	26.24	2.0681E-09	12.28	-1.04E-02	-5.15E-03	1.40E-09	1.33E-10	0.00E-01	0.00E-01	
36													
-.078	-.135	.114	1.2623E-02	-145.72	1.5698E-03	179.32	-9.03E-03	-6.16E-03	5.22E-03	3.55E-03	-1.57E-03	1.86E-05	
37													
-.078	-.135	.000	9.6162E-03	-145.75	1.3372E-03	3.28	-6.88E-03	-4.69E-03	3.97E-03	2.71E-03	1.33E-03	7.65E-05	
38													
-.078	-.135	-.114	1.2602E-02	-145.58	3.6441E-03	5.05	-9.00E-03	-6.17E-03	5.20E-03	3.56E-03	3.63E-03	3.21E-04	
39													
0.000	-.155	.114	1.3965E-02	-124.36	1.7990E-03	89.81	-7.88E-03	-1.15E-02	-9.40E-10	-1.37E-09	5.87E-06	1.80E-03	
40													
0.000	-.155	.000	1.1670E-02	-119.52	1.3310E-03	3.41	-5.75E-03	-1.02E-02	-6.85E-10	-1.21E-09	1.33E-03	7.92E-05	
41													
0.000	-.155	-.114	1.3951E-02	-124.38	2.2807E-03	-31.00	-7.88E-03	-1.15E-02	-9.39E-10	-1.37E-09	1.95E-03	-1.17E-03	
42													
-.054	-.093	.171	5.5922E-03	3.15	1.3634E-02	-141.26	-1.20E-02	-7.54E-03	4.82E-04	4.00E-03	0.00E-01	0.00E-01	
43													
-.054	-.093	-.171	5.8821E-03	37.27	1.3609E-02	38.76	-1.15E-02	-9.16E-03	1.25E-03	1.18E-03	0.00E-01	0.00E-01	
44													
.078	-.135	.114	1.6710E-02	-92.48	6.2224E-03	106.04	-6.27E-04	-1.45E-02	-3.62E-04	-8.35E-03	-1.72E-03	5.98E-03	
45													
.078	-.135	.000	1.5767E-02	-76.50	1.3327E-03	2.80	3.19E-03	-1.33E-02	1.84E-03	-7.67E-03	1.33E-03	6.52E-05	
46													
.078	-.135	-.114	1.6653E-02	-92.56	6.8117E-03	-56.50	-6.43E-04	-1.44E-02	-3.71E-04	-8.32E-03	3.76E-03	-5.68E-03	
47													
.135	-.078	.114	1.7533E-02	-58.17	2.2201E-02	129.65	4.62E-03	-7.45E-03	8.01E-03	-1.29E-02	-1.42E-02	1.71E-02	
48													
.135	-.078	.000	3.7640E-02	-38.08	1.3236E-03	2.35	1.48E-02	-1.16E-02	2.57E-02	-2.01E-02	1.32E-03	5.43E-05	
49													
.135	-.078	-.114	1.7516E-02	-58.17	2.3096E-02	-45.71	4.62E-03	-7.44E-03	8.00E-03	-1.29E-02	1.61E-02	-1.65E-02	
50													
.054	-.093	.171	9.5476E-03	-98.11	1.5574E-02	-109.22	-5.11E-03	-1.75E-02	-1.40E-03	8.33E-04	0.00E-01	0.00E-01	
51													
.054	-.093	-.171	6.5730E-03	-109.90	1.5542E-02	70.76	-5.56E-03	-1.58E-02	-6.24E-04	-1.98E-03	-0.00E-01	-0.00E-01	
52													
.026	.026	.171	2.0110E-02	-97.14	8.6899E-03	-62.33	-2.50E-03	-2.00E-02	4.04E-03	-7.70E-03	-0.00E-01	0.00E-01	
53													
-.026	.026	.171	1.2974E-02	-174.05	8.9441E-03	-64.51	-1.29E-02	-1.35E-03	3.85E-03	-8.07E-03	-0.00E-01	0.00E-01	
54													
-.026	-.026	.171	1.2974E-02	-174.05	8.9441E-03	115.49	-1.29E-02	-1.35E-03	-3.85E-03	8.07E-03	0.00E-01	-0.00E-01	
55													
.026	-.026	.171	2.0110E-02	-97.14	8.6899E-03	117.67	-2.50E-03	-2.00E-02	-4.04E-03	7.70E-03	0.00E-01	-0.00E-01	
56													
.000	.000	-.171	1.3088E-02	-126.31	3.1078E-09	137.30	-7.75E-03	-1.05E-02	2.28E-09	-2.11E-09	0.00E-01	-0.00E-01	

- - - POWER BUDGET - - -

INPUT POWER = 7.5128E-03 WATTS
 RADIATED POWER= 7.5128E-03 WATTS
 STRUCTURE LOSS= 0.0000E-01 WATTS
 NETWORK LOSS = 0.0000E-01 WATTS
 EFFICIENCY = 100.00 PERCENT

- - - ISOLATION DATA - - -

- - COUPLING BETWEEN - -						- - - FOR MAXIMUM COUPLING - - -					
TAG/SEG.	NO.	TAG/'	SEG.	NO.	MAXIMUM COUPLING (DB)	LOAD IMPEDANCE (2ND SEG.)		INPUT IMPEDANCE			
						REAL	IMAG.	REAL	IMAG.		
1	1	1	2	1	5	-13.709	5.58249E+01	-2.06395E+01	1.82294E+01	-1.16438E+02	

***** DATA CARD NO. 7 EN 0 0 0 0 0.00000E-01 0.00000E-01 0.00000E-01 0.00000E-01 0.00000E-01 0.00000E-01

RUN TIME = .000

Examples 7 and 8

Examples 7 and 8 demonstrate the use of NEC for scattering. The columns labeled "gain" are, in this case, scattering cross section in square wavelengths (σ/λ^2). Example 8 is a stick model of an aircraft as shown in **Figure 19**.

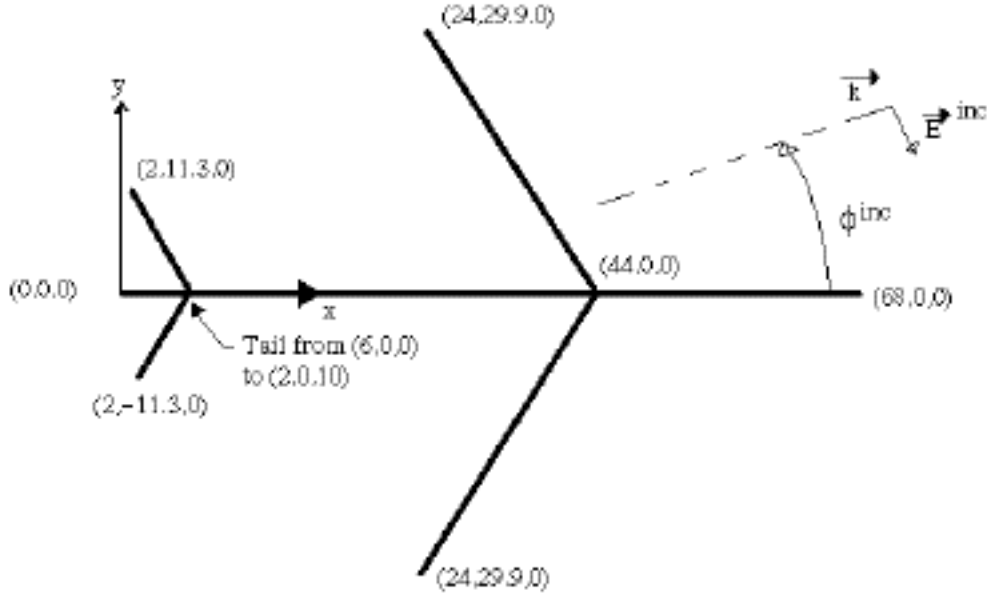

Figure 19. Stick model of aircraft.

Input:

```

CMSAMPLE PROBLEM FOR NEC
CESTICK MODEL OF AIRCRAFT - FREE SPACE
GW 1, 1, 0., 0., 0., 6., 0., 0., 1.,
GW 2 6 6. 0. 0. 44. 0. 0. 1.
GW 3 4 44. 0. 0. 68. 0. 0. 1.
GW 4 6 44. 0. 0. 24. 29.9 0. 1.
GW 5 6 44. 0. 0. 24. -29.9 0. 1.
GW 6 2 6. 0. 0. 2. 11.3 0. 1.
GW 7 2 6. 0. 0. 2. -11.3 0. 1.
GW 8 2 6. 0. 0. 2. 0. 10. 1.
GE
FR 0 1 0 0 3.
EX 1 1 1 0 0.
RP 0 1 1 1000 0. 0. 0.
EX 1 1 1 0 90. 30. -90.
RP 0 1 1 1000 90. 30.
EN
    
```

Output:

1

- - - - COMMENTS - - - -

SAMPLE PROBLEM FOR NEC
STICK MODEL OF AIRCRAFT - FREE SPACE

- - - STRUCTURE SPECIFICATION - - -

COORDINATES MUST BE INPUT IN
METERS OR BE SCALED TO METERS
BEFORE STRUCTURE INPUT IS ENDED

WIRE NO.	X1	Y1	Z1	X2	Y2	Z2	RADIUS	NO. OF SEG.	FIRST SEG.	LAST SEG.	TAG NO.
1	.00000	.00000	.00000	6.00000	.00000	.00000	1.00000	1	1	1	1
2	6.00000	.00000	.00000	44.00000	.00000	.00000	1.00000	6	2	7	2
3	44.00000	.00000	.00000	68.00000	.00000	.00000	1.00000	4	8	11	3
4	44.00000	.00000	.00000	24.00000	29.90000	.00000	1.00000	6	12	17	4
5	44.00000	.00000	.00000	24.00000	-29.90000	.00000	1.00000	6	18	23	5
6	6.00000	.00000	.00000	2.00000	11.30000	.00000	1.00000	2	24	25	6
7	6.00000	.00000	.00000	2.00000	-11.30000	.00000	1.00000	2	26	27	7
8	6.00000	.00000	.00000	2.00000	.00000	10.00000	1.00000	2	28	29	8

TOTAL SEGMENTS USED= 29 NO. SEG. IN A SYMMETRIC CELL= 29 SYMMETRY FLAG= 0

- MULTIPLE WIRE JUNCTIONS -

JUNCTION	SEGMENTS (- FOR END 1, + FOR END 2)
1	1 -2 -24 -26 -28
2	7 -8 -12 -18

- - - - SEGMENTATION DATA - - - -

COORDINATES IN METERS

I+ AND I- INDICATE THE SEGMENTS BEFORE AND AFTER I

SEG. NO.	COORDINATES OF SEG. CENTER			SEG. LENGTH	ORIENTATION ANGLES		WIRE RADIUS	CONNECTION DATA			TAG NO.
	X	Y	Z		ALPHA	BETA		I-	I	I+	
1	3.00000	.00000	.00000	6.00000	.00000	.00000	1.00000	0	1	2	1
2	9.16667	.00000	.00000	6.33333	.00000	.00000	1.00000	-24	2	3	2
3	15.50000	.00000	.00000	6.33333	.00000	.00000	1.00000	2	3	4	2
4	21.83334	.00000	.00000	6.33333	.00000	.00000	1.00000	3	4	5	2
5	28.16667	.00000	.00000	6.33333	.00000	.00000	1.00000	4	5	6	2
6	34.50000	.00000	.00000	6.33333	.00000	.00000	1.00000	5	6	7	2
7	40.83334	.00000	.00000	6.33333	.00000	.00000	1.00000	6	7	8	2
8	47.00000	.00000	.00000	6.00000	.00000	.00000	1.00000	-12	8	9	3
9	53.00000	.00000	.00000	6.00000	.00000	.00000	1.00000	8	9	10	3
10	59.00000	.00000	.00000	6.00000	.00000	.00000	1.00000	9	10	11	3
11	65.00000	.00000	.00000	6.00000	.00000	.00000	1.00000	10	11	0	3
12	42.33334	2.49167	.00000	5.99539	.00000	123.77841	1.00000	-18	12	13	4
13	39.00000	7.47500	.00000	5.99539	.00000	123.77841	1.00000	12	13	14	4
14	35.66667	12.45833	.00000	5.99539	.00000	123.77841	1.00000	13	14	15	4
15	32.33334	17.44167	.00000	5.99539	.00000	123.77843	1.00000	14	15	16	4
16	29.00000	22.42500	.00000	5.99539	.00000	123.77843	1.00000	15	16	17	4
17	25.66667	27.40833	.00000	5.99539	.00000	123.77843	1.00000	16	17	0	4
18	42.33334	-2.49167	.00000	5.99539	.00000	-123.77841	1.00000	7	18	19	5
19	39.00000	-7.47500	.00000	5.99539	.00000	-123.77841	1.00000	18	19	20	5
20	35.66667	-12.45833	.00000	5.99539	.00000	-123.77841	1.00000	19	20	21	5
21	32.33334	-17.44167	.00000	5.99539	.00000	-123.77843	1.00000	20	21	22	5
22	29.00000	-22.42500	.00000	5.99539	.00000	-123.77843	1.00000	21	22	23	5
23	25.66667	-27.40833	.00000	5.99539	.00000	-123.77843	1.00000	22	23	0	5
24	5.00000	2.82500	.00000	5.99354	.00000	109.49310	1.00000	-26	24	25	6
25	3.00000	8.47500	.00000	5.99354	.00000	109.49310	1.00000	24	25	0	6
26	5.00000	-2.82500	.00000	5.99354	.00000	-109.49310	1.00000	-28	26	27	7
27	3.00000	-8.47500	.00000	5.99354	.00000	-109.49310	1.00000	26	27	0	7
28	5.00000	.00000	2.50000	5.38516	68.19859	180.00000	1.00000	1	28	29	8
29	3.00000	.00000	7.50000	5.38516	68.19859	180.00000	1.00000	28	29	0	8

```

***** DATA CARD NO. 1 FR 0 1 0 0 3.00000E+00 0.00000E-01 0.00000E-01 0.00000E-01 0.00000E-01 0.00000E-01
***** DATA CARD NO. 2 EX 1 1 1 0 0.00000E-01 0.00000E-01 0.00000E-01 0.00000E-01 0.00000E-01 0.00000E-01
***** DATA CARD NO. 3 RP 0 1 1 1000 0.00000E-01 0.00000E-01 0.00000E-01 0.00000E-01 0.00000E-01 0.00000E-01
    
```

----- FREQUENCY -----

FREQUENCY= 3.0000E+00 MHZ
 WAVELENGTH= 9.9933E+01 METERS

APPROXIMATE INTEGRATION EMPLOYED FOR SEGMENTS MORE THAN 1.000 WAVELENGTHS APART

--- STRUCTURE IMPEDANCE LOADING ---

THIS STRUCTURE IS NOT LOADED

--- ANTENNA ENVIRONMENT ---

FREE SPACE

--- MATRIX TIMING ---

FILL= .000 SEC., FACTOR= .000 SEC.

--- EXCITATION ---

PLANE WAVE THETA= .00 DEG, PHI= .00 DEG, ETA= .00 DEG, TYPE -LINEAR= AXIAL RATIO= .000

--- CURRENTS AND LOCATION ---

DISTANCES IN WAVELENGTHS

SEG. NO.	TAG NO.	COORD. OF SEG. CENTER			SEG. LENGTH	--- CURRENT (AMPS) ---			PHASE
		X	Y	Z		REAL	IMAG.	MAG.	
1	1	.0300	.0000	.0000	.06004	1.4998E-03	4.6949E-03	4.9286E-03	72.284
2	2	.0917	.0000	.0000	.06338	3.2097E-02	-1.7023E-02	3.6332E-02	-27.939
3	2	.1551	.0000	.0000	.06338	3.7967E-02	-3.1079E-02	4.9065E-02	-39.303
4	2	.2185	.0000	.0000	.06338	4.4300E-02	-4.9461E-02	6.6399E-02	-48.151
5	2	.2819	.0000	.0000	.06338	4.9342E-02	-6.7069E-02	8.3264E-02	-53.658
6	2	.3452	.0000	.0000	.06338	5.2034E-02	-7.9829E-02	9.5290E-02	-56.903
7	2	.4086	.0000	.0000	.06338	5.1637E-02	-8.4841E-02	9.9319E-02	-58.674
8	3	.4703	.0000	.0000	.06004	2.0877E-01	-2.0895E-01	2.9537E-01	-45.025
9	3	.5304	.0000	.0000	.06004	1.7843E-01	-1.7850E-01	2.5239E-01	-45.010
10	3	.5904	.0000	.0000	.06004	1.2813E-01	-1.2752E-01	1.8077E-01	-44.865
11	3	.6504	.0000	.0000	.06004	5.9205E-02	-5.8276E-02	8.3074E-02	-44.547
12	4	.4236	.0249	.0000	.05999	-8.3232E-02	6.6192E-02	1.0634E-01	141.506
13	4	.3903	.0748	.0000	.05999	-8.3105E-02	6.5612E-02	1.0588E-01	141.709
14	4	.3569	.1247	.0000	.05999	-7.6168E-02	5.8725E-02	9.6178E-02	142.368
15	4	.3235	.1745	.0000	.05999	-6.2518E-02	4.6263E-02	7.7773E-02	143.499
16	4	.2902	.2244	.0000	.05999	-4.3490E-02	3.0212E-02	5.2954E-02	145.212
17	4	.2568	.2743	.0000	.05999	-1.9544E-02	1.2375E-02	2.3132E-02	147.657
18	5	.4236	-.0249	.0000	.05999	-8.3232E-02	6.6192E-02	1.0634E-01	141.506
19	5	.3903	-.0748	.0000	.05999	-8.3105E-02	6.5612E-02	1.0588E-01	141.709
20	5	.3569	-.1247	.0000	.05999	-7.6167E-02	5.8725E-02	9.6178E-02	142.368
21	5	.3235	-.1745	.0000	.05999	-6.2517E-02	4.6263E-02	7.7773E-02	143.499
22	5	.2902	-.2244	.0000	.05999	-4.3489E-02	3.0212E-02	5.2954E-02	145.212
23	5	.2568	-.2743	.0000	.05999	-1.9544E-02	1.2375E-02	2.3132E-02	147.657
24	6	.0500	.0283	.0000	.05998	-1.0118E-02	5.2357E-03	1.1393E-02	152.641
25	6	.0300	.0848	.0000	.05998	-4.6178E-03	1.7838E-03	4.9503E-03	158.879
26	7	.0500	-.0283	.0000	.05998	-1.0118E-02	5.2356E-03	1.1393E-02	152.641
27	7	.0300	-.0848	.0000	.05998	-4.6178E-03	1.7838E-03	4.9503E-03	158.879
28	8	.0500	.0000	.0250	.05389	-5.2942E-03	5.3453E-03	7.5234E-03	134.725
29	8	.0300	.0000	.0751	.05389	-1.5854E-03	2.0520E-03	2.5931E-03	127.691

--- RADIATION PATTERNS ---

-- ANGLES --		- POWER GAINS -			--- POLARIZATION ---			--- E(THETA) ---		--- E(PHI) ---	
THETA	PHI	VERT.	HOR.	TOTAL	AXIAL	TILT	SENSE	MAGNITUDE	PHASE	MAGNITUDE	PHASE
DEGREES	DEGREES	DB	DB	DB	RATIO	DEG.		VOLTS/M	DEGREES	VOLTS/M	DEGREES
.00	.00	-2.98	-134.64	-2.98	0.00000	0.00	LINEAR	2.00019E+01	-133.97	5.22797E-06	78.18

***** DATA CARD NO. 4 EX 1 1 1 0 9.00000E+01 3.00000E+01 -9.00000E+01 0.00000E-01 0.00000E-01 0.00000E-01 0.00000E-01
 ***** DATA CARD NO. 5 RP 0 1 1 1000 9.00000E+01 3.00000E+01 0.00000E-01 0.00000E-01 0.00000E-01 0.00000E-01 0.00000E-01

--- EXCITATION ---

PLANE WAVE THETA= 90.00 DEG, PHI= 30.00 DEG, ETA= -90.00 DEG, TYPE -LINEAR= AXIAL RATIO= .000

--- CURRENTS AND LOCATION ---

DISTANCES IN WAVELENGTHS

SEG. NO.	TAG NO.	COORD. OF SEG. CENTER			SEG. LENGTH	--- CURRENT (AMPS) ---			
		X	Y	Z		REAL	IMAG.	MAG.	PHASE
1	1	.0300	.0000	.0000	.06004	2.1951E-03	3.6163E-03	4.2304E-03	58.741
2	2	.0917	.0000	.0000	.06338	6.5448E-03	3.5229E-03	7.4327E-03	28.292
3	2	.1551	.0000	.0000	.06338	7.4389E-03	-5.7723E-03	9.4158E-03	-37.810
4	2	.2185	.0000	.0000	.06338	9.8856E-03	-1.9791E-02	2.2123E-02	-63.458
5	2	.2819	.0000	.0000	.06338	1.4293E-02	-3.5271E-02	3.8057E-02	-67.941
6	2	.3452	.0000	.0000	.06338	2.0095E-02	-4.8858E-02	5.2829E-02	-67.643
7	2	.4086	.0000	.0000	.06338	2.5574E-02	-5.7699E-02	6.3113E-02	-66.095
8	3	.4703	.0000	.0000	.06004	-3.8608E-02	1.5511E-01	1.5984E-01	103.977
9	3	.5304	.0000	.0000	.06004	-2.7542E-02	1.3176E-01	1.3460E-01	101.807
10	3	.5904	.0000	.0000	.06004	-1.4290E-02	9.3988E-02	9.5068E-02	98.645
11	3	.6504	.0000	.0000	.06004	-3.4927E-03	4.3257E-02	4.3398E-02	94.616
12	4	.4236	.0249	.0000	.05999	-2.3663E-02	-2.1177E-01	2.1309E-01	-96.376
13	4	.3903	.0748	.0000	.05999	-1.6403E-02	-2.0488E-01	2.0554E-01	-94.577
14	4	.3569	.1247	.0000	.05999	-7.9417E-03	-1.8318E-01	1.8335E-01	-92.483
15	4	.3235	.1745	.0000	.05999	-3.7479E-04	-1.4723E-01	1.4723E-01	-90.146
16	4	.2902	.2244	.0000	.05999	4.5369E-03	-1.0032E-01	1.0042E-01	-87.411
17	4	.2568	.2743	.0000	.05999	4.5311E-03	-4.4057E-02	4.4289E-02	-84.128
18	5	.4236	-.0249	.0000	.05999	9.4628E-02	-8.9035E-03	9.5046E-02	-5.375
19	5	.3903	-.0748	.0000	.05999	9.3141E-02	-9.9663E-03	9.3673E-02	-6.108
20	5	.3569	-.1247	.0000	.05999	8.5085E-02	-7.7993E-03	8.5442E-02	-5.237
21	5	.3235	-.1745	.0000	.05999	7.0545E-02	-3.6568E-03	7.0639E-02	-2.967
22	5	.2902	-.2244	.0000	.05999	5.0363E-02	3.7764E-04	5.0364E-02	.430
23	5	.2568	-.2743	.0000	.05999	2.3641E-02	1.8773E-03	2.3715E-02	4.540
24	6	.0500	.0283	.0000	.05998	1.1756E-02	-3.7554E-02	3.9351E-02	-72.617
25	6	.0300	.0848	.0000	.05998	7.3151E-03	-2.2549E-02	2.3706E-02	-72.026
26	7	.0500	-.0283	.0000	.05998	-1.0447E-02	3.6781E-02	3.8236E-02	105.856
27	7	.0300	-.0848	.0000	.05998	-4.9516E-03	2.0995E-02	2.1571E-02	103.270
28	8	.0500	.0000	.0250	.05389	-4.6027E-03	-1.6751E-03	4.8981E-03	-160.001
29	8	.0300	.0000	.0751	.05389	-2.6265E-03	-1.6650E-03	3.1098E-03	-147.629

--- RADIATION PATTERNS ---

-- ANGLES --		- POWER GAINS -			--- POLARIZATION ---			--- E(THETA) ---		--- E(PHI) ---	
THETA	PHI	VERT.	HOR.	TOTAL	AXIAL	TILT	SENSE	MAGNITUDE	PHASE	MAGNITUDE	PHASE
DEGREES	DEGREES	DB	DB	DB	RATIO	DEG.		VOLTS/M	DEGREES	VOLTS/M	DEGREES
90.00	30.00	-51.77	-9.79	-9.79	.00000	89.54	LINEAR	7.27501E-02	-52.29	9.13410E+00	-52.98

***** DATA CARD NO. 6 EN 0 0 0 0 0.00000E-01 0.00000E-01 0.00000E-01 0.00000E-01 0.00000E-01 0.00000E-01 0.00000E-01

RUN TIME = .000

V. EXECUTION TIME

The program execution time depends on the number of patches and the number of wire segments used. The central processor time approximately follows the formula:

$$T = T_1 + T_2 + T_3 + T_4$$

$$T_1 = (A_1 k N_s^2 + A_2 k N_s^2 + A_3 k N_s N_p + A_4 N_c) / M,$$

$$T_2 = B (N_s + 2 N_p)^3 / M^2,$$

$$T_3 = C N_s + 2 N_p / M,$$

$$T_4 = D k N_f (N_s + 2 N_p),$$

where

N_s = number of wire segments,
 N_p = number of surface Patches,
 N_c = number of connections between a wire and surface,
 N_e = number of different excitations,
 N_f = number of far-field calculation points
 M = number of degrees of symmetry,

k =

1 for structure in free space,
 2 for perfect ground of reflection coefficient approximation, and
 4 for Sommerfeld/Norton method. T_1 is the time to fill the interaction matrix; T_2 is the time to factor the matrix; T_3 is the time to solve for the currents for all excitations; and T_4 is the time to calculate far fields.

The proportionality factors depend on the computer system on which the program is run. The factors in seconds for a CDC 7600 computer when the matrix fits in core are roughly

$A_1 = 3 \cdot (10^{-4})$,
 $A_2 = 5 \cdot (10^{-5})$,
 $A_3 = 5 \cdot (10^{-4})$,
 $A_4 = 2 \cdot (10^{-2})$,
 $B = 2 \cdot (10^{-6})$,
 $C = 4 \cdot (10^{-6})$, and
 $D = 6 \cdot (10^{-5})$. When the extended thin-wire kernel is used, A_1 is increased by about 18 percent. If the approximation for large interaction distances is used with $RKH = R_0$, then A_1 is multiplied by $(1 - 0.7F)$ where F is the fraction of all segment pairs for which the separation is greater than R_0 .

Unless a large number of excitations or far fields are requested, T_1 and T_2 will account for nearly all of the running time. If the matrix does not fit in core storage, T_1 and T_2 will be larger than indicated above. They may be much larger if I/O time is included.

The code SOMNEC requires about 15 sec to write the Sommerfeld/Norton data file on a CDC 7600 computer.

Benchmark Times on Various Platforms

(This subsection was not part of the original NEC-2 manual.)

Here's a compilation of NEC-4.1 and NEC-2 performance on various PC platforms. This may be of interest to NEC users... I find NEC-4.1 a good way to benchmark PCs for real world use!

Larry, WA6JYJ/7
 laitinen@eshop.uoregon.edu

Rev: 8-NOV-95

PC PROCESSOR AND MOTHERBOARD BENCHMARKS USING THE NEC4.1 AND NEC2
METHOD OF MOMENTS ANTENNA ANALYSIS CODES

NEC4.1 and NEC2 double precision Method of Moments antenna analysis codes were used to compare the performance of various 80x86 CPU chips and motherboards. A center fed half-wave dipole antenna was analyzed with 299 segments. The total execution and the impedance matrix fill and factor times reported by NEC are shown in the following two tables.

A. NEC4.1 EXECUTION TIMES IN SECONDS FOR THE TEST299.NEC INPUT FILE.

	CPU/MOTHERBOARD	CACHE	RAM	MATRIX FILL	MATRIX FACTOR	TOTAL EXEC
1.	Pentium 120-MHz Gigabyte/Intel Triton	256KB PBURST	32MB FPM	14.07	7.88	22.75
2.	Pentium 100-MHz Triton Super Micro P55CMS	512KB PBURST	16MB EDO	15.87	8.53	25.15
3.	Pentium 100-MHz Gigabyte/Intel Triton	256KB PBURST	32MB FPM	15.96	8.73	25.45
4.	Pentium 100-MHz Triton Super Micro P55CMS	512KB PBURST	64MB FPM	16.12	8.63	25.50
5.	Pentium 100-MHz Triton Micronics M54Hi PCI/ISA	256KB PBURST	64MB FPM	16.22	8.93	25.85
6.	Pentium 120-MHz Gigabyte/Intel Triton	256KB SRAM	32MB FPM	15.42	10.18	26.40
7.	Pentium 100-MHz Intel P54C-PCI/Neptune	256KB SRAM	16MB FPM	16.97	9.58	27.30
8.	Pentium 90-MHz Gigabyte/Intel Triton	256KB PBURST	32MB FPM	17.71	9.73	28.49
9.	Pentium 100-MHz Gigabyte/Intel Triton	256KB SRAM	32MB FPM	17.16	10.77	28.69
10.	Pentium 90-MHz Dell/Intel Neptune?	256KB SRAM	32MB FPM	18.76	10.57	30.19
11.	Pentium 90-MHz Intel P54C-PCI/Neptune	256KB SRAM	16MB FPM	18.80	10.60	30.23
12.	Pentium 90-MHz Gigabyte/Intel Triton	256KB SRAM	32MB FPM	18.91	11.97	31.78
13.	Pentium 60-MHz Dell system	256KB SRAM	16MB FPM	27.09	16.92	45.16
14.	Pentium 75-MHz Gateway-2000 P5-75	256KB SRAM	8MB FPM	29.89	15.02	48.35*
15.	Intel 80486DX4-100 Gigabyte PCI "AM" MB	256KB SRAM	16MB FPM	32.59	21.16	55.38
16.	Intel 80486DX4-100 Gigabyte PCI "AM" MB	256KB SRAM	16MB FPM	33.08	23.50	58.33
17.	AMD AM486DX4-100 Gigabyte PCI "AM" MB	256KB SRAM	16MB FPM	36.63	22.26	60.53
18.	AMD AM486DX4-100 Gigabyte PCI "AM" MB	256KB SRAM	16MB FPM	40.36	24.96	67.06
19.	Intel 80486DX2-66 Gigabyte EISA MB	512KB SRAM	16MB FPM	56.29	32.78	93.01

B. NEC2 EXECUTION TIMES IN INTEGER SECONDS FOR THE TEST299.NEC INPUT FILE.

Although the NEC2 fill, factor and execution times are less precise than those in NEC4.1, they are included here because NEC2 is more widely distributed than NEC4.1. Further, some configurations tested here were not tested under NEC4.1.

	CPU/MOTHERBOARD	CACHE	RAM	MATRIX FILL	MATRIX FACTOR	TOTAL EXEC
1.	Pentium 120-MHz Gigabyte/Intel Triton	256KB PBURST	32MB FPM	11	11	22
2.	Pentium 120-MHz Gigabyte/Intel Triton	256KB SRAM	32MB FPM	13	12	25
3.	Pentium 100-MHz Gigabyte/Intel Triton	256KB PBURST	32MB FPM	13	12	25
4.	Pentium 100-MHz Intel P54C-PCI/Neptune	256KB SRAM	16MB FPM	13	13	27
5.	Pentium 100-MHz Gigabyte/Intel Triton	256KB SRAM	32MB FPM	14	14	28
6.	Pentium 90-MHz Gigabyte/Intel Triton	256KB PBURST	32MB FPM	15	13	28
7.	Pentium 90-MHz Intel P54C-PCI/Neptune	256KB SRAM	16MB FPM	15	14	29
8.	Pentium 90-MHz Intel ZAPPA/Triton	256KB SRAM	16MB FPM	15	17	32
9.	Pentium 90-MHz Gigabyte/Intel Triton	256KB SRAM	32MB FPM	15	16	31
10.	Pentium 75-MHz Gateway-2000 P5-75	256KB SRAM	8MB FPM	18	21	40*
11.	Intel 80486DX4-100 Gigabyte PCI "AM" MB	256KB SRAM	16MB FPM	32	25	57
12.	Intel 80486DX2-66 Gigabyte EISA MB	512KB SRAM	16MB FPM	49	38	88

NOTES: FPM = Fast Page Mode; PBURST = Pipeline Burst cache;
 EDO = Extended Data Output; SRAM = Static RAM cache
 *Only 8-MB of RAM may adversely affect the performance of the
 Gateway-2000 P5-75 system.

NEC2 and NEC4.1 are double precision Method of Moments antenna analysis codes using 32-bit DOS extenders. The codes used herein do NOT take advantage of the Pentium's pipeline architecture. Compilers generating Pentium optimized code are expected to speed up the matrix factorization by 50 to 100%.

Motherboard costs (w/o CPU) are as follows: Micronics \$540, Intel P54C-PCI (Premiere-II/Neptune/Plato) \$178, Super Micro P55CMS \$420 (approx), Gigabyte GA-586AT (256KB Pburst cache) \$240, and Gigabyte PCI 80486AM \$123. Intel Pentium CPU prices have decreased significantly since Aug 95.

C. "TEST299" Benchmark Input Data File

David Pinion, P.E., submitted the following NEC "card deck" input data used in these tests:

```
CE CENTER FED HORIZONTAL HALF-WAVE DIPOLE OVER EXCELLENT GROUND.  
GW 1,299,-139.,0, 6.,+139.,0, 6., .001,  
GE 0,  
GN 1,  
FR 0,0,0,0, 0.54,  
EX 0, 1,150,0,1., 0.,  
RP 1, 1, 1,0000, 1.5, 0., 0., 0., 1000.,  
EN
```

VI. Differences Between NEC-2, NEC-1, and AMP2

The following are features of the NEC-1 code that differ from AMP2:

- * A new current expansion is used with continuous current and current derivative along wires. The expansion enforces a new condition at multiple-wire junctions and allows for current flowing onto the end cap at an open wire end
- * Where a wire connects to a surface, the surface-current expansion is related to the current at the base of the wire rather than at the center of the last wire segment.
- * An optional voltage source based on a discontinuity in current slope is available.
- * In the thin-wire approximation, the current filament is on the wire axis and the observation points are on the surface.
- * An optional extended thin-wire approximation is available.
- * Either a perfectly or imperfectly conducting ground may be used with surface patches.
- * Either a perfect or imperfect ground may be used in incident plane wave.
- * Some constants have been changed including the velocity of light (2.998×10^8 m/sec.) and the default frequency (299.8 MHz)
- * The wire-segment connection numbers have new meanings.
- * The radiated field is the field at a range R multiplied by R with R approaching infinity. In AMP and AMP2, the field is multiplied by R/λ .
- * Both near electric and magnetic fields may be computed. The NF card is no longer used.
- * Charge density may be printed for wires.
- * The PT card is no longer canceled by a new EX card.

The following are features of NEC-2 that differ from NEC-1:

- * The NGF option has been added.
- * The restart option has been removed.
- * The Sommerfeld/Norton method has been added.
- * Maximum coupling between antennas may be computed.
- * wires may have tapered radius and segment lengths
- * Patches may be specified as triangles, rectangles, or quadrangles.
- * Rectangular surfaces with multiple patches may be specified.
- * The SS card for surfaces has been eliminated.

Section VII - FILE STORAGE REQUIREMENTS

Depending on the requirements of a run, NEC-2 may use the following files.

- 11, 12, 13, 14, 15, 16 - scratch files for matrix manipulations.
- 20 - NGF file
- 21 - Sommerfeld/Norton data.

The scratch files are used only when the matrix will not fit into core storage. For a case that does not use the NGF (but may write a NGF file), there are five options for matrix storage. IF

- N = the number of equations (number of segments plus twice the number of patches),
- Nx = the number of equations for a symmetric section, and
- IR = number of complex numbers for the matrix in core storage (4000),

then the case, indicated by the value of ICASE in the code, are

1. matrix in core, no symmetry (N2 <= IR).
2. matrix in core, symmetry (NNx <= IR).
3. matrix in core, no symmetry (N2 >= IR).
4. matrix in core, symmetry blocks fit in core (NNx > IR, Nx2<= IR).
5. matrix out of core, symmetry blocks do not fit in core Nx2>IR).

File storage is used in cases 3,4 and 5. Only the four files (11,12,13 and 14) are used when the NGF is not in use. The size of each file is approximately [?]NNx words. If the computer system requires that the user specify the file size, a safety margin should be included in the request. A more accurate estimate of the file size is

$$L=2NNc[Nx/Nc],$$

Where

$$Nc= [IR]/(2N)]$$

and [] indicates truncation. Nc, which is the number of matrix columns in I/O block, must be at least 1.

When the NGF is used, all six scratch files may be required. For the NGF the matrix is partitioned into four sections as

$$\begin{bmatrix} A & B \\ C & D \end{bmatrix}$$

A is the matrix for the NGF structure and is factored before the NGF file is written. The storage case for A is indicated in the NGF table by the value of ICASE (see example 10 in section IV). When the NGF is used, matrix A is read from file 20 and, if ICASE is 3,4, or 5, is stored on file 13. The size of file 13 when the NGF is used is approximately:

ICASE	Length of file 13
3	4N2
4	2NNx
5	4NNx

There are four options for storage of the matrices B, C, and D. these are associated with the integer ICASE as follows:

ICASE

1. AR, B, C, and D fit in core together where
AR = A for ICASE =1 or 2,
= one I/O block of A for ICASE = 3 or 5,
= one submatrix for ICASE = 4
2. B, C, and D fit in core but not with AR. This is possible only for ICASE =3, 4, or 5 when A does not need dedicated space in core. AR and dB must also fit in core together.
3. B, C, and D do not fit in core, but D fits in core alone.
A and D must fit together if ICASE = 1 or 2.
4. D does not fit in core.

The sizes of matrices B, C, and D depend on the number of new unknowns N_n where

$$N_n = N_n + N_t + 2N_p + 10N_q$$

N_s = number of new segments added to NGF,

N_t = number of NGF segments connected to new segments or patches,

N_p = number of new patches,

N_q = number of NGF patches connected to new segments.

The sizes of matrices B and C are $2NN_n$ and the size of D is $2N_n^2$ words. The file lengths are approximately $2N_n^2$ words for files 11 and 12 and $2NN_n$ for files 14, 15 and 16. when ICASE is 1 these files are not used, and when ICASE is 2 file 16 is not used.

The length of the NGF file (20) is approximately $4N(N_x+3)$. The length of the Sommerfeld/Norton data file (21) is about 2200 words.

Section VIII - ERROR MESSAGES

1. CHECK DATA, PARAMETER SPECIFYING SEGMENT POSITION IN A GROUP OF EQUAL TAGS CANNOT BE ZERO.
Routine: ISEGNO
This error results from an input data error and may occur at any point where a tag number is used to identify a segment. Execution terminated. Data on the NT, TL, EX, and PT cards should be checked.
2. CONNECT - SEGMENT CONNECTION ERROR FOR SEGMENT __.
Routine: CONNECT
Possible causes: number of segments at a junction exceeds limit; segment lengths are zero; array overflow.
3. DATA FAULT ON LOADING CARD NO. =__ ITAG STEP1 =__ IS GREATER THAN ITAG STEP2 = __
Routine: MAIN
When several segments are loaded, the number of the second segment specified must be greater than the number of the first segment. Execution terminated.
4. EOF ON UNIT __ NBLKS = __ NEOF = __.
Routine: BLCKIN, entry point of BLCKOT
An end of file has been encountered while reading data from the unit. NBLKS determines how many records are read from the unit. NEOF is a flag to indicate which call to BLCKIN initiated the read. If NEOF = 777, this diagnostic is normal and execution will continue. Otherwise, an error is indicated and execution will terminate.
5. ERROR - ARC ANGLE EXCEEDS 360. DEGREES
Routine: ARC
Error on GA card.
6. ERROR - B LESS THAN A IN ROM2
Routine: ROM2
Program malfunction.
7. ERROR - FR/GN CARD IS NOT ALLOWED WITH N.G.F.
Routine: Main
See section III-5.
8. ERROR - CORNERS OF QUADRILATERAL PATCH DO NOT LIE IN A PLANE.
Routine: Patch
The four corners of a quadrilateral patch (SP card) must lie in a plane.
9. ERROR - COUPLING IS NOT BETWEEN 0 AND 1
Routine: Couple
Inaccuracy in solution or error in data.
10. ERROR - GF MUST BE FIRST GEOMETRY DATA CARD
Routine: DATAGN
See section III-5.
11. ERROR IN GROUND PARAMETERS - COMPLEX DIELECTRIC CONSTANT FROM FILE IS _____ REQUESTED_____.
Routine: MAIN
Complex dielectric constant from file TAPE21 does not agree with data from GN and FR cards.

12. ERROR - INSUFFICIENT STORAGE FOR INTERACTION MATRICES.
IRESRV, IMAT. NEQ. NEQ2 =
Routine: FBNGF
Array storage exceeded in NGF solution.
13. ERROR - INSUFFICIENT STORAGE FOR MATRIX
Routine: FBLOCK
Array storage for matrix is not sufficient for out-of-core solution.
14. ERROR - NETWORK ARRAY DIMENSIONS TOO SMALL.
Routine: NETWK
The number of different segments to which transmission lines or network ports are connected exceeds array dimensions. Execution terminated. Array size in the original NEC deck is 30. Refer to array dimension limitations in Part II for changing array sizes.
15. ERROR - LOADING MAY NOT BE ADDED TO SEGMENTS IN N.G.F. SECTION
Routine: LOAD
See section III-5.
16. ERROR - N.G.F. IN USE. CANNOT WRITE NEW N.G.F.
Routine: MAIN
17. ERROR - NO. NEW SEGMENTS CONNECTED TO N.G.F. SEGMENTS OR PATCHES EXCEEDS LIMIT.
Routine: CONECT
Array dimension limit.
18. FAULTY DATA CARD LABEL AFTER GEOMETRY SECTION.
Routine: MAIN
A card with an unrecognizable mnemonic has been encountered in the program control cards following the geometry cards. Execution terminated.
19. GEOMETRY DATA CARD ERROR.
Routine: DATAGN
A geometry data card was expected, but the card mnemonic is not that of a geometry card. Execution terminated. After the GE card in a data deck, the possible geometry mnemonics are GE, GM, GR, GS, GW, GX, SP, and SS.
The GE card must be used to terminate the geometry cards.
20. GEOMETRY DATA ERROR - - PATCH ___ LIES IN PLANE OF SYMMETRY.
Routine: REFLC
21. GEOMETRY DATA ERROR - - SEGMENT ___ EXTENDS BELOW GROUND,
Routine: CONECT
When ground is specified on the GE card, no segment may extend below the XY plane. Execution terminated.
22. GEOMETRY DATA ERROR - - SEGMENT ___ LIES IN GROUND PLANE.
Routine: CONECT
When ground is specified on the GE card, no segment should lie in the XY plane. Execution terminated.
23. GEOMETRY DATA ERROR - - SEGMENT ___ LIES IN PLANE OF SYMMETRY.
Routine: REFLC
A segment may not lie in or cross a plane of symmetry about which the structure is reflected since the segment and its image will coincide or cross. Execution terminated.

24. IMPROPER LOAD TYPE CHOSEN, REQUESTED TYPE IS ____.
Routine: LOAD
Valid load types (LDTYP on the LD card) are from 0 through 5.
Execution terminated.
25. INCORRECT LABEL FOR A COMMENT CARD.
Routine: MAIN
The program expected a comment card, with mnemonic CM or CE, but encountered a different mnemonic. Execution terminated. Comment cards must be the first cards in a data set, and the comments must be terminated by the CE mnemonic.
26. LOADING DATA CARD ERROR, NO SEGMENT HAS AN ITAG=____.
Routine: LOAD
ITAG specified on an LD card could not be found as a segment tag.
Execution terminated.
27. NO SEGMENT HAS AN ITAG OF ____.
Routine: ISEGNO
This error results from faulty input data and can occur at any point where a tag number is used to identify a segment. Execution terminated. Tag numbers on the NT, TL, EX, CP, PQ, and PT cards should be checked.
28. NOTE, SOME OF THE ABOVE SEGMENTS HAVE BEEN LOADED TWICE, IMPEDANCES ADDED.
Routine: LOAD
A segment or segments have been loaded by two or more LD cards. The impedances of the loads have been added in series. This is only an informative message. Execution continues.
29. NUMBER OF EXCITATION CARDS EXCEEDS STORAGE ALLOTTED.
Routine: MAIN
The number of voltage source excitations exceeds array dimensions. Execution terminated. The dimensions in the original NEC deck allow 10 voltage sources. Refer to Array Dimension Limitations in Part II to change the dimensions.
30. NUMBER OF LOADING CARDS EXCEEDS STORAGE ALLOTTED.
Routine: MAIN
The number of LD cards exceeds array dimension. Execution terminated. The dimension in the original NEC deck allows 30 LD cards. Refer to Part II to change the dimensions.
31. NUMBER OF NETWORK CARDS EXCEEDS STORAGE ALLOTTED.
Routine: MAIN
The number of NT and TL cards exceeds array dimension. Execution terminated. The dimension in the original NEC deck allows 30 cards. Refer to Array Dimension Limitations in Part II to change the dimensions.
32. NUMBER OF SEGMENTS IN COUPLING CALCULATION (CP) EXCEEDS LIMIT.
Routine: MAIN
Array dimension limit.
33. NUMBER OF SEGMENTS AND SURFACE PATCHES EXCEEDS DIMENSION LIMIT.
Routine: DATAGN
The sum of the number of segments and patches is limited by dimensions. The present limit is 300.

34. PATCH DATA ERROR.
Routine: DATAGN
Invalid data on SP, SM, or SC card; or SC card not found where required.
35. PIVOT(__) = __.
Routine: FACTR (in-core) or LFACTR (out-of-core)
This will be printed during the Gauss Doolittle factoring of the interaction matrix or the network matrix when a pivot element less than 10E-10 is encountered, and indicates that the matrix is nearly singular. The number in parentheses shows on which pass through the matrix the condition occurred. This is usually an abnormal condition although execution will continue. It may result from coinciding segments or a segment of zero length.
36. RADIAL WIRE G.S. APPROXIMATION MAY NOT BE USED WITH SOMMERFELD GROUND OPTION.
Routine: MAIN
37. RECEIVING PATTERN STORAGE TOO SMALL, ARRAY TRUNCATED.
Routine: MAIN
The number of points requested in a receiving pattern exceeds array dimension. Execution will continue, but storage of normalized pattern will be truncated. This array dimension is 200 in the original NEC deck. Refer to Array Dimension Limitations in Part II to change dimension.
38. ROM2 - - STEP SIZE LIMITED AT Z =
Routine: ROM2
Probably caused by a wire too close to the ground in the Somerfeld/Norton ground method. Execution continues but results may be inaccurate.
39. SBF - SEGMENT CONNECTION ERROR FOR SEGMENT__.
Routine: SBF
The number of segments at a junction exceeds dimension limit (30), or the connection numbers are not self-consistant.
40. SEGMENT DATA ERROR.
Routine: MAIN
A segment with zero length or zero radius was found. Execution terminated.
41. STEP SIZE LIMTED AT Z=__.
Routine: INTX, HFX
The numerical integration to compute interaction matrix elements, using the Romberg variable interval width method, was limited by the minimum allowed step size. Execution will continue. An inaccuracy may occur but is usually not serious. May result from thin wire or wire close to the ground.
42. STORAGE FOR IMPEDANCE NORMALIZATION TOO SMALL, ARRAY TRUNCATED.
Routine: MAIN
The number of frequencies on FR card exceeds the array dimension for impedance normalization. An impedance beyond the limit will not be normalized. Execution continues. The limit is 50 in the original NEC deck. Refer to Array Dimension Limitations in Part II to change limit.
43. SYMMETRY ERROR - NROW, NCOL =
Routine: FBLOCK
Array overflow or program malfunction.

- 44. TBF - SEGMENT CONNECTION ERROR FOR SEGMENT __.
Routine: TBF
Same as error 39.

- 45. TRIO - SEGMENT CONNECTION ERROR FOR SEGMENT __.
Routine: TRIO
Same as error 39.

- 46. WHEN MULTIPLE FREQUENCIES ARE REQUESTED, ONLY ONE NEAR FIELD CARD CAN
BE USED - LAST CARD READ IS USED.
Routine: MAIN
Execution continues.

REFERENCES

1. Numerical electromagnetics code (NEC-1), Part I: NEC Program Description - Theory, to be publicised, Lawrence Livermore Laboratory, Livermore, CA. 1977 (content same as NOSC TD 116, Part I)
2. Numerical electromagnetics code (NEC-1), Part II: NEC Program Description - Code, to be publicised, Lawrence Livermore Laboratory, Livermore, CA. 1977 (content same as NOSC TD 116, Part II)
3. Poggio, A.J. and Adam, R. W., Approximations for Terms Related to the Kernel in Thin-Wire Integral Equations, Lawrence Livermore Laboratory, Livermore, CA. Rept. UCRL-51985, December 19, 1977
4. Albertsen, N. C., Hansen, J.E., and Jensen, N. E., Computation of Space-Lyngby, Denmark, June 1972.
5. Sengupta, D. L., Electromagnetic and Acoustic Scattering by Simple Shapes, Chapter 10, J. J. Bowman, T. B. Asenior and P. L. E. Uslenghi, Editors, North-Holland Publishing company, Amsterdam, 1969.

Contributors to the Web Edition of this Manual

I would like to thank the following for helping me put this manual on the web:

- * Charlie Panek
- * Jay A. Kralovec
- * Bruce Horn
- * Rob Farber
- * Steve Byan
- * Larry Goldstein
- * Dave Waddell
- * Deb Chatterjee
- * Rupert L. Seals
- * Doug Braun

'''

(o o)

__ooO-(_)-Ooo__

Peter D. Richeson/KA5COI Email: richesop@matrix.hv.boeing.com Home: richesop@traveller.com Phone (205)461-2603	This space for rent.
---	----------------------

 I do not speak for any one but me, and some times not even for me.

And thanks to everyone from Chuck Counselman, W1HIS, who not only speaks for no one but also accepts no blame, admits no responsibility, and deserves no credit for anything. Nonetheless he wishes to receive corrections via e-mail, as plain text and/or UUENCODEd or BinHexed "attached" binary files, including Stuffed (.sit) and/or PGP-enoded files, at <ccc@space.mit.edu>. (PGP key on servers.)