

downloaded by  
www.radioamatore.info



COMMUNICATIONS RECEIVER

**VR-120D**

**OPERATING MANUAL**



**VERTEX STANDARD CO., LTD.**

4-8-8 Nakameguro, Meguro-Ku, Tokyo 153-8644, Japan

**VERTEX STANDARD**

**US Headquarters**

17210 Edwards Rd., Cerritos, CA 90703, U.S.A.

**International Division**

8350 N.W. 52nd Terrace, Suite 201, Miami, FL 33166, U.S.A.

**YAESU EUROPE B.V.**

P.O. Box 75525, 1118 ZN Schiphol, The Netherlands

**YAESU UK LTD.**

Unit 12, Sun Valley Business Park, Winnall Close  
Winchester, Hampshire, SO23 0LB, U.K.

**VERTEX STANDARD HK LTD.**

Unit 5, 20/F., Seaview Centre, 139-141 Hoi Bun Road,  
Kwun Tong, Kowloon, Hong Kong

# Contents

---

---

<b>Introduction</b> .....	3	Changing the Channel Steps .....	16
<b>Controls &amp; Connections</b> .....	4	Preset Mode .....	17
<b>Display Icons &amp; Indicators</b> .....	5	Receiving Short-Wave Broadcast Stations .....	18
<b>Keypad Functions</b> .....	6	<b>Memory Mode</b> .....	<b>20</b>
<b>Accessories &amp; Options</b> .....	7	Memory Storage .....	20
<b>Installation of Accessories</b> .....	8	Simple Storage .....	20
Battery Installation .....	8	Designated Memory Storage .....	21
FNB-79 Battery Pack (Option) Charging .....	8	Memory Recall .....	22
Low Battery Indication .....	8	Labeling Memories .....	22
AC Operation using the optional		Memory Channel Scan .....	23
PA-30 AC Adapter .....	9	Preferential Memory Scan (PMS) .....	23
Antenna Installation .....	9	Memory Bank Scanning .....	24
Belt Clip Installation .....	9	Deleting Memory Channels .....	25
<b>Basic Operation</b> .....	<b>10</b>	Clearing of a Memory Bank .....	25
Turning the Power On/Off .....	10	<b>One-Touch Memory</b> .....	<b>26</b>
Adjusting the Volume and Squelch .....	10	<b>Channel Counter</b> .....	<b>27</b>
Band Selection .....	10	<b>Dual Watch</b> .....	<b>28</b>
Mode Selection .....	10	<b>Priority Monitoring</b> .....	<b>30</b>
Battery Saver .....	11	<b>Smart Search™</b> .....	<b>31</b>
Frequency Navigation .....	11	<b>Reset Procedures</b> .....	<b>32</b>
VFO Search .....	12	System Reset .....	32
Changing the Direction of VFO		All Reset .....	32
Search Scanning .....	12	<b>Set Mode</b> .....	<b>33</b>
How to Skip (Omit) a Frequency		<b>Cloning</b> .....	<b>40</b>
During VFO Search .....	13	<b>“AUTO” Mode Preset Operating Parameters</b> ...	<b>41</b>
Pre-Programmable Frequency Search .....	14	<b>Specifications</b> .....	<b>42</b>



The YAESU **VR-120D** is a high-performance miniature communications receiver providing general coverage reception from 100 kHz to 1299.995 MHz on the AM and FM (Wide and Narrow bandwidths) modes; this coverage includes the AM and FM broadcast bands, HF Short-wave Bands, VHF and UHF TV bands, the VHF AM aircraft band, and a wide range of commercial and public safety frequencies!

The **VR-120D**'s small size allows you to take it anywhere - hiking, skiing, or while walking around town, and its operating flexibility brings the user many avenues of operating enjoyment.

Operation of the **VR-120D** can be greatly simplified by utilizing the "PRESET" mode. The "PRESET" mode provides twelve "starting point" frequencies (one frequency in each of twelve popular listening bands), from which you may then begin manual tuning. Extensive Memory features, including special Shortwave Broadcast memories, make worldwide listening enjoyable and effortless.

We appreciate your purchase of the **VR-120D**, and encourage you to read this manual thoroughly, so as to learn about the many exciting features of your exciting new YAESU communications receiver!

# Controls & Connections

## ANTENNA Jack

Connect the supplied rubber flex antenna (or another antenna presenting a 50-Ohm impedance) here.

## VOL Knob

This control adjusts the receiver's audio volume level, and also the keypad's Beeper level. Clockwise rotation increases the audio volume level.

## SQL Knob

This control sets the threshold level at which received signals (or noise) open the "Squelch." It should be advanced clockwise just to the point where background noise is silenced, so as to provide the best sensitivity to weak signals.

## [FUNC] Key

Press and hold in this key, then press one of the keypad's buttons, to activate the "Secondary" key mode.

## DIAL Knob

This 20-position detented rotary switch is the main tuning dial for the radio. It used for most tuning, memory selection, and function-setting tasks on the radio.

## [MONI (LOCK)] Key

Press this key momentarily to "Open" the squelch manually, allowing you to listen for very weak signals. Press this key while holding in the [FUNC] key to activate the "Key Lock" Feature.

## EXT DC Jack

This coaxial DC jack allows connection to an external AC power supply.

*Note: The protective rubber cover over this jack must be pulled up to access it. Press it back over the jack when not in use, to protect the inside of the radio from dust and water.*

## [PWR] Key

Press and hold in this key for two seconds to toggle the radio's power on and off.

## KEYPAD

These 4 keys select many of the most important operating features on the VR-120D. The functions of the keys are described in detail on pages 6.

## SP Jack

This 2-conductor, 3.5-mm miniature phone jack provides audio output for an earphone. The internal loudspeaker is disabled when this jack is used.

*Note: The protective rubber cover over this jack must be pulled up to access it. Press it back*

*over the jack when not in use, to protect the inside of the radio from dust and water.*



# Display Icons & Indicators

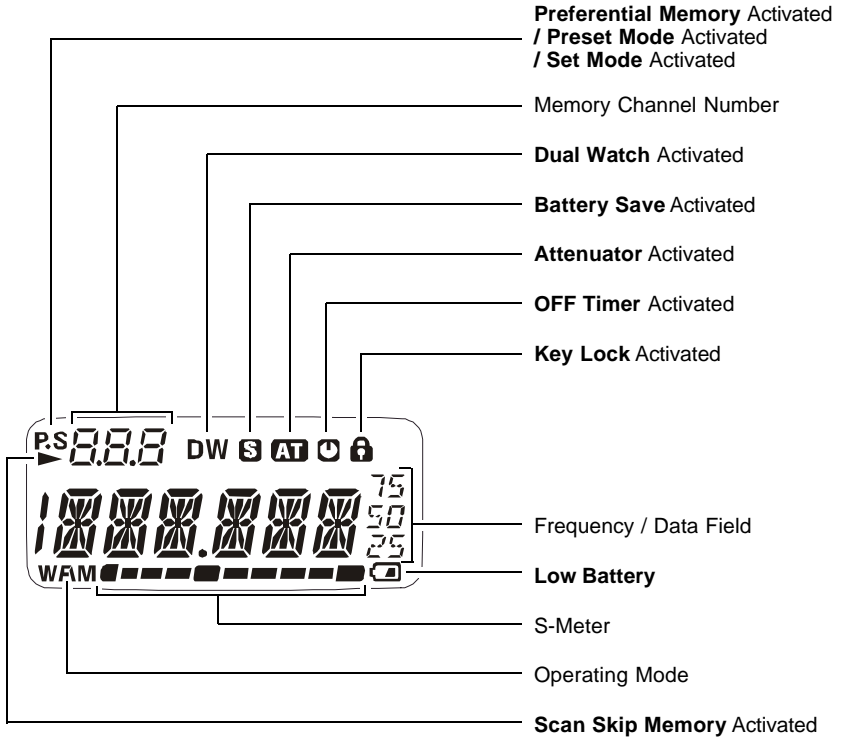

downloaded by  
[www.radioamatore.info](http://www.radioamatore.info)

# Keypad Functions

	BAND	VM	SCAN	MODE
Press Key	Selects the operating (receiving) band (toward a higher frequency band).	Selects the operating VFO Memory mode.	Starts scanning.	Selects the operating (receiving) mode, or toggles the display labels between the frequency and name tag formats.
Press [F]+	Selects the operating (receiving) band (toward a lower frequency band).	Stores the VFO frequency into a memory, or deletes the current memory channel's data. Stores the VFO frequency into a "Scan Skip" memory, or deletes the "Scan Skip" memory channel data.	Activates the "Set" (Menu) mode, or enables programming of the name tag for the current memory channel.	Engages the receiver front-end attenuator.
Press Key for 2 Seconds	Toggles the operating mode between the "Preset Mode" and the "Normal Mode."	Activates the Priority Watch and Dual Watch features.	Activates the Smart Search™ mode, or Programs and activates Preferential Memory Scan operation.	Activates the channel frequency counter mode.
Hold in [F], Press Key for 2 Seconds	Stores the Preset frequency into the memory.	Stores the frequency into the Priority memory Channel, or stores the VFO frequency pair for the Dual Watch feature into the Dual Watch Memory channel.	Stores the Scan frequency and Smart Search™ channels into the memory.	.....

downloaded by  
www.radioamatore.info

# Accessories & Options

---

## ACCESSORIES SUPPLIED WITH THE VR-120D

---



Antenna



Belt Clip

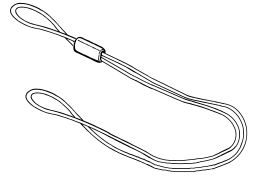

Hand Strap

- Operating Manual
- Warranty Card

---

## AVAILABLE OPTIONS FOR YOUR VR-120D

---

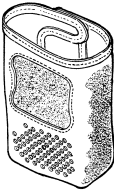

**CSC-76**  
Soft Case

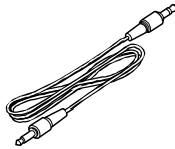

**CT-35**  
Cloning Cable

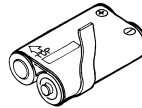

**FNB-79**  
Ni-Cd Battery Pack



**E-DC-15**  
DC Cable w/Noise  
Filter

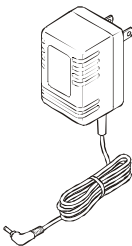

**PA-30B / C / U**  
AC Adapter

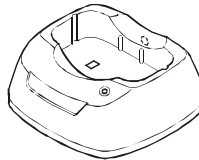

**NC-82**  
Charger Stand



**CA-34**  
Charger Sleeve

Availability of accessories may vary. Some accessories are supplied as standard per local requirements, while others may be unavailable in some regions. Consult your Yaesu Dealer for details regarding these and any newly-available options. Connection of any non-YAESU-approved accessory, should it cause damage, may void the Limited Warranty on this apparatus.

# Installation of Accessories

## BATTERY INSTALLATION

- Referring to **Figure 1**, unlock the plate by pushing the latch in the "Open" direction.
- Remove the Battery Cover from the receiver.
- Referring to **Figure 2**, insert 2 fresh AA batteries into the Battery Holder. When installing batteries, insert the (-) end first, then press in the (+) end so the battery snaps into place. Always replace two batteries at the same time.
- Referring to **Figure 3**, replace the Battery Cover, then re-lock the bottom plate by carefully pressing the hinged latch cover back into its normal operating position.

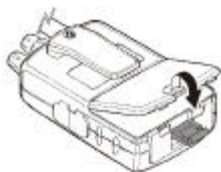

Figure 1

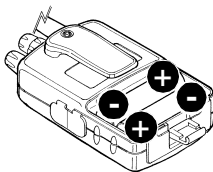

Figure 2

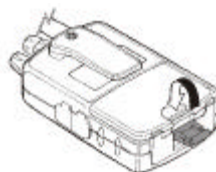

Figure 3

*Note: If you do not use the VR-120D for a long time, remove the batteries from the radio, as battery leakage could cause damage to the VR-120D.*

## FNB-79 BATTERY PACK (OPTION) CHARGING

Please see the Instruction Sheet accompanying the **FNB-79** for installation information.

- If the **FNB-79** battery pack never been used, or its charge is depleted, it may be charged by connecting the **PA-30** AC Adapter and **NC-82** Charger stand (requires **CA-34** Charger sleeve), as shown in the illustration, to the **EXT DC** jack.
- Allow a minimum of 15 hours (with **NC-82**, otherwise; 20 hours) for the **FNB-79** to reach full charge.

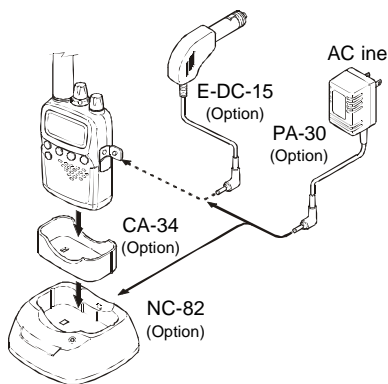

## LOW BATTERY INDICATION

When the battery voltage becomes too low, the "Battery" icon will appear in the display; indicating the batteries should be replaced. As battery voltage drops further, the **VR-120D** will shut off.

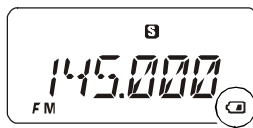

"Battery" icon



# Installation of Accessories

## AC OPERATION USING THE OPTIONAL PA-30 AC ADAPTER

The **VR-120D** may be operated from your house current by use of the optional **PA-30** AC Adapter.

To use the **PA-30**, turn the radio off, then plug the miniature connector of the AC Adapter into the **EXT DC** jack on the side of the radio. Now plug the AC Adapter into the wall outlet. You may now turn on the radio.

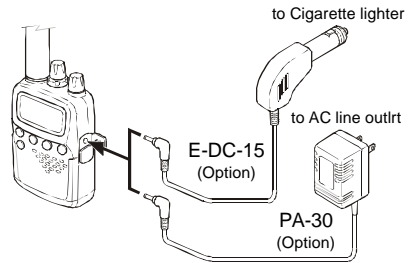

### **Important Note!!**

*Do not leave the charger connected to the Receiver for continuous periods in excess of 30 hours. Long term overcharging can degrade the Ni-Cd battery pack and significantly shorten its useful life.*

## ANTENNA INSTALLATION

- To attach the supplied antenna to the **VR-120D**, grasp the base of the antenna firmly, and exert a moderate "pinching" pressure on the base as you press the antenna onto the radio's antenna connector. While exerting this pressure, rotate the antenna clockwise 1/4 turn to lock the antenna in place.
- To remove the antenna from the **VR-120D**, grasp the base of the antenna firmly, and pinch the base of the antenna while rotating the antenna counter-clockwise 1/4 turn. You may now lift the antenna away from the radio.

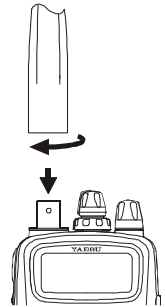

## BELT CLIP INSTALLATION

To install the Belt Clip, first place the loop of the Hand Strap into the groove at the top of the Belt Clip, and run the loop of the strap around the round mounting ridge for the Belt Clip. Now insert the mounting screw through the belt clip, and affix it snugly to the mounting hole on the back of the **VR-120D**, being careful not to allow the Hand Strap to become mis-aligned.

### **Important Note!!**

*Do not install the supplied Belt Clip Mounting Screw if you are not installing the Belt Clip! Also, do not use an improper screw for mounting the Belt Clip! An improper screw may cause a "short circuit" to the internal circuitry, causing serious damage!*

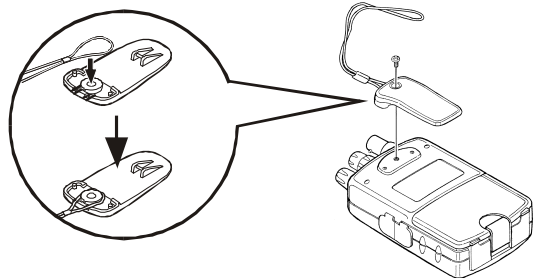

# Basic Operation

---

## TURNING THE POWER ON/OFF

---

1. Press and hold the orange [**PWR**] Key for two seconds to turn the radio on or off.
2. When you turn on the radio, a "**VR-120**" greeting message will appear on the display for two seconds. After this interval, the frequency display will appear.

---

## ADJUSTING THE VOLUME AND SQUELCH

---

1. Rotate the VOL knob to adjust the receiver's audio volume. Clockwise rotation of the VOL knob increases the volume level.
2. A The **VR-120D**'s Squelch system allows you to mute the receiver's audio output when no signals are being received. This reduces battery consumption, and reduces annoying background noise.
3. To set the squelch, turn the SQL knob fully counter-clockwise, then turn it clockwise just past the point where background noise is silenced. Do not rotate the SQL knob much beyond this threshold point; if you do, the receiver will not respond to weak signals.

---

## BAND SELECTION

---

The **VR-120D** automatically selects a default receiving band according to the frequency band on which you are operating.

If you want to change the receiving band, press the [**BND▲**] key. The receiving bands available are:

**BC band** ⇨ **SW band** ⇨ **50MHz Ham band** ⇨ **FM band** ⇨  
⇨ **AIR band** ⇨ **144MHz Ham band** ⇨ **VHF-TV band** ⇨ **ACT-1 band** ⇨  
⇨ **430MHz Ham band** ⇨ **UHF-TV band** ⇨ **ACT-2 band** ⇨  
⇨ **1200MHz Ham band** ⇨ **BC band** ⇨ **SW band** ⇨ . . .

---

## MODE SELECTION

---

The **VR-120D** automatically selects a default receiving mode according to the frequency band on which you are operating.

If you want to change the receiving mode, press the [**MODE**] key. The receiving modes available are:

**FM** ⇨ **WFM** ⇨ **AM** ⇨ **AUTO** ⇨ **FM** ⇨ . . .

---

## BATTERY SAVER

---

The **VR-120D** includes a useful "Battery Saver" feature, which significantly reduces battery consumption during operating sessions where little incoming traffic is being received. The Battery Saver "puts the radio to sleep" for a time interval programmed via the Menu; periodically, the radio will "wake up" and check briefly (250 ms.) for activity on the current operating frequency. If a station is found, full operation of the radio will resume.

To engage the Battery Saver, we use the radio's "Set" (Menu) mode, described in detail on page 34:

1. Be certain the **VR-120D** is in the "VFO" mode. Press the [**V/M**] key, if not in the VFO mode.
2. Press and hold in the [**FUNC**] key; while holding it in, press the [**SCAN**] key to activate the "Set" (Menu) mode.
3. Rotate the **DIAL** knob to select Menu #3 [SAVE].
4. Press and hold in the [**FUNC**] key; while holding it in, rotate the **DIAL** knob to select the desired "Sleep" time for the Battery Saver. The selections include 1/3/5/7/9 seconds, and "Off."
5. Press and hold in the [**FUNC**] key; while holding it in, press the [**SCAN**] key to exit to the VFO mode.

Longer "Sleep" times will reduce battery consumption. However, longer "Sleep" times also increase the possibility that you might miss a brief transmission.

---

## FREQUENCY NAVIGATION

---

Rotating the **DIAL** allows frequency tuning in steps pre-programmed at the factory. Clockwise rotation of the **DIAL** causes the radio to be tuned to toward a higher frequency, while counter-clockwise rotation will lower the operating frequency.

If you rotate the **DIAL** while pressing the [**FUNC**] key, the frequency will change in 1 MHz steps. This feature is extremely useful for making rapid frequency excursions over the wide tuning range of the radio. This step size (1 MHz) can be changed; see the "Changing the Channel Steps" section on page 15 for details.

downloaded by  
www.radioamatore.info

# Basic Operation

## VFO SEARCH

The VFO Search feature causes the radio to scan the band, looking for active frequencies.

Before initiating a VFO Search, set the Squelch so that background noise is silenced. If you are hearing background noise, the VFO Search feature will not initiate scanning.

From the VFO mode, press the [**SCAN**] key. The radio will initiate a VFO Search, tuning toward a higher frequency, and will stop when it receives a signal strong enough to break through the Squelch threshold. The radio will then hold on that frequency according to the setup of the "RESUME" mode.

To verify and/or modify the "RESUME" mode, again press the [**SCAN**] key. The current "RESUME" mode is indicated at the top of the Display (except for "Pause," which is the default setting).

The following "RESUME" modes are available:

**Pause** ⇨ **Busy** ⇨ **Hold** ⇨ **Pause** ⇨ . . .

**Pause** (Default): In this mode, the VFO search will halt on a signal it encounters, and will hold there for 5 seconds. If you do not take action to disable the VFO search within that time period, the VFO search will resume even if the station is still active.

**Busy:** In this mode, the VFO search will halt on a signal it encounters. Two seconds after the carrier has dropped because the other station(s) ceased transmission, the VFO search will resume. In this mode, the "B" icon will appear (not blinking) at the top of the display.

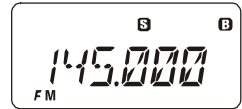

**Hold:** In this mode, the VFO search will halt on a signal it encounters. It will not restart unless you re-initiate a VFO search. In this mode, the "B" icon will blink at the top of the display.

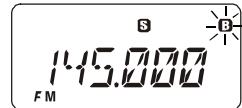

To stop the VFO search manually, just rotate the **DIAL** one click.

### Changing the Direction of VFO Search Scanning

If you wish to reverse the direction of the scan (i.e. toward a lower frequency, instead of a higher frequency), rotate the **DIAL** one click to stop the VFO search, then rotate the **DIAL** one click in the counter-clockwise direction. The VFO search direction will be reversed.

**Note:** If VFO Search has "paused" on a busy channel, it is only necessary to rotate the **DIAL** one click in the counter-clockwise direction.

To revert to VFO search toward a higher frequency once more, rotate the **DIAL** one click, then rotate it one click clockwise. If paused on a busy channel, just rotate the **DIAL** one click clockwise.

Press the [**V/M**] key to cancel the VFO search.

## How to Skip (Omit) a Frequency During VFO Search

If the VFO search stops on a frequency or frequencies that you do not need (such as a spurious radiation from a television), such frequencies can be "skipped" during VFO Search scanning. This is accomplished by storing these frequencies in a special "Frequency Skip Memory Bank" reserved for this purpose.

To skip a frequency during VFO Search scanning:

1. Press and hold in the [**FUNC**] key; while holding it in, press the [**SCAN**] key momentarily to activate the "Set"(Menu) mode.
2. Rotate the **DIAL** knob to select Menu #13 [MEMORY].
3. Press and hold in the [**FUNC**] key; while holding it in, rotate the **DIAL** knob to select "SKIP" (the VFO Skip mode).
4. Press and hold in the [**FUNC**] key; while holding it in, press the [**SCAN**] key momentarily to exit to the VFO mode.
5. Press the [**SCAN**] key to initiate scanning.
6. When VFO Search is stops on a frequency that you do not need, press the [**V/M**] key momentarily while pressing the [**FUNC**] key. The display will indicate "WRITE" as a request for command confirmation (see next step).
7. Now, press the [**V/M**] key momentarily while pressing the [**FUNC**] key again to store the frequency into the VFO Frequency Skip Memory (VFO Frequency Skip Memory Write); henceforth, it will be ignored during VFO search.
8. When you have stored all the frequencies you wish to be skipped during VFO Search scanning, return the setting of Menu #13 to "VFO" instead of "SKIP."

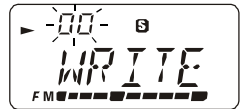

Note that the **VR-120D** has 64 VFO Frequency Skip Memory Channels (channels numbered 00 ~ 63. If your radio seems to have only 64 memories, you need to re-set Menu #13 to the "VFO" option.

To re-institute a frequency into the VFO search loop:

1. Press and hold in the [**FUNC**] key; while holding it in, press the [**SCAN**] key to activate the "Set"(Menu) mode.
2. Rotate the **DIAL** knob to select Menu #13 [MEMORY].
3. Press and hold in the [**FUNC**] key; while holding it in, rotate the **DIAL** knob to select "SKIP" (the VFO Skip mode).
4. Press and hold in the [**FUNC**] key; while holding it in, press the [**SCAN**] key momentarily to exit to the VFO mode.
5. Press the [**V/M**] key, repeatedly if necessary, to recall the VFO Frequency Skip Memory mode (an arrow plus the memory register number of the skipped frequency will appear at the left side of the display).
6. Rotate the **DIAL** knob to select the channel to be re-instituted.

# Basic Operation

7. Press the [V/M] key while pressing the [FUNC] key. The display will indicate "CLEAR" as a request for command confirmation (see next step).



8. Now, press the [V/M] key while pressing the [FUNC] key again; this action will delete the channel from the VFO Frequency Skip Memory, so as to re-institute the frequency into the VFO Search scanning loop.

## Pre-Programmed Frequency Search

The **VR-120D** allows you to program up to eight band segments within which VFO Search scanning can be limited. This allows your radio's search to be concentrated on the most active band segments in your local area, without wasting time in unused frequency segments.

To confine your search within one of the pre-programmed segments, you must first set Menu #11 ("[SEARCH]") to the "LIMIT" option, per the following procedure:

1. Press and hold in the [FUNC] key; while holding it in, press the [SCAN] key to activate the "Set"(Menu) mode.
2. Rotate the **DIAL** knob to select Menu #11 [SEARCH].
3. Press and hold in the [FUNC] key; while holding it in, rotate the **DIAL** knob to select "LIMIT" as the VFO Search mode.
4. Press and hold in the [FUNC] key; while holding it in, press the [SCAN] key to exit to the VFO mode.

The **VR-120D** has been pre-programmed at the factory with default band limits. These are grouped as "Search Band Memories" per the list below.

Search Band Memory #	Pre-Programmed Frequency Range	Search Band Memory #	Pre-Programmed Frequency Range
L00	0.5200 ~ 1.8000 MHz	L05	50.5000 ~ 54.0000 MHz
L01	1.8000 ~ 3.6000 MHz	L06	88.0000 ~ 108.0000 MHz
L02	3.6000 ~ 10.5000 MHz	L07	0.1000 ~ 1299.9950 MHz
L03	10.5000 ~ 21.0000 MHz	L - - *	0.1000 ~ 1299.9950 MHz (Default)
L04	21.0000 ~ 30.0000 MHz		

\*: You can Customize this Pre-Programmed Frequency Range (see next Page)

Here is the procedure for initiating VFO Search Scanning within one of the above bands:

1. Press the [SCAN] key; the radio will begin VFO Search Scanning (at this point, the frequency range is unimportant).As soon as scanning begins, you will notice "Lnn" appearing in the upper left hand area of the display; this indicates that you are now scanning within one of the band limits.
2. While VFO Search is active, press and hold in the [FUNC] key; while holding it in, rotate the **DIAL** knob to select the Search Band Memory as shown above. The VFO Search will now shift to the band segment within the Pre-Programmed Frequency Range associated with that memory number.

# Basic Operation

For example, while you press and hold in the **[FUNC]** key, rotate the **DIAL** knob to select Search Band Memory "L 05." After initiating VFO Search Scanning, the search will be limited to the frequency range 50.5-54.0 MHz. While VFO Search Scanning is in progress, you may change ranges by just pressing and holding in the **[FUNC]** key; while holding it in, rotate the **DIAL** knob, and the radio will jump to that range instantaneously, and will immediately begin VFO Search Scanning inside the new range.

3. Other aspects of the VFO Search feature within the pre-programmed band limits, such as the "Resume" mode, are the same as during "regular" VFO Search Scanning.
4. Press the **[V/M]** key to halt the search and return to manual tuning via the **DIAL** knob.

You can customize the Pre-Programmed Frequency Range for any of the bands shown on the previous page, so as to allow you to scan just the band segments you want.

To program the Pre-Programmed Frequency Ranges :

1. Select the frequency you want to be the Lower Frequency Limit for the Pre-Programmed Frequency Range by rotating the main tuning **DIAL**.
2. Press and hold in the **[FUNC]** key; while holding it in, press the **[SCAN]** key for 2 seconds. The display will indicate "SCH A W" briefly, then the frequency display will return.
3. Next, select the frequency you want to be the Higher Frequency Limit for the Pre-Programmed Frequency range.
4. Press and hold in the **[FUNC]** key; while holding it in, press the **[SCAN]** key for 2 seconds. The display will indicate "SCH B W."
5. Now press the **[SCAN]** key. This activates the VFO Search Scanning mode.
6. Now store this Pre-Programmed Frequency Range into one of the eight available Search Band Memories. Press and hold in the **[FUNC]** key (while you are still scanning). While holding in the **[FUNC]** key, press and hold in the **[SCAN]** key for two seconds.
7. Scanning will now have stopped. Continue to hold in the **[FUNC]** key, and rotate the **DIAL** knob to select the Search Band Memory into which you wish to store the just-programmed band limits.
8. While holding in the **[FUNC]** key, press and hold in the **[SCAN]** key for two seconds. This stores the frequency range into the designated Search Band Memory.

You can check the frequency ranges of the Search Band Memories quickly, to see if you want to re-program other ranges. To do this:

1. From the VFO mode, press the **[SCAN]** key while holding in the **[FUNC]** key to activate the "Set" (Menu) mode.
2. Rotate the **DIAL** knob to select Menu #12 [SCHMEM].
3. Rotate the **DIAL** knob while pressing the **[FUNC]** key to review the programming of the Search Band Memories. The Search Band Number (0 ~ 7) will appear at the left side of the display, while the current frequency range for that Search Band Memory will appear at the right side of the display.
4. Press the **[SCAN]** key while pressing the **[FUNC]** key to exit to normal operation.

# Basic Operation

---

## CHANGING THE CHANNEL STEPS

---

This radio's synthesizer provides the option of utilizing channel steps of 5/6.25/9/10/12.5/15/20/25/30/50/100 kHz per step, as well as an automatic step selection based on the current listening frequency ("AUTO"). Additionally, the digit of the frequency to be changed during "Fast" tuning may be selected, so as to allow rapid frequency excursions at the rate you prefer.

To change the channel steps:

1. Press the [**SCAN**] key while pressing the [**FUNC**] key to activate the "Set" (Menu) mode.
2. Rotate the **DIAL** knob to select Menu #00 [STEP].
3. Rotate the **DIAL** knob while pressing the [**FUNC**] key to select the desired frequency step size for normal tuning via the **DIAL** knob.
4. If you want to change the frequency digit which changes during "Fast" tuning, rotate the **DIAL** knob to select Menu #01 [F STEP]; press and hold in the [**FUNC**] key; while holding it in, rotate the **DIAL** knob to select the changed during fast tuning.
5. Press the [**SCAN**] key while pressing the [**FUNC**] key to save the new setting and exit to normal operation.

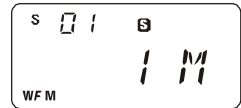
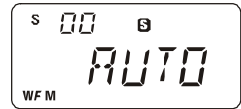

downloaded by  
[www.radioamatore.info](http://www.radioamatore.info)



## PRESET MODE

Operation of the **VR-120D** can be greatly simplified by utilizing the "PRESET" mode. The PRESET mode provides twelve "starting point" frequencies (one frequency in each of twelve popular listening bands), from which you may then begin manual tuning.

To operate in the PRESET mode:

1. Press the [**BND▲**] key for 2 seconds to change the **VR-120D** operating mode to PRESET.
2. Press the [**BND▲**] key to toggle through the following Pre-Programmed Frequencies.

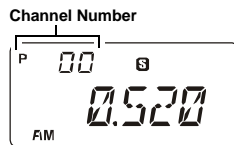

Channel Number	Pre-Programmed Frequency
0	0.520MHz (AM)
1	1.800MHz (AM)
2	3.600MHz (AM)
3	7.000MHz (AM)
4	10.500MHz (AM)
5	21.000MHz (AM)
6	50.500MHz (FM)
7	88.000MHz (WFM)
8	144.000MHz (FM)
9	430.000MHz (FM)
10	1240.000MHz (FM)
11	Weather Channels (WX-01 ~ WX-10)
12	Recalls Memory Group "0" (Memory Channels 800 - 831) Rotate the <b>DIAL</b> knob to select one of the frequencies for the stations in Memory Group 0. Press the [ <b>MODE</b> ] key to view the actual frequency. The Memory Group can be changed using Set mode #10, allowing you access to other groups of Shortwave Broadcast stations.

3. Once you have chosen a PRESET band segment, you can move off of the Pre-Programmed Frequency by rotating the **DIAL** knob. If a particular frequency is of interest to you for later use, you should store it into a Memory channel, as the Preset frequency bank resets to its original (default) value if you change banks or exit the Preset mode.
4. Press the [**BND▲**] key for 2 seconds to disable the PRESET mode and return to normal operation.

*Note: When using the PRESET mode, it isn't possible to utilize the following operations.*

- Set Mode 13 ~ Set Mode 25
- Memory Scan
- Priority Monitoring
- Memory Operation
- Channel Counter
- Smart Search
- Search Band Memory
- Dual Watch

# Basic Operation

---

## RECEIVING SHORT-WAVE BROADCAST STATIONS

---

A special bank of prominent Short-wave Broadcast stations has been pre-programmed at the factory, for quick tuning. Each station selection will have been programmed with four of its most-often used frequencies, representing both night-time frequencies (generally below 10 MHz) and day-time frequencies (generally above 10 MHz).

Of course, you are not "required" to listen just to these stations; many other stations will be found in the frequencies adjacent to those stored in the special Short-wave Broadcast Memory Bank. However, the pre-programmed stations will provide a "quick start" to your Short-wave listening enjoyment!

The frequencies of a number of broadcasting stations have been stored in the memory banks beginning with "8" and "9" (Memory Channels 800 ~ 963).

To utilize the pre-programmed Short-wave Broadcast Memory Channels (Memory Banks):

1. Press the [V/M] key to enter the Memory mode. The memory channel number will appear in the top left-hand corner of the display, indicating that you are now operating in the Memory Recall mode.

If no other memories have been programmed by you, the "VOA" broadcast station frequency bank, the first channel of which is stored on memory channel 800, is displayed in the display.

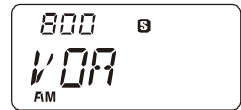

*Note: The actual operating frequency can be seen by pressing the [MODE] key. If you press it once more, the broadcast station name will again be displayed on the LCD.*

2. A Rotate the **DIAL** knob to select from the various Shortwave Broadcast stations. Because there are several frequencies available for each station, the broadcast station names will not change upon each click of the **DIAL** knob.
3. To return to the VFO mode from the Memory mode, just press the [V/M] key.

Because the shortwave broadcast stations schedule their transmissions to different areas of the world at different times of day, not all frequencies in the list will yield successful listening. Generally, frequencies below 10 MHz are better at night, while frequencies above 10 MHz are better during the day. Consult the broadcast station's schedule for current information; this may be found in a shortwave listener's magazine, or on the broadcast station's Web site.

# Basic Operation

You can change the frequencies of stations in the above frequency list, if the station's schedule and/or channel frequency should change. Here is the procedure:

1. Tune the radio to the new frequency of the Broadcast Station.
2. Press the [**V/M**] key to enter the Memory mode.
3. Rotate the **DIAL** knob to select the memory channel on which you wish to store the change.
4. Press the [**FUNC**] key, then press [**V/M**] key.

"WRITE" will appear on the display, to confirm the updating of the memory channel reflecting the new frequency.

*Note: If you perform a complete system reset of the radio's microprocessor, the frequency list will revert to the original factory-programmed configuration, as shown below.*

## Short-wave Broadcast Station List

Display	Memory Channel	Frequency (MHz)	Display	Memory Channel	Frequency (MHz)	Display	Memory Channel	Frequency (MHz)	Display	Memory Channel	Frequency (MHz)
VOA	800	6.030	ITALY	842	6.060	DENMAR	910	9.590	INDIA	942	6.045
	801	6.160		843	7.175		911	9.985		943	9.595
	802	9.760		844	9.515		912	13.800		944	11.620
	803	11.930		845	17.710		913	15.735		945	15.020
CANADA	805	5.995	BELGIU	848	5.985	NORWAY	916	7.485	CHINA	948	7.190
	806	7.235		849	9.925		917	9.590		949	5.250
	807	9.735		850	11.780		918	9.985		950	9.855
	808	11.705		851	13.740		919	13.800		951	11.685
PORTUG	816	9.780	NEDERL	853	5.955	SWEDEN	921	6.065	KOREA	952	5.975
	817	11.960		854	6.020		922	9.490		953	7.275
	818	15.555		855	9.895		923	13.625		954	9.570
	819	21.655		856	11.655		924	17.505		955	13.670
SPAIN	821	7.270	LUXEMB	858	6.090	FINLAN	926	6.120	JAPAN	956	6.155
	822	9.520		-	-		927	9.630		957	7.200
	823	11.920		-	-		928	11.755		958	9.750
	824	15.585		-	-		929	9.795		959	11.850
BBC	832	6.195	WELLE	900	3.955	RUSSIA	932	5.940	AUSTRA	960	5.995
	833	9.410		901	6.075		933	5.920		961	9.580
	834	12.095		902	9.545		934	7.205		962	9.660
	835	15.310		903	9.735		935	12.030		963	12.080
FRANCE	837	6.045	SWISS	905	3.985	ISRAEL	937	9.435	-	-	-
	838	9.790		906	6.165		938	11.585		-	-
	839	11.670		907	9.885		939	15.615		-	-
	840	15.525		908	15.220		940	17.545		-	-

# Memory Mode

The **VR-120D** provides 640 "standard" memory channels, numbered "000" through "963". Memory channels may be used to store frequencies of particular interest, for convenient recall without the need to scan through an entire operating band.

These memories are partitioned into ten Memory Banks, each holding up to 64 memory channels. The Memory Bank number is the first digit of the Memory Channel number, so Memory Channel 005 is in Memory bank "0", while Memory Channel 425 is in Memory Bank "4."

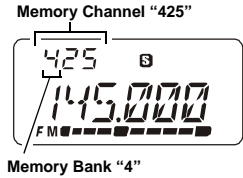

**Note:** Do not operate in the Memory Mode while Menu #13's setting is "SKIP." The "SKIP" memory bank is limited to 64 channels (total).

## MEMORY STORAGE

Two forms of memory storage are available on the **VR-120D**:

1. "Simple" memory storage automatically memorizes the desired frequency into the next-available unused memory channel register (without regard to any particular memory channel number).
2. "Designated" memory storage allows you to assign the frequency data to any desired memory channel number.

### Simple Storage

1. While operating in the VFO mode, select the desired frequency and reception mode (AM, FM, W-FM) for the station to be memorized.
2. Press and hold in the **[FUNC]** key, then press the **[V/M]** key momentarily. The microprocessor will automatically select the next-available "open" memory channel (a memory register on which no data has been stored). On the left upper side of the display, a three-digit number will appear, indicating the channel number which will be used for channel data storage. On the right side, "MW NAM" will appear ("MW" stands for "Memory Write").
3. If you wish to append an alpha-numeric label (name) to the channel, press and hold in the **[FUNC]** key, then press the **[SCAN]** key. Now skip to step (3.) of the Labeling Memories section below, and perform steps (3.) through (6.).
4. Now, press the **[V/M]** key once more while still holding in the **[FUNC]** key. This stores the frequency into the memory. "WRITE" will appear of the display, to confirm that the frequency data was successfully stored.

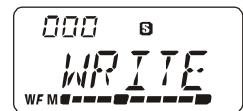
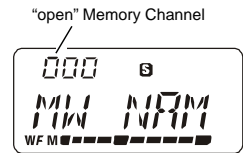

**Note:** You must press the **[V/M]** key per this step whether or not you are appending an alpha-numeric label to a memory.

## Designated Memory Storage

If you wish to store the frequency into a particular memory channel number, use the "Designated Memory" storage procedure:

*Example:* Store 162.450 MHz into Memory Channel 010, and append the label "NOA450" to the channel data:

1. While operating in the VFO mode, rotate the **DIAL** knob to select 162.450 MHz.
2. Press and hold the [**FUNC**] key; while holding it in, then press the [**V/M**] key. A channel will appear at the left upper side of the display, and "MW NAM" will appear.
3. Rotate the **DIAL** knob to select memory # 010.
4. Press the [**FUNC**] key, then press [**SCAN**]. You may now release the [**FUNC**] key.
5. You will observe a space blinking on the LCD; this indicates that you are in the alpha-numeric label entry mode.
6. Rotate the **DIAL** knob to select the "N" character.
7. Now press the [**FUNC**] key; while holding it in, rotate the **DIAL** one click clockwise to move on to the next digit. Release the [**FUNC**] key.
8. Rotate the **DIAL** knob to select the "O" character.
9. Now press the [**FUNC**] key; while holding it in, rotate the **DIAL** one click clockwise to move on to the next digit. Release the [**FUNC**] key.
10. Rotate the **DIAL** knob to select the "A" character.
11. Now press the [**FUNC**] key; while holding it in, rotate the **DIAL** one click clockwise to move on to the next digit. Release the [**FUNC**] key.
12. Rotate the **DIAL** knob to select the "4" character.
13. Now press the [**FUNC**] key; while holding it in, rotate the **DIAL** one click clockwise to move on to the next digit. Release the [**FUNC**] key.
14. Rotate the **DIAL** knob to select the "5" character.
15. Now press the [**FUNC**] key; while holding it in, rotate the **DIAL** one click clockwise to move on to the next digit. Release the [**FUNC**] key.
16. Rotate the **DIAL** knob to select the "0" character.
17. Press the [**V/M**] key while pressing the [**FUNC**] key to save the alpha-numeric information.
18. Now, press the [**V/M**] key once more while still holding in the [**FUNC**] key. This stores the frequency into the memory. "WRITE" will appear of the display, to confirm that the frequency data was successfully stored.

You still are operating in the VFO mode, and you may store other channel frequencies into other memory channel registers in the same manner. To recall these memories, proceed to the next section.

# Memory Mode

## MEMORY RECALL

Recall of memorized channels is very simple:

1. Press the **[VM]** key to enter the Memory mode. The memory number will appear in the top left-hand corner of the display, indicating that you are now operating in the Memory Recall mode.
2. Rotate the **DIAL** knob to select the desired memory channel.
3. Rotate the **DIAL** knob, while pressing the **[FUNC]** key, to recall the first memory channel of each memory bank.
4. To return to the VFO mode from the Memory mode, just press the **[VM]** key.

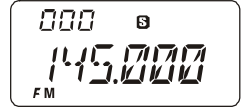

## LABELING MEMORIES

You may wish to append an alpha-numeric "Tag" (label) to a memory or memories, to aid in recollection of the channel frequency's significance (such as a Broadcast Station name, etc.). Alpha-numeric labels may be appended at the time of storage of the frequency data, or at a later time. In either case, the storage process is basically identical.

An example of alpha-numeric label programming was presented earlier in detailed form. The section to follow will summarize the process.

To label a previously-stored memory channel:

1. Recall the memory channel on which you wish to append a label.
2. Press the **[SCAN]** key while pressing the **[FUNC]** key to enable programming of the name tag. You will notice the first entry's place blink.
3. Rotate the **DIAL** to select the first digit of the desired label.  
space → A . . . Z → 0 . . . 9 → \* → + → - → / → < → > → \_ → space → A . . . Z . . .
4. Rotate the **DIAL** knob clockwise while pressing the **[FUNC]** key to move the next character. Now release the **[FUNC]** key.
5. Repeat steps (3.) to (4.) to program the remaining letters or numbers of the desired label. A total of six characters may be used in the creation of a label.
6. When you have completed the creation of the label, press the **[VM]** key, while pressing the **[FUNC]** key, to save the label.

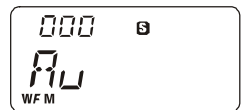
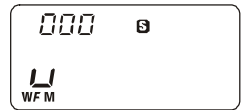

---

## MEMORY CHANNEL SCAN

---

While using the Memory mode, press the [**SCAN**] key to initiate Memory Channel Scanning. As with VFO Search, the scanner will halt on any signal encountered that is strong enough to open the squelch; it will then resume scanning according to the setting of the "RESUME" mode, described previously. Press the [**V/M**] key to halt the scan manually.

### Preferential Memory Scan (PMS)

This radio also allows you to set up a "Preferential Scan List" of channels which you can "flag" within the memory system. These channels are designated by a "PS" icon when you have selected them, one by one, for the Preferential Scan List.

*Here is the procedure for setting up the Preferential Scan List:*

1. Press the [**V/M**] key to enter the Memory mode, if you are not using memories already.
2. Rotate the **DIAL** knob to select the channel which you wish to add to the Preferential Scan List.
3. Press the [**SCAN**] key for 2 seconds. The "PS" icon will appear at the top left corner of the display, indicating that the channel is now in the Preferential Scan List.



*To remove a channel from the Preferential Scan List, repeat the above procedure: rotate the **DIAL** knob to select the channel which you wish to delete from the Preferential Scan List, then press the [**SCAN**] key for 2 seconds (the "PS" icon will disappear).*

*To initiate Preferential Memory Scan:*

1. Press the [**SCAN**] key to begin Memory Channel Scanning.
2. Once you have engaged Memory Channel Scanning, press the [**SCAN**] key for 2 seconds to initiate Preferential Memory Scanning (the "PS" icon will appear). Only the channels which have a "PS" icon appended to the channel number will now be scanned.
3. To return to normal Memory Channel Scanning, just press the [**SCAN**] key for 2 seconds (the scanner will again scan all memory channels).
4. Press the [**V/M**] key to cancel Preferential Memory Scanning.

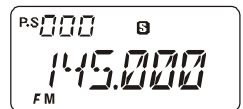

# Memory Mode

## Memory Bank Scanning

This feature allows you to scan one or more Memory Banks during Memory Channel Scanning, while ignoring other banks. For example, you may wish to load broadcast stations into certain Memory Banks for convenient recall, but ignore them during scanning (as they are always active, the scanner will halt on every such station).

To set up scanning of certain Memory Banks:

1. If you are in the Memory mode, change to the VFO mode by pressing the [V/M] key.
2. Press the [SCAN] key while pressing the [FUNC] key to activate the "Set" (Menu) mode.
3. Rotate the **DIAL** knob to select Menu #14 [SCAN].
4. Press and hold in the [FUNC] key; while holding it in, rotate the **DIAL** knob to select "BANK" as the Memory Bank mode.
5. Now rotate the **DIAL** knob to select Menu #15 [B LINK].
6. Rotate the **DIAL** knob while pressing the [FUNC] key to select the Memory Bank which you wish to include while scanning. Now release the [FUNC] key.
7. Rotate the **DIAL** knob a few clicks; you will observe an (".") icon toggling on and off below the Memory Bank number. The "." indicates that the Memory Bank is now in the Preferential Bank Scanning List.

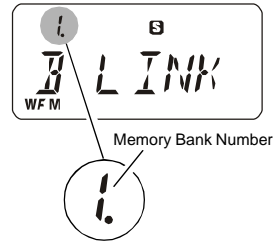

*Now again press and hold in the [FUNC] key, and rotate the **DIAL** knob to select other Memory Banks to be included in (or excluded from) the Preferential Bank Scanning List. Release the [FUNC] key, and rotate the **DIAL** knob to apply or remove the "." from the selected Memory Bank. Press the [SCAN] key while pressing the [FUNC] key when all Bank selections have been made.*

8. Again press the [SCAN] key while pressing the [FUNC] key to exit the Menu mode and return to normal operation.  
Press the [SCAN] key while pressing the [FUNC] key to exit the Menu mode and return to normal operation.
9. Press the [V/M] key to enter the Memory mode.
10. Press the [SCAN] key to initiate Memory Bank Scanning. Only the channels in the Memory Bank which have an "." below the Memory Bank number will be scanned.
11. To return to normal Memory Channel Scanning, first press the [V/M] key to return to the VFO mode, then re-enter the "Set" (Menu) mode by pressing the [SCAN] key while holding in the [FUNC] key. Rotate the **DIAL** knob to select Menu #14, and set Menu #14 to "ALL" by pressing the [FUNC] key and rotating the **DIAL** knob one click.
12. Press the [SCAN] key while pressing the [FUNC] key to exit the Menu mode.



---

## DELETING MEMORY CHANNELS

---

You may wish to delete a certain Memory Channel's data, when you no longer have a reason to recall that channel.

To delete a channel's data:

1. Recall the Memory Channel to be deleted.
2. Press the [V/M] key while pressing the [FUNC] key. You will observe "CLEAR" on the display.
3. Press the [V/M] key again, while pressing the [FUNC] key, to delete the Memory Channel.

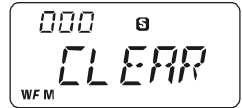

**Important Note:** Deleted Memory Channel data cannot be restored.

---

## CLEARING OF A MEMORY BANK

---

This feature allows you to clear (discard) the data from all memory channels in a desired memory bank at the same time.

1. Set the radio to the VFO mode by pressing the [V/M] key.
2. Press the [SCAN] key, while pressing the [FUNC] key, to activate the "Set" (Menu) mode.
3. Rotate the **DIAL** knob to select Menu #16 [BANKCL].
4. Rotate the **DIAL** knob one click clockwise while pressing the [FUNC] key to select the desired Memory Bank.
5. The display will now indicate "CLEAR" for about four seconds. Thereafter, clearing of the prescribed Memory Bank will be complete.
6. Press the [SCAN] key while pressing the [FUNC] key to exit to normal operation.

**Important Note:** A cleared Memory Bank can not have its channels' data restored. All data for that bank will have to be re-entered.

downloaded by  
www.radioamatore.info

# One-Touch Memory

When you activate the OTM feature, you can recall up to four favorite frequencies directly via the [BND▲], [V/M], [SCAN] and [MODE] keys. Memory channels "060," "061," "062," and "063" are assigned as "shortcuts" to the aforementioned panel keys, and data for these channels should be stored as described previously. Therefore, the [BND▲], [V/M], [SCAN] and [MODE] keys become shortcut keys which recall memory channels "060," "061," "062," and "063" for quick access to those channels.

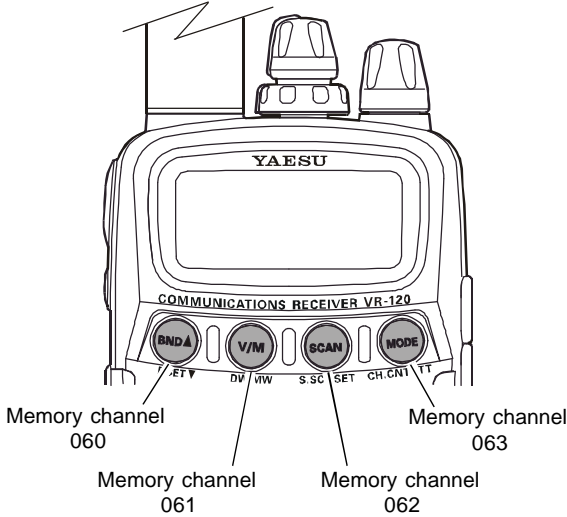

1. Set the radio to the VFO mode by pressing the [V/M] key.
2. Press the [SCAN] key while pressing the [FUNC] key to activate the "Set" (Menu) mode.
3. Rotate the DIAL knob to select Menu #24 [O T M].
4. Rotate the DIAL knob one click clockwise while pressing the [FUNC] key to select "ON."
5. Press the [SCAN] key while pressing the [FUNC] key. One touch memory now becomes operational.

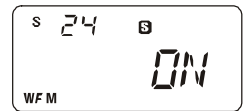

- Notes:**
- When using OTM, only the **ATT** key can be used among the operating feature keys.
  - When using OTM, it isn't possible to operate using the **DIAL**.
  - To cancel OTM, return to step (2) above, and select "OFF" when you get to Menu #24.

# Channel Counter

The Channel Counter allows measuring of the frequency of a nearby transmitter, without knowing that frequency in advance. The frequency can be measured by bringing the **VR-120D** close to the transmitter which is transmitting.

The **VR-120D** performs a high-speed search within a  $\pm 50$  MHz range from the frequency displayed on the LCD. When the strongest signal in that range is identified, the **VR-120D** displays the frequency of that (strongest) signal, and writes it into the special "channel counter memory."

*Note: This channel counter is designed to provide an indication of the operating frequency of the incoming signal, one that is close enough to allow the user to tune precisely to the other station's frequency. This feature is not, however, designed to provide a precise determination of the other station's frequency.*



1. Set the radio to the VFO mode by pressing the [V/M] key.
2. Bring **VR-120D** into close proximity to the transmitter to be measured.
3. Press the [MODE] key for 2 seconds.
  - While searching, a "count-down" display will appear (COUNT4 . . . COUNT1), and then the frequency of the nearby station will be displayed after the search ends.
  - When the channel counter is active, the antenna circuit is detached. Therefore, only stations in close proximity may have their frequencies measured using this feature.
  - When it isn't possible to determine the signal's frequency, "--NO--" will be displayed on the LCD, and the **VR-120D** will return to the VFO mode.
  - The search width of the Channel Counter can be changed via the Menu mode (item #20).
  - When the incoming signal level from the other station is extraordinarily high, you may need to increase the distance between the **VR-120D** and the other station, in order to get correct indication of the frequency.
4. Press the [V/M] key. The radio will exit from Channel Counter operation. The memory of the Channel Counter is deleted each time a new search takes place.

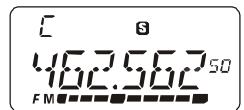

# Dual Watch

The Dual Watch feature allows you to monitor two frequencies, with the radio rapidly switching between the two channels, looking for activity. As with scanning operation, the **VR-120D** will halt when one of the channels becomes occupied by a signal strong enough to open the Squelch.

The Dual Watch system includes the option to use a bank of special memories which can store up to ten pairs of Dual Watch frequencies. These memories are pre-programmed at the factory, but can quickly be programmed by you for monitoring of your favorite frequencies on a priority basis.

To activate Dual Watch:

1. Press the [**SCAN**] key, while pressing the [**FUNC**] key, to activate the "Set" (Menu) mode.
2. Rotate the **DIAL** knob to select Menu #18 [DW/PW].
3. Press and hold in the [**FUNC**] key; while holding it in, rotate the **DIAL** knob to select "DW" as the Priority Monitoring mode.
4. Press the [**SCAN**] key, while pressing the [**FUNC**] key, to save the new setting and exit to normal operation.
5. Press and hold in the [**V/M**] key for 2 seconds. The radio will begin Dual Watch operation.
6. Once you have initiated Dual Watch operation, press and hold in the [**FUNC**] key; while holding it in, rotate the **DIAL** knob to the Dual Watch Memory as shown below. Dual Watch will cause the radio to switch back and forth (rapidly) between the Pre-Programmable Frequency pair selected (for example, if you rotate the **DIAL** knob to [A06], Dual Watch will switch every 0.5 second between 121.500 MHz and 146.940 MHz).

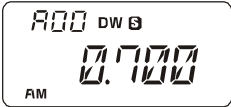
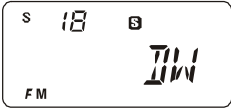

Dual Watch Memories	Pre-Programmed Frequency Pair	Dual Watch Memories	Pre-Programmed Frequency Pair
A00 b00	0.7000 AM 1.0000 AM	A05 b05	52.5250 FM 75.0000 FM
A01 b01	2.1820 AM 2.5000 AM	A06 b06	121.5000 AM 146.9400 FM
A02 b02	6.1950 AM 9.7400 AM	A07 b07	156.8000 FM 446.0000 FM
A03 b03	11.8500 AM 17.8250 AM	A - - b - -	121.5000 AM 156.8000 FM (Default)
A04 b04	21.6550 AM 29.6000 FM		

\*: You can Customize the Pre-programmed Frequency Pair.

7. Dual Watch will halt when the **VR-120D** receives a signal strong enough to break through the Squelch threshold. The radio will then hold on that frequency according to the setting of the "RESUME" mode, described previously.
8. To stop Dual Watch manually, just rotate the **DIAL** knob one click. If you like, you can then tune manually back and forth between the two Dual Watch memories by rotating the **DIAL** knob.
9. Press the [**V/M**] key to cancel Dual Watch operation and return to the previous operating mode (VFO or Memory).

You can change any or all of the Dual Watch pre-programmed frequency pairs in accordance with your operating preferences.

To program a Dual Watch Memory frequency pair:

1. Press the [**SCAN**] key, while pressing the [**FUNC**] key, to activate the "Set" (Menu) mode.
2. Rotate the **DIAL** knob to select Menu #18 [DW/PW].
3. Press and hold in the [**FUNC**] key; while holding it in, rotate the **DIAL** knob to select "DW" as the Priority Monitoring mode.
4. Press the [**SCAN**] key while pressing the [**FUNC**] key to save the new setting and exit to normal operation.
5. Select one of the frequencies you wish to utilize for Dual Watch, using the main **DIAL**.
6. Press and hold in the [**V/M**] key for 2 seconds while pressing the [**FUNC**] key. "DWA W" (Dual Watch Channel "A") will appear on the display.
7. Now select the second frequency you wish to utilize for Dual Watch.
8. Press and hold in the [**V/M**] key for 2 seconds while pressing the [**FUNC**] key. "DWB W" (Dual Watch Channel "B") will appear on the display.
9. Press and hold in the [**V/M**] key for 2 seconds to activate Dual Watch between the above frequency pair.
10. Press and hold in the [**V/M**] key for 2 seconds while pressing the [**FUNC**] key.
11. Now, store this frequency pair into one of the eight available Dual Watch Memory registers. Just press and hold in the [**FUNC**] key; while holding it in, rotate the **DIAL** knob to the Dual Watch Memory register into which you want to store this frequency pair.
12. Press and hold in the [**V/M**] key for 2 seconds while pressing the [**FUNC**] key.

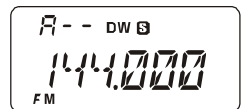
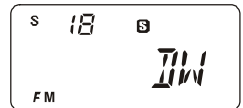

# Priority Monitoring

The "Priority" feature, which is somewhat similar to Dual Watch, allows you to monitor a VFO frequency while checking a "Priority Memory" channel every five seconds for activity. If the Priority Memory channel becomes active with a signal strong enough to open the Squelch, the radio will halt on that frequency and will hold there in accordance with the setting of the "RESUME" mode, described previously.

To set up Priority Monitoring:

1. Press the [**SCAN**] key, while pressing the [**FUNC**] key, to activate the "Set" (Menu) mode.
2. Rotate the **DIAL** knob to select Menu #18 [DW/PW].
3. Press and hold in the [**FUNC**] key; while holding it in, rotate the **DIAL** knob to select "PW" as the Priority Monitoring mode.
4. Press the [**SCAN**] key while pressing the [**FUNC**] key to save the new setting and exit to normal operation.
5. Select the frequency you wish to be the "Priority" frequency, using the main **DIAL**.
6. Press and hold in the [**V/M**] key for 2 seconds, while holding in the [**FUNC**] key, to store the frequency into the Priority Memory Channel.
7. Select the desired "main monitoring" frequency on the VFO.
8. Press and hold in the [**V/M**] key for 2 seconds to activate Priority Channel monitoring. "P" and "DW" will appear in the display and "Priority" will be activated. If activity appears on the Priority Memory, the radio will hold on that frequency per the programming of the "RESUME" mode.
9. Press the [**V/M**] key to cancel Priority Monitoring operation.

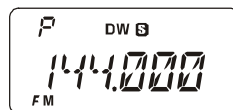
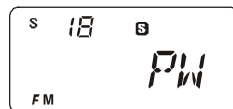

downloaded by  
www.radioamatore.info

The Smart Search™ feature allows you to load frequencies automatically according to where activity is encountered by your radio. This feature is especially helpful when visiting a new city, where you may not know the frequencies of active stations. The **VR-120D** includes a special 21-channel Smart Search™ Memory Bank which is separate from the main memory system.

To set up Smart Search™ operation:

1. Set the radio to the VFO mode by pressing the [**V/M**] key, if necessary.
2. Tune the radio to the frequency you wish to use as the lower frequency limit for the Smart Search™ sweep.
3. Press and hold in the [**SCAN**] key for 2 seconds ("S-" will be shown in the top of the display; this means that Smart Search™ is enabled), then rotate the **DIAL** knob one click clockwise to select the Smart Search™ "SL" memory. If you have stored a frequency into the "SL" memory already, its frequency will be displayed.)
4. Press and hold in the [**SCAN**] key for 2 seconds while pressing the [**FUNC**] key. This stores the lower frequency limit into the Smart Search™ "SL" memory ("LOW W" will appear on the display).
5. Now tune the radio to the frequency you wish to use as the starting frequency for the Smart Search™ sweep. This frequency must be different from the upper and lower limits.
6. Press and hold in the [**SCAN**] key for 2 seconds ("S-" will be shown in the top of the display; this means that Smart Search™ is enabled), then rotate the **DIAL** knob two clicks clockwise to select the Smart Search™ "SS" memory. If you have stored a frequency into the "SS" memory already, its frequency will be displayed.
7. Press and hold in the [**SCAN**] key for 2 seconds while pressing the [**FUNC**] key. This stores the lower frequency limit into the Smart Search™ "SS" memory ("ST W" will appear on the display).
8. Tune the radio to the frequency you wish to use as the upper frequency limit for the Smart Search™ sweep.
9. Press and hold in the [**SCAN**] key for 2 seconds ("S-" will be shown in the top of the display; this means that Smart Search™ is enabled), then rotate the **DIAL** knob three clicks clockwise to select the Smart Search™ "SU" memory. If you have stored a frequency into the "SU" memory already, its frequency will be displayed.
10. Press and hold in the [**SCAN**] key for 2 seconds while pressing the [**FUNC**] key. This stores the upper frequency limit into the Smart Search™ "SU" memory ("UP W" will appear on the display).

To initiate Smart Search operation:

1. Be sure that the SQL control is set such that the background noise is silenced.
2. Press and hold in the [**SCAN**] key for 2 seconds to enter the Smart Search™ mode, then again press and hold in the [**SCAN**] key for 2 seconds. Smart Search™ scanning will now begin. All channels where activity is present (up to 10 in each direction) will be loaded into the Smart Search™ memories. Whether or not all 21 memories are filled, the Smart Search™ scan will stop after one sweep in each direction.
3. Now you can turn the **DIAL** to select the Smart Search™ memories.
4. To disable Smart Search™ operation, press the [**V/M**] key.

# Reset Procedures

---

Occasionally, a static discharge or other anomaly will cause the microprocessor to go into erratic behavior. This can frequently be corrected by a "System Reset" whereby the microprocessor is cleared of all "soft" data. If you just want to clear the Menu and Function Mode settings to their factory defaults, without losing your frequency memories, use the "Function/Menu Reset" procedure.

---

## SYSTEM RESET

---

(To reset the Function mode and Set (Menu) mode settings to their factory defaults)

1. Turn the radio off.
  2. Press and hold in the [**FUNC**] and [**MONI**] keys while turning the radio on (press the [**V/M**] key at this time to cancel the Reset procedure).
  3. Press the [**V/M**] key, while pressing the [**FUNC**] key, to reset the all settings to their factory defaults.
- 

## ALL RESET

---

(To clear all memories and other settings to factory defaults)

1. Turn the radio off.
2. Press and hold the [**FUNC**], [**MONI**] and [**BND▲**] keys while turning the radio on (press the [**V/M**] key at this time to cancel the Reset procedure).
3. Press the [**V/M**] key, while pressing the [**FUNC**] key, to reset the all settings to their factory defaults.

downloaded by  
[www.radioamatore.info](http://www.radioamatore.info)



The **VR-120D** "Set" mode is an easy-to-use Menu system, which allows customization of many **VR-120D** configuration parameters.

Use the following "generic" procedure to engage the "Set" (Menu) mode:

1. Set the radio to the VFO mode by pressing the [**V/M**] key.  
You cannot access the Menu while in the Memory mode.
2. Press the [**SCAN**] key, while pressing the [**FUNC**] key, to activate the "Set" (Menu) mode.  
The Menu Item number and a brief title for the Menu Item will appear on the display.
3. Rotate the **DIAL** knob to select the Menu Item you wish to work on.
4. Rotate the **DIAL** knob, while pressing the [**FUNC**] key, to change the value or condition for the selected Menu Item.
5. Press the [**SCAN**] key, while pressing the [**FUNC**] key, to save the new setting and exit to normal operation.

Menu item	Function	Default	
00	STEP	Channel Steps	AUTO
01	F STEP	Selects the desired "Fast" Channel Steps	1 MHz
02	LAMP	Selects the LCD Lamp Mode	AUTO
03	SAVE	Selects the Battery Save Interval ("sleep" ratio)	1 sec (1:4)
04	OFFTIM	Sets the "Sleep Timer" Time	OFF
05	PAUSE	Sets the Delay time for scanning	5 sec
06	BEEP	Enables/Disables the Keypad Beeper	ON
07	VOLT	Checks Battery Voltage (1.9 ~ 3.5 V)	-
08	SM SEN	The setting of S-meter sensitivity	NORMAL
09	SM BUZ	Enable/Disables the S-Meter Buzzer	OFF
10	GROUP	Selects the Preset Mode (# P12)	GROUP0
11	SEARCH	Selects the VFO Scan Type	VFO
12	SCHMEM	Displays the "Search Band" Memory frequency pair	-
13	MEMORY	Selects Memory Channel operation mode between the "regular" memories (VFO) or "skipped" memory (SKIP).	VFO
14	SCAN	Enables/Disables Memory Bank Scanning	ALL
15	B LINK	Sets up the Bank Link Feature	-
16	BANKCL	Clears (masks) all the Memory Channels in a particular Memory Bank.	-
17	SKIPCL	Clears all Memory Channels in "Skip" Memory	-
18	DW/PW	Dual Watch / Priority Monitoring	DW
19	S SCH	Selects the Smart Search operating mode	SINGLE
20	CH CNT	Channel Counter Search Width	±50 MHz
21	FLEX S	Enables/Disables the "flexible" frequency step feature	ON
22	AM ANT	Selection of the antenna used in the AM mode	EXT
23	FM ANT	Selection of the antenna used in the FM mode	EXT
24	O T M	Activation of One touch Memory	OFF
25	GAME	This VR-120D includes a simple "slot machine" game in which three digits scroll in a random fashion.	-

# Set Mode

---

## Set Item 00 [STEP]

**Function:** Channel Steps  
**Available Values:** AUTO / 5 / 6.25 / 9 / 10 / 12.5 / 15 / 20 / 25 / 30 / 50 / 100 kHz  
**Default:** AUTO

## Set Item 01 [F STEP]

**Function:** Selects the desired "Fast" Channel Steps  
**Available Values:** 10 k / 100 k / 1M / 10 M / 100 MHz  
**Default:** 1 MHz

## Set Item 02 [LAMP]

**Function:** Selects the LCD Lamp Mode  
**Available Values:** AUTO / ON / OFF  
**AUTO:** Illuminates the LCD/Keypad lamp for 5 seconds when any key is pressed.  
**ON:** Pressing the LAMP key toggles LCD/Keypad lamp On/Off.  
**OFF:** Disables the LCD/Keypad lamp.  
**Default:** AUTO

## Set Item 03 [SAVE]

**Function:** Selects the Battery Save Interval ("sleep" ratio)  
**Available Values:** OFF / 1:4 (1 sec) / 1:12 (3 sec) / 1:20 (5 sec) / 1:28 (7 sec) / 1:36 (9 sec)  
**Default:** 1:4 (1 sec)

The **VR-120D** will be turned off for the interval programmed via this Menu item, then it will check the current frequency for 250 ms, looking for activity.

## Set Item 04 [OFFTIM]

**Function:** Sets the "Sleep Timer" Time  
**Available Values:** OFF / 30 / 60 / 90 min.  
**Default:** OFF

## Set Item 05 [PAUSE]

**Function:** Sets the Delay time for scanning  
**Available Values:** 1sec ~ 12sec  
**Default:** 5 sec

This Menu Item defines the length of time the scanner will hold on a frequency.

## **Set Item 06 [BEEP]**

**Function:** Enables/Disables the Keypad Beeper

**Available Values:** ON/OFF

**Default:** ON

## **Set Item 07 [VOLT]**

**Function:** Checks Battery Voltage (1.9 ~ 3.5 V)

## **Set Item 08 [SM SEN]**

**Function:** The setting of S-meter sensitivity

**Available Values:** NORMAL / LOW (FM only)

NORMAL: Makes the sensitivity of the S meter "Normal."

LOW: Lowers the sensitivity of the S meter. (FM only)

**Default:** NORMAL

## **Set Item 09 [SM BUZ]**

**Function:** Enables/Disables the S-Meter Beeper; when the Beeper is engaged, the moving S-meter is disabled.

**Available Values:** OFF/BUZZER

**Default:** OFF

## **Set Item 10 [GROUP]**

**Function:** Selects the Preset Mode's Memory Group for Preset Channel 12

**Available Values:** GROUP0 / GROUP1 / GROUP2 / GROUP3  
/ GRPEX0 / GRPEX 1 / GRPEX2 / GRPEX3 / GRPEX4  
/ GRPEX5 / GRPEX6 / GRPEX7

GROUP0: Memory Channel 800 ~ 831

GROUP1: Memory Channel 832 ~ 863

GROUP2: Memory Channel 900 ~ 931

GROUP3: Memory Channel 932 ~ 963

GRPEX0: Memory Channel 800 ~ 815

GRPEX1: Memory Channel 816 ~ 831

GRPEX2: Memory Channel 832 ~ 847

GRPEX3: Memory Channel 848 ~ 863

GRPEX4: Memory Channel 900 ~ 915

GRPEX5: Memory Channel 916 ~ 931

GRPEX6: Memory Channel 932 ~ 947

GRPEX7: Memory Channel 948 ~ 963

**Default:** GROUP0

# Set Mode

---

## Set Item 11 [SEARCH]

- Function:** Selects the VFO Scan Type
- Available Values:** VFO/LIMIT
- VFO: The VFO scanner scans frequencies between the 0.1 MHz and 1300 MHz.
- LIMIT: The VFO scanner scans frequencies between the pre-programmed frequency limits.
- Default:** VFO

## Set Item 12 [SCHMEM]

- Function:** Displays the "Search Band" Memory frequency pair
1. Recall Set Item 12, then rotate the **DIAL** knob while pressing the [**FUNC**] key.
  2. As you rotate the **DIAL** knob, the nine numbered "Search Band Memory" numbers will be displayed, along with the frequencies contained in those memories.
  3. Press the [**SCAN**] key while pressing the [**FUNC**] key to return to the Menu item selection mode.

## Set Item 13 [MEMORY]

- Function:** Selects Memory Channel operation mode between the "regular" memories (VFO) or "skipped" memory (SKIP).
- Available Values:** VFO / SKIP
- Default:** VFO
- Important Note:* If not specifically working with the "Skipped" memories, this Menu Item should be set to "VFO." The "regular" memories are not available for use in the "SKIP" mode.

## Set Item 14 [SCAN]

- Function:** Enables / Disables Memory Bank Scanning
- Available Values:** ALL / BANK
- ALL: Enables Memory Bank (only) Scanning
- BANK: Disables Memory Bank Scanning
- Default:** ALL

## Set Item 15 [B LINK]

- Function:** Sets up the Bank Link Feature

## Set Item 16 [BANKCL]

- Function:** Clears (masks) all the Memory Channels in a particular Memory Bank.
1. After selecting Set Item 16, rotate the **DIAL** knob while pressing the [**FUNC**] key to select the Memory Bank number. The display will indicate "CLEAR" as a request for command confirmation.
  2. Press the [**SCAN**] key, while pressing the [**FUNC**] key, to return to the Menu item selection mode.

## Set Item 17 [SKIPCL]

- Function:** Clears all Memory Channels in "Skip" Memory
1. After selecting Set Item 17, rotate the **DIAL** knob one click clockwise while pressing the [**FUNC**] key to Skip Memory. The display will indicate "CLEAR" as a request for command confirmation.
  2. Press the [**V/M**] key while pressing the [**FUNC**] key again; this action will clear all the "Skip" Memories.

## Set Item 18 [DW/PW]

**Function:** Dual Watch / Priority Monitoring

**Available Values:** DW / PW

DW: The Dual Watch feature allows you to monitor two frequencies.

PW: The "Priority" feature, which is somewhat similar to Dual Watch, allows you to monitor a VFO frequency while checking a "Priority Memory" channel every five seconds for activity.

**Default:** DW

## Set Item 19 [S SCH]

**Function:** Selects the Smart Search™ operating mode

**Available Values:** SINGLE/CONTINUE

SINGLE: The **VR-120D** sweeps once in each direction starting on the current frequency. All channels where activity is present are loaded into the Smart Search™ memories. Whether or not all memories are filled, the search stops after one sweep in each direction.

CONTINUE: The **VR-120D** makes a sweep in each direction as with the "SINGLE" mode, but if all channels not filled after the first sweep, the **VR-120D** continues sweeping until they are all filled.

**Default:** SINGLE

# Set Mode

---

## Set Item 20 [CH CNT]

**Function:** Channel Counter Search Width  
**Available Values:**  $\pm 5 / \pm 10 / \pm 50 / \pm 100$  MHz  
**Default:**  $\pm 50$  MHz

## Set Item 21 [FLEX S]

**Function:** Enables/Disables the "flexible" frequency step feature  
**Available Values:** ON/OFF  
OFF: When you change the receive mode, the channel steps remain the same.  
ON: When you change the receive mode, the VFO frequency will increment according to the current receive mode.  
**Default:** ON

## Set Item 22 [AM ANT]

**Function:** Selection of the antenna used in the AM mode  
**Available Values:** EXT/BAR  
EXT: Selects the rubber flex Antenna  
BAR: Selects the internal Bar Antenna.  
The Bar antenna is directional; rotate the **VR-120D** for best reception.  
**Default:** EXT

## Set Item 23 [FM ANT]

**Function:** Selection of the antenna used in the FM mode  
**Available Values:** EXT /EARPHO  
EXT: Selects the rubber flex Antenna  
EARPHO: Selects the Earphone Antenna. When receiving a weak signal, reception may be noisy.  
**Default:** EXT

## Set Item 24 [O T M]

**Function:** Activation of One touch Memory  
**Available Values:** OFF /ON  
OFF: One Touch Memory is disabled.  
ON: The [**BND▲**], [**V/M**], [**SCAN**] and [**MODE**] function as One-Touch Memory Recall keys.  
**Default:** OFF

---

## Set Item 25 [GAME]

### **Function:**

This **VR-120D** includes a simple "slot machine" game in which three digits scroll in a random fashion. You manually stop each digit in sequence, with the object being to get all three numbers to match.

1. After selecting Set Item 25, rotate the **DIAL** knob one click clockwise while pressing the **[FUNC]** key to engage the game mode. The display will indicate "READY" as a request for command confirmation.
2. Press the **[BND▲]** key to start the slot machine game. Three digits will scroll in in random fashion on the display.
3. Press the **[V/M]** key to stop the left digit.
4. Next, press the **[SCAN]** key to stop the center digit.
5. Finally, press the **[MODE]** key to stop the right digit.
6. If all three digits match, digits (such as 777, 555, 333, etc.) you win! Regrettably, no cash prizes are available in this mode!
7. If you wish to play again, press the **[BND▲]** key.

downloaded by  
[www.radioamatore.info](http://www.radioamatore.info)

# Cloning

The **VR-120D** includes a convenient "Clone" feature, which allows the memory and configuration data from one radio to be transferred to another **VR-120D**. Here is the procedure for Cloning one radio's data to another:

1. Turn both radios off.
2. Connect the optional **CT-35** cloning cable between the SP jacks of the two radios.
3. Press and hold in the [**FUNC**] and [**BAD▲**] keys while turning the radio on. Do this for both radios (the order of the switch-on does not matter).
4. On the *Destination* radio, press the [**SCAN**] key.
5. Now, on the *Source* radio, press the [**MODE**] key.  
*If there is a problem during the cloning process, "ERROR" or "WAR" will be displayed. Check your cable connections and battery voltage, and try again.*
6. If the data transfer is successful, "PASS" will appear on the displays of both radios. Press any key to exit to normal operation.
7. Turn both radios off and disconnect the **CT-35**.

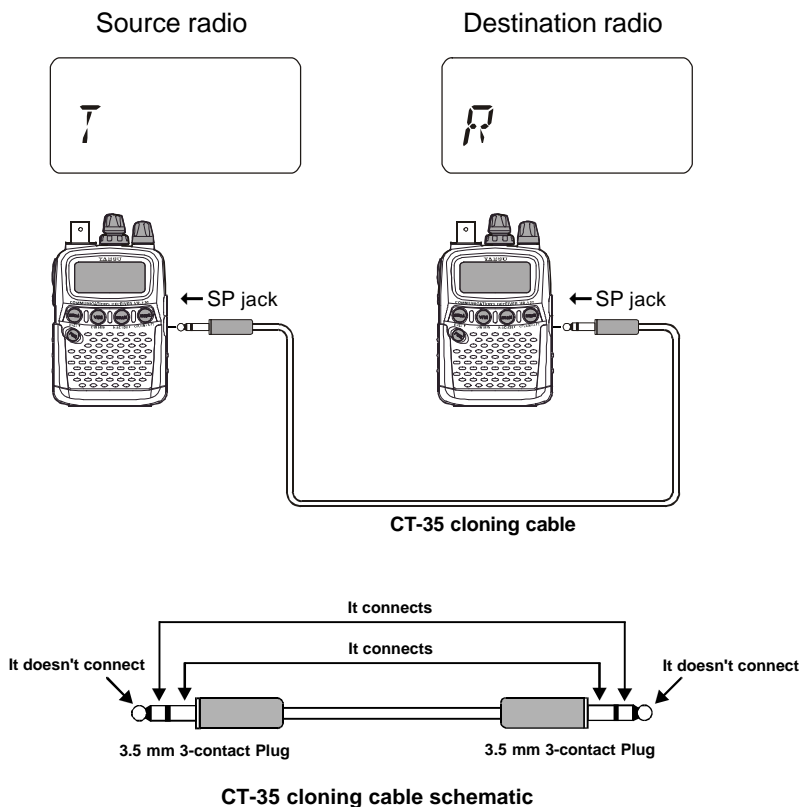



# “AUTO” Mode Preset Operating Parameters

Frequency Range (MHz)	MODE	STEP (kHz)	Frequency Range (MHz)	MODE	STEP (kHz)
0.1000 ~ 0.2850	FM	5	162.9000 ~ 174.0000	FM	12.5
0.2850 ~ 0.5200	AM	5	174.0000 ~ 216.0000	WFM	50
0.5200 ~ 1.7100	AM	10	216.0000 ~ 225.0000	FM	5
1.7100 ~ 50.5000	FM	5	225.0000 ~ 262.0000	AM	100
50.5000 ~ 54.0000	FM	5	262.0000 ~ 270.0000	FM	12.5
54.0000 ~ 108.0000	WFM	50	270.0000 ~ 271.0000	AM	100
108.0000 ~ 142.0000	AM	25	271.0000 ~ 275.0000	FM	12.5
142.0000 ~ 144.0000	FM	12.5	275.0000 ~ 336.0000	AM	100
144.0000 ~ 148.0000	FM	5	336.0000 ~ 420.0000	FM	12.5
148.0000 ~ 156.0000	FM	12.5	420.0000 ~ 450.0000	FM	25
156.0000 ~ 157.4500	FM	25	450.0000 ~ 470.0000	FM	12.5
157.4500 ~ 160.6000	FM	12.5	470.0000 ~ 770.0000	WFM	50
160.6000 ~ 160.9750	FM	25	770.0000 ~ 1240.0000	FM	25
160.975 ~ 161.50000	FM	12.5	1240.0000 ~ 1300.0000	FM	25
161.5000 ~ 162.9000	FM	25	-	-	-

downloaded by  
www.radioamatore.info

# Specifications

---

<b>Frequency Range:</b>	100 kHz ~ 1299.995 MHz (Cellular Blocked)
<b>Receiving Mode:</b>	AM/FM/WFM
<b>Circuit Type:</b>	Triple Super-heterodyne
<b>Memory Channels:</b>	640 Channels
<b>Memory Bank:</b>	10 Banks (@ 64 Channels)
<b>Antenna Impedance:</b>	50-ohm unbalanced, BNC receptacle
<b>Intermediate Frequencies:</b>	248.45 MHz, 15 MHz, 450 kHz
<b>Sensitivity (Typical):</b>	200kHz ~ 5 MHz: AM 3.5 dB $\mu$ (1.5 $\mu$ V) 5 ~ 160 MHz: AM -4.4 dB $\mu$ (0.6 $\mu$ V) FM -10.4 dB $\mu$ (0.3 $\mu$ V) WFM -1.0 dB $\mu$ (0.9 $\mu$ V) 160 ~ 370 MHz: AM -4.4 dB $\mu$ (0.6 $\mu$ V) FM -10.4 dB $\mu$ (0.3 $\mu$ V) WFM -4.4 dB $\mu$ (0.6 $\mu$ V) 370 ~ 520 MHz: FM -10.4 dB $\mu$ (0.3 $\mu$ V) WFM 0 dB $\mu$ (1.0 $\mu$ V) 520 ~ 1300 MHz: FM -3.0 dB $\mu$ (0.7 $\mu$ V) WFM 9.5 dB $\mu$ (3.0 $\mu$ V)
<b>Selectivity:</b>	WFM: 200 kHz/-6 dB AM/FM: 16 kHz/-6 dB
<b>Conducted Spurious Emission:</b>	Less than -54 dBm
<b>Supply Voltage:</b>	2.2 ~ 3.5 V DC; Internal Battery (Nominal: 3.0 V DC) 5.5 ~ 10.0 V DC (EXT DC)
<b>Current Consumption:</b>	Approx. 95 mA (Receive, AF Output 50 mW, 8-ohm) Approx. 15 mA (Standby, Saver 1:4 on) Approx. 55 mA (Standby, Saver off)
<b>Operating Temp.:</b>	-10 °C ~ +50 °C
<b>AF Output:</b>	Approx. 80 mW (8-ohm)
<b>Case Size:</b>	85 x 59 x 26 mm (H x W x D) w/o knob
<b>Weight:</b>	Approx. 195 g w/battery & antenna

*Specifications are subject to change without notice.*

downloaded by  
[www.radioamatore.info](http://www.radioamatore.info)

1. Changes or modifications to this device not expressly approved by VERTEX STANDARD could void the user's authorization to operate this device.
2. This device complies with part 15 of the FCC Rules. Operation is subject to the following two conditions; (1) this device may not cause harmful interference, and (2) this device must accept any interference including interference that may cause undesired operation.
3. The scanning receiver in this equipment is incapable of tuning, or readily being altered, by the User to operate within the frequency bands allocated to the Domestic public Cellular Telecommunications Service in Part 22.

This device complies with RSS-210 of Industry Canada. Operation is subject to the following two conditions: (1) this device may not cause interference; and (2) this device must accept any interference, including interference that may cause undesirable operation of this device.



downloaded by  
[www.radioamatore.info](http://www.radioamatore.info)

Copyright 2001  
VERTEX STANDARD CO., LTD.  
All rights reserved.

No portion of this manual  
may be reproduced  
without the permission of  
VERTEX STANDARD CO., LTD.

Printed in Japan

0112J-0Y

