

KENWOOD

INSTRUCTION MANUAL

144/440 MHz FM DUAL BANDER

TM-G707A

144/430 MHz FM DUAL BANDER

TM-G707A

144/430 MHz FM DUAL BANDER

TM-G707E

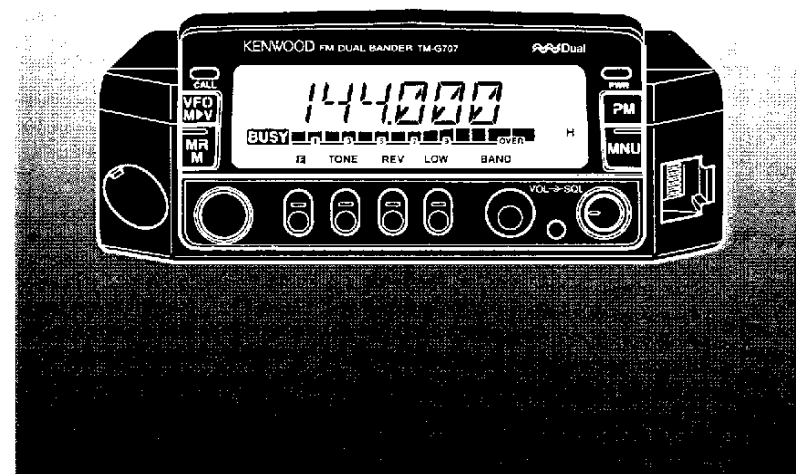

KENWOOD CORPORATION

© B62-0864-00 (K,E,M)
09 08 07 06 05 04 03 02 01 00

Downloaded by
RadioAmateur.EU

THANK YOU!

We are grateful you decided to purchase this **KENWOOD** FM transceiver. This series of mobile transceivers were developed to satisfy the requirement for a compact rig that's simple to operate yet contains numerous sophisticated features. The dual band operation will be appreciated by hams who want access to VHF and UHF bands with a transceiver smaller than some single banders.

KENWOOD believes that the compact size, coupled with the reasonable cost, will meet your satisfaction.

MODELS COVERED BY THIS MANUAL

The models listed below are covered by this manual.

TM-G707A: 144/440 MHz FM Dual Bander
(U.S.A./ Canada)

TM-G707A: 144/430 MHz FM Dual Bander
(General market)

TM-G707E: 144/430 MHz FM Dual Bander
(Europe)

FEATURES

This transceiver has the following main features.

- Enhanced Programmable Memory (PM) channels store virtually entire current operating environments for your quick recall.
- Contains a total of 180 memory channels programmable with separate receive and transmit frequencies as well as simplex frequencies, and other various data.
- Allows each memory channel to be named using up to 7 alphanumeric characters; you may assign a name such as a callsign or repeater name.
- Provides Easy Operation mode for hams who want to use only the basic functions for now.
- If programmed, the built-in Continuous Tone Coded Squelch System (CTCSS) rejects unwanted calls from other persons who are using the same frequency.
- Equipped with an easy-to-read large LCD with alpha-numeric display capability.
- The compact front panel is detachable from the main unit. If used with an optional front panel kit, the separated panel can be mounted in a convenient different place.
- The dedicated DATA connector is available for 1200 bps or 9600 bps Packet Operation.

NOTICES TO THE USER

One or more of the following statements may be applicable:

FCC WARNING

This equipment generates or uses radio frequency energy. Changes or modifications to this equipment may cause harmful interference unless the modifications are expressly approved in the instruction manual. The user could lose the authority to operate this equipment if an unauthorized change or modification is made.

INFORMATION TO THE DIGITAL DEVICE USER REQUIRED BY THE FCC

This equipment has been tested and found to comply with the limits for a Class B digital device, pursuant to Part 15 of the FCC Rules. These limits are designed to provide reasonable protection against harmful interference in a residential installation.

This equipment generates, uses and can generate radio frequency energy and, if not installed and used in accordance with the instructions, may cause harmful interference to radio communications. However, there is no guarantee that the interference will not occur in a particular installation. If this equipment does cause harmful interference to radio or television reception, which can be determined by turning the equipment off and on, the user is encouraged to try to correct the interference by one or more of the following measures:

- *Reorient or relocate the receiving antenna.*
- *Increase the separation between the equipment and receiver.*
- *Connect the equipment to an outlet on a circuit different from that to which the receiver is connected.*
- *Consult the dealer for technical assistance.*

When condensation occurs inside the transceiver:

Condensation possibly occurs inside the transceiver in such a case where the room is warmed using a heater on cold days or where the transceiver is quickly moved from a cold room to a warm room. When condensation occurs, the microcomputer and/or the transmit/receive circuits may become unstable, resulting in transceiver malfunction. If this happens, turn OFF the transceiver and just wait for a while. When the condensed droplets disappear, the transceiver will function normally.

PRECAUTIONS

Please observe the following precautions to prevent fire, personal injury, and transceiver damage:

- When operating mobile, do not attempt to configure your transceiver while driving because it is simply too dangerous.
- Be aware of local laws pertaining to the use of headphones/headsets while driving on public roads. If in doubt, do not wear headphones while mobiling.
- Do not transmit with high output power for extended periods. The transceiver may overheat.
- Do not modify this transceiver unless instructed by this manual or by **KENWOOD** documentation.
- Do not expose the transceiver to long periods of direct sunlight nor place the transceiver close to heating appliances.
- Do not place the transceiver in excessively dusty areas, humid areas, wet areas, nor on unstable surfaces.
- If an abnormal odor or smoke is detected coming from the transceiver, turn OFF the power immediately. Contact a **KENWOOD** service station or your dealer.
- The transceiver is designed for a 13.8 V power source. Never use a 24 V battery to power the transceiver.

CONTENTS

SUPPLIED ACCESSORIES	1	SELECTING A BAND	15
CONVENTIONS FOLLOWED IN THIS MANUAL	1	SELECTING FREQUENCIES	16
CHAPTER 1 PREPARATION FOR MOBILE AND FIXED STATION OPERATION		Tuning Control	16
MOBILE INSTALLATION	2	Microphone [UP]/ [DWN] Buttons	16
Installation Example	2	TRANSMITTING	17
Installation Steps	2	Selecting Output Power	17
DC POWER CABLE CONNECTION	3	CHAPTER 5 EASY OPERATION	
Mobile Operation	3	CHAPTER 6 MENU SET-UP	
Fixed Station Operation	4	WHAT IS A MENU?	19
Replacing Fuses	5	MENU ACCESS	19
ANTENNA CONNECTION	5	MENU CONFIGURATION	20
ACCESSORY CONNECTIONS	6	CHAPTER 7 OPERATING THROUGH REPEATERS	
External Speaker	6	REPEATER ACCESS	22
Microphone	6	Selecting Offset Direction	23
PACKET EQUIPMENT CONNECTIONS	6	Selecting Offset Frequency	23
CHAPTER 2 YOUR FIRST QSO		Activating Tone Function	24
CHAPTER 3 GETTING ACQUAINTED		Selecting a Tone Frequency	24
BASIC TRANSCEIVER MODES	8	Automatic Repeater Offset (U.S.A./ Canada/ Europe Only)	25
BUTTON FUNCTION DISPLAY	9	REVERSE FUNCTION	26
FRONT PANEL	10	CHAPTER 8 MEMORY CHANNELS	
REAR PANEL	12	SIMPLEX & REPEATER OR ODD-SPLIT MEMORY CHANNEL?	27
MICROPHONE	13	STORING SIMPLEX FREQUENCIES OR STANDARD REPEATER FREQUENCIES	28
INDICATORS	14	STORING ODD-SPLIT REPEATER FREQUENCIES	28
CHAPTER 4 OPERATING BASICS		RECALLING MEMORY CHANNELS	29
SWITCHING POWER ON/OFF	15	CLEARING MEMORY CHANNELS	29
ADJUSTING VOLUME	15		
ADJUSTING SQUELCH	15		

NAMING MEMORY CHANNELS	30
SWITCHING MEMORY NAME/ FREQUENCY DISPLAY	30
CALL CHANNEL	31
Recalling the Call Channel	31
Changing Call Channel Contents	31
MEMORY → VFO TRANSFERS	32
CHANNEL DISPLAY FUNCTION	32
INITIALIZING MEMORY	33
Partial Reset (VFO)	33
Full Reset (Memory)	33

CHAPTER 9 PROGRAMMABLE MEMORY (PM)

PROGRAMMABLE INFORMATION	34
APPLICATION EXAMPLES	35
STORING DATA IN PM CHANNELS	36
RECALLING PM CHANNELS	36
AUTO PM CHANNEL STORAGE	37
RESETTING PROGRAMMABLE MEMORY	37

CHAPTER 10 SCAN

SCAN RESUME METHODS	39
Selecting Scan Resume Method	39
VFO SCAN	40
MEMORY SCAN	40
Locking Out Memory Channels	41
MHz SCAN	41
PROGRAM SCAN	42
Setting Scan Limits	42
Using Program Scan	43

CALL/VFO SCAN	43
CALL/MEMORY SCAN	43
PRIORITY SCAN	44
Storing Frequency in Priority Channel	44
Selecting Priority Scan Method	45
Using Priority Scan	45

CHAPTER 11 CONTINUOUS TONE CODED SQUELCH SYSTEM (CTCSS)

USING CTCSS	46
Automatic Tone Frequency ID	47

CHAPTER 12 DUAL TONE MULTI-FREQUENCY (DTMF) FUNCTIONS (U.S.A./ CANADA ONLY)

MAKING DTMF CALLS	48
Autopatch	48
Mic Keypad Confirmation Tones	48
STORING DTMF NUMBERS FOR AUTOMATIC DIALER	49
CONFIRMING STORED DTMF NUMBERS	49
TRANSMITTING STORED DTMF NUMBERS	49

CHAPTER 13 PROGRAMMABLE FUNCTION (PF) KEYS

ASSIGNING FRONT PANEL KEY FUNCTIONS	50
ASSIGNING SPECIAL KEY FUNCTIONS	51

CHAPTER 14 AUXILIARY FUNCTIONS

TIME-OUT TIMER (TOT)	52
AUTOMATIC POWER OFF (APO)	52
PROGRAMMABLE VFO	53

KEYPAD DIRECT ENTRY (U.S.A./ CANADA ONLY)	54
Frequency Entry	54
Memory Channel Number Entry	54
Tone Frequency Number Entry	55
CHANGING FREQUENCY STEP SIZE	55
DISPLAY DIMMER	56
Manual Dimmer Change	56
Auto Dimmer Change	56
BEEP VOLUME CHANGE	56
DISPLAY DEMONSTRATION	56
LOCK	57
Transceiver Lock	57
All Lock	57
POWER-ON MESSAGE	57
S-METER SQUELCH	58
Squelch Hang Time	58
ADVANCED INTERCEPT POINT (AIP)	59
SWITCHING AM/FM MODE (U.S.A./ CANADA ONLY)	59

**CHAPTER 15 MICROPHONE CONTROL
(U.S.A./ CANADA ONLY)**

CHAPTER 16 PACKET OPERATION

1200/ 9600 bps OPERATION	61
DATA Connector Pin Functions	62

CHAPTER 17 VS-3 VOICE SYNTHESIZER (OPTIONAL)

CHAPTER 18 CROSS-BAND OPERATION

CHAPTER 19 CLONE

CHAPTER 20 OPTIONAL ACCESSORIES

CHAPTER 21 INSTALLING OPTIONS

INSTALLING THE VS-3 VOICE SYNTHESIZER UNIT	67
INSTALLING A DETACHABLE FRONT PANEL KIT (DFK-3C/ DFK-4C/ DFK-7C)	67
Installation Examples	69

CHAPTER 22 MAINTENANCE

GENERAL INFORMATION	70
SERVICE	70
SERVICE NOTE	70
CLEANING	70
TROUBLESHOOTING	71

SPECIFICATIONS

POWER ON FUNCTIONS SUMMARY

INDEX

SUPPLIED ACCESSORIES

Accessory	Part Number	Quantity
Microphone		
U.S.A./ Canada: MC-53DM ¹	T91-0586-XX	1
Europe/ General: MC-45 ¹	T91-0396-XX	1
DC power cable	E30-2111-XX	1
Transceiver fuse (15 A)	F51-0017-XX	1
Mounting bracket	J29-0632-XX	1
Microphone hanger ² (U.S.A./ Canada only)	J19-1526-XX	1
Screw set (U.S.A./ Canada) ²	N99-0382-XX	1
Screw set (Europe/ General)	N99-0331-XX	1
Warranty card (U.S.A./ Canada/ Europe only)	—	1
Instruction manual	B62-0864-XX	1

¹ The MC-53DM and MC-45 microphones are also sold as optional accessories {page 66}.

² Attach the microphone hanger at an appropriate position.

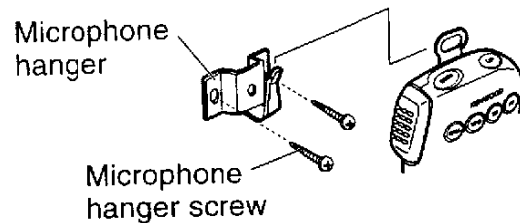

CONVENTIONS FOLLOWED IN THIS MANUAL

The writing conventions described below have been followed to simplify instructions and avoid unnecessary repetition.

ATTENTION: MOST PROCEDURES REQUIRE THAT YOU PRESS AN APPROPRIATE KEY IN EACH STEP WITHIN APPROXIMATELY 10 SECONDS, OR THE PREVIOUS MODE WILL BE RESTORED.

Instruction	What to do
Press [KEY].	Press and release KEY .
Press [KEY] (1 s).	Press and hold KEY for 1 second or longer.
Press [KEY1], [KEY2].	Press KEY1 momentarily, release KEY1 , then press KEY2 .
Press [KEY]+ POWER ON.	With transceiver power OFF, press and hold KEY , then turn ON the transceiver power by pressing [PWR].
Press [F], [KEY] (1 s).	Press [F] momentarily, release [F], then press and hold KEY for 1 second or longer.
Press [F]+[KEY].	Press and hold [F], then press KEY .

PREPARATION FOR MOBILE AND FIXED STATION OPERATION

1

MOBILE INSTALLATION

Install the transceiver in a safe, convenient position inside your vehicle that minimizes danger to your passengers and yourself while the vehicle is in motion. For example, consider installing the transceiver under the dash in front of the passenger seat so that knees or legs will not strike the radio during sudden braking of your vehicle. Try to pick a well-ventilated location that is shielded from direct sunlight.

■ Installation Example

Use the supplied mounting bracket to install the transceiver inside your vehicle. To enjoy the best viewing angle, you can position the transceiver in the bracket in a number of ways as shown below.

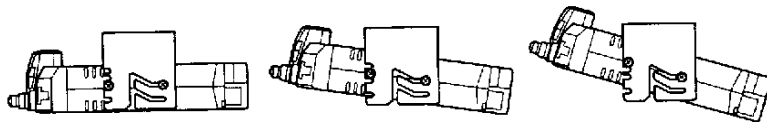

■ Installation Steps

- 1 Install the mounting bracket in the vehicle using the supplied flat washers and self-tapping screws. There are 4 washers and 4 screws supplied.

- The bracket can be mounted with the bracket opening for the transceiver facing down for underdash mounting, or with the opening facing up.
- The bracket must be installed so that the 4 screw holes on the edge of each bracket side are facing forward.

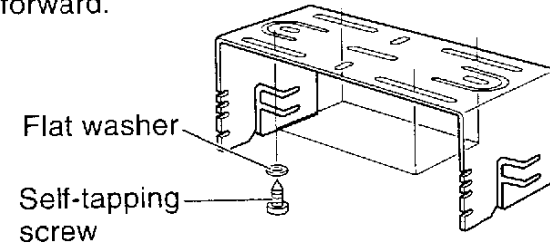

- 2 Position the transceiver, then insert and tighten the supplied hexagon SEMS screws and washers. There are 2 screws and 2 washers supplied for each side of the bracket.

- Double check that all hardware is tightened to prevent vehicle vibration from loosening the bracket or transceiver.

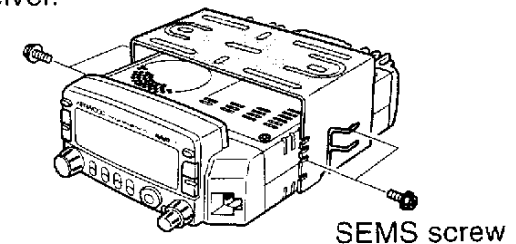

DC POWER CABLE CONNECTION

■ Mobile Operation

The vehicle battery must have a nominal rating of 12 V. Never connect the transceiver to a 24 V battery. Be sure to use a 12 V vehicle battery that has sufficient current capacity. If the current to the transceiver is insufficient, the display may darken during transmission, or transmit output power may drop excessively.

- 1 Route the DC power cable supplied with the transceiver directly to the vehicle's battery terminals using the shortest path from the transceiver.
 - If using a noise filter, it should be installed with an insulator to prevent it from touching metal on the vehicle.
 - It is not recommended to use the cigarette lighter socket since some cigarette lighter sockets introduce an unacceptable voltage drop.
 - If the power cable must be routed through a hole in the vehicle chassis or body, for example in the firewall at the front of the passenger compartment, use a rubber grommet to protect the cable from abrasion. Dismantle the fuse holder to pass the cable through the firewall.

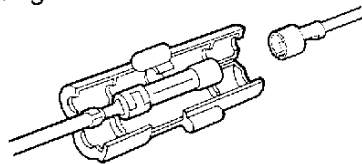

- The entire length of the cable must be dressed so it is isolated from heat, moisture, and the engine secondary (high voltage) ignition system/ cables.

- 2 After the cable is in place, wind heat-resistant tape around the fuse holder to protect it from moisture. Tie down the full run of cable.
- 3 To prevent the risk of short circuits, disconnect other wiring from the negative (-) battery terminal before connecting the transceiver.
- 4 Confirm the correct polarity of the connections, and attach the power cable to the battery terminals; red connects to the positive (+) terminal, black connects to the negative (-) terminal.
 - Use the full length of the cable without cutting off excess even if the cable is longer than required. In particular, never remove the fuse holders from the cable.

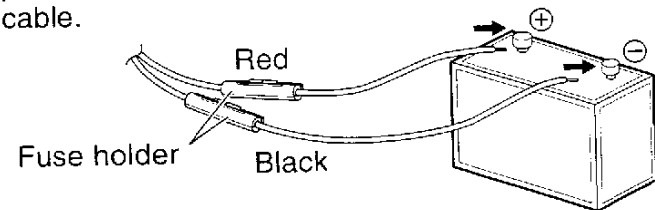

- 5 Reconnect any wiring removed from the negative terminal.
- 6 Connect the DC power cable to the transceiver's power supply connector.
 - Press the connectors firmly together until the locking tab clicks.

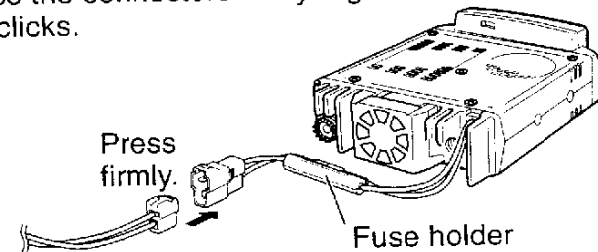

■ Fixed Station Operation

1

In order to use this transceiver for fixed station operation, you will need a separate 13.8 V DC power supply that must be purchased separately. The recommended current capacity of your power supply is 12 A.

- 1 Connect the DC power cable to the regulated DC power supply and check that polarities are correct (Red: positive, Black: negative).
 - DO NOT directly connect the transceiver to an AC outlet!
 - Use the supplied DC power cable to connect the transceiver to a regulated power supply.
 - Do not substitute a cable with smaller gauge wires.

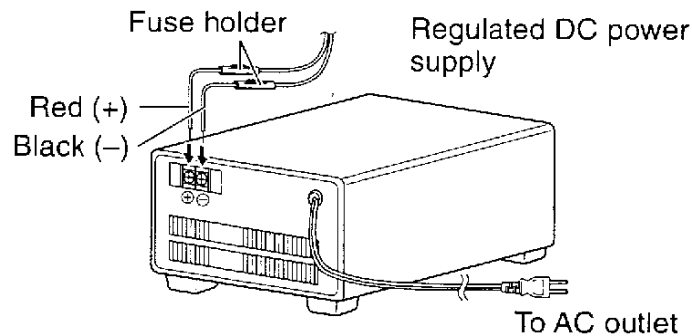

- 2 Connect the transceiver's DC power connector to the connector on the DC power cable.
 - Press the connectors firmly together until the locking tab clicks.

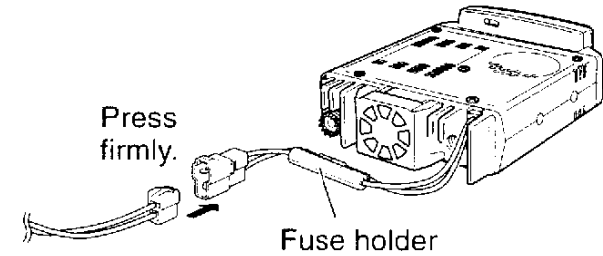

Note:

- ◆ For your transceiver to fully exhibit its performance capabilities, the following optional power supply is recommended: PS-33 (20.5 A, 25% duty cycle).
- ◆ Before connecting the DC power supply to the transceiver, be sure to switch the transceiver and the DC power supply OFF.
- ◆ Do not plug the DC power supply into an AC outlet until you make all connections.

■ Replacing Fuses

If the fuse blows, determine the cause then correct the problem. After the problem is resolved, replace the fuse. If newly installed fuses continue to blow, disconnect the power cable and contact your dealer or the nearest Service Center for assistance.

Fuse Location	Fuse Current Rating
Transceiver	15 A
Supplied Accessory DC Power Cable	20 A

CAUTION: ONLY USE FUSES OF THE SPECIFIED TYPE AND RATING.

Note: If you use the transceiver for a long period when the vehicle battery is not fully charged, or when the engine is OFF, the battery may become discharged, and will not have sufficient reserves to start the vehicle. Avoid using the transceiver under these conditions.

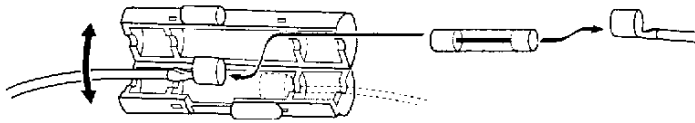

ANTENNA CONNECTION

1

Before operating, you must first install an efficient, well-tuned antenna. The success of your installation will depend largely on the type of antenna and its correct installation. The transceiver can give excellent results if the antenna system and its installation is given careful attention.

You should choose a 50 Ω impedance antenna to match the transceiver input impedance. Use low-loss coaxial feed line that also has a characteristic impedance of 50 Ω . Coupling the antenna to the transceiver via feed lines having an impedance other than 50 Ω reduces the efficiency of the antenna system, and can cause interference to nearby broadcast television receivers, radio receivers, and other electronic equipment.

CAUTION:

- ◆ TRANSMITTING WITHOUT FIRST CONNECTING AN ANTENNA OR OTHER MATCHED LOAD MAY DAMAGE THE TRANSCEIVER. ALWAYS CONNECT THE ANTENNA TO THE TRANSCEIVER BEFORE TRANSMITTING.
- ◆ ALL FIXED STATIONS SHOULD BE EQUIPPED WITH A LIGHTNING ARRESTER TO REDUCE THE RISK OF FIRE, ELECTRIC SHOCK, AND TRANSCEIVER DAMAGE.

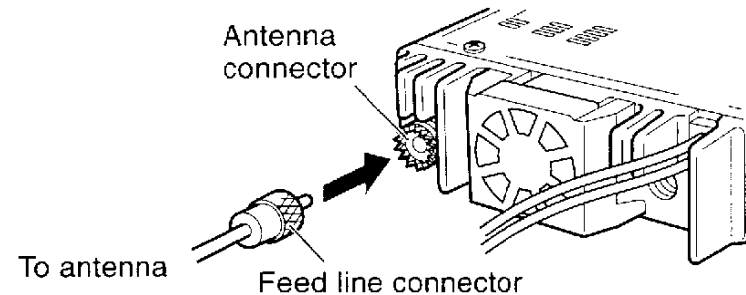

ACCESSORY CONNECTIONS

1

External Speaker

If you plan to use an external speaker, choose a speaker with an impedance of 8 Ω . The external speaker jack accepts a 3.5 mm (1/8") diameter mono (2-conductor) plug. Recommended speakers include the SP-50B and SP-41.

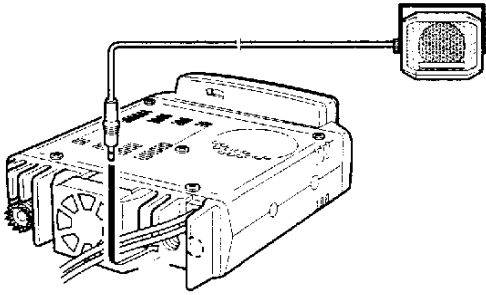

Microphone

To communicate in the voice modes, plug a 600 Ω microphone equipped with an 8-pin modular connector into the modular socket on the front panel of the transceiver. Press firmly on the plug until the locking tab clicks.

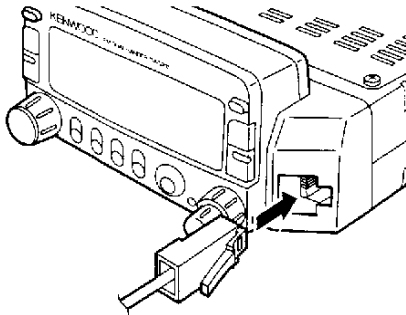

PACKET EQUIPMENT CONNECTIONS

If you intend to use this transceiver for Packet operation, you will need the following equipment.

- Personal computer with communications software
- Terminal Node Controller (TNC)
- TNC power supply
- RS-232C cable
- 6-pin mini DIN plug (optional PG-5A)

For the DATA connector pins, refer to "PACKET OPERATION" {page 61}.

Note:

- ◆ Do not share a single power supply between the transceiver and the TNC.
- ◆ Keep as wide a separation between the transceiver and computer as practical to reduce noise-pickup by the transceiver.
- ◆ One end of the optional PG-5A cable has not been connectorized. Attach the appropriate connector that mates with the TNC connector.

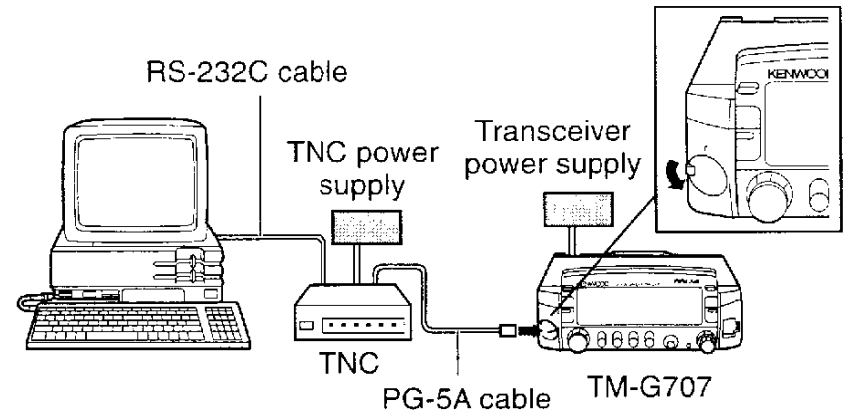

YOUR FIRST QSO

If you tend to discard instruction manuals along with the packaging materialplease don't. The 7 steps given here will get you on the air in your first QSO right away. So, you can enjoy the exhilaration that comes with opening a brand new transceiver.

After trying the rig for a while, settle back in your most comfortable operating chair with this manual and your favorite drink for an hour or two. The time spent will be worthwhile.



① Switch ON the DC power supply, then press the **PWR** switch.

②

② Turn the **VOL** and **SQL** controls to approximately 9 o'clock.

③ Press [**BAND**] to select the VHF or UHF band.

④ Turn the **Tuning** control to select a frequency.

⑤ Press and hold Mic [**PTT**], then speak in a normal tone of voice.

⑥ Release Mic [**PTT**] to receive.

⑦ Repeat steps ⑤ and ⑥ to continue communication.

GETTING ACQUAINTED

BASIC TRANSCEIVER MODES

- 3 This section introduces you to the basic modes you can select.

VFO mode

Press [VFO] to select. In this mode you can change the operating frequency using the **Tuning** control or Mic [UP]/ [DWN].

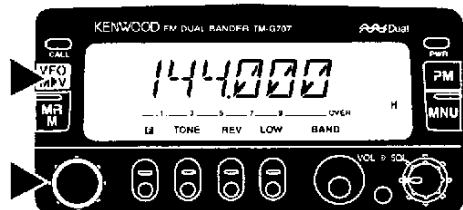

Memory Recall mode

Press [MR] to select. In this mode you can change memory channels, using the **Tuning** control or Mic [UP]/ [DWN], where you stored frequencies and related data. For further information, refer to “MEMORY CHANNELS” {page 27}.



Programmable Memory (PM) mode

Press [PM] to select. In this mode you can select the transceiver environment, by pressing [1] to [4], that you stored in PM channels {page 36}.

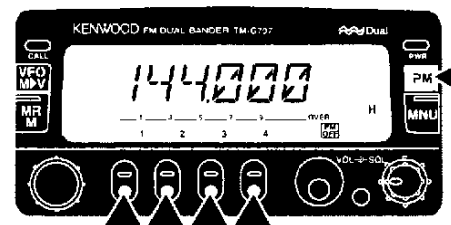

Menu mode

Press [MNU] to select. In this mode you can change Menu Nos. using the **Tuning** control or Mic [UP]/ [DWN]. For further information, refer to “MENU SET-UP” {page 19}.

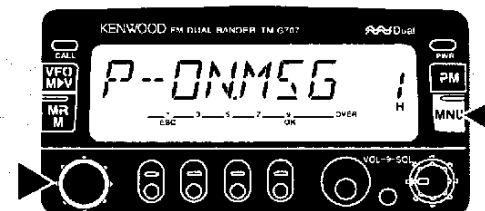

Easy Operation mode

Press **[MNU]+ POWER ON** to select. In this mode only the basic functions are available and the memory storing procedures are simplified. You may prefer this mode if you seldom use functions other than the basic ones. For further information, refer to "EASY OPERATION" {page 18}.

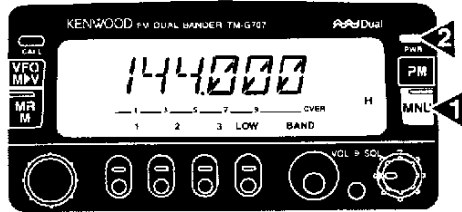

BUTTON FUNCTION DISPLAY

The lower portion of the display has labels that indicate the current function of each of the 5 front panel buttons. The *Italic font* is used to show these 5 buttons in the description of each operation step. After pressing **[F]**, pressing **[F]** again or waiting for 10 seconds restores the basic state.

3

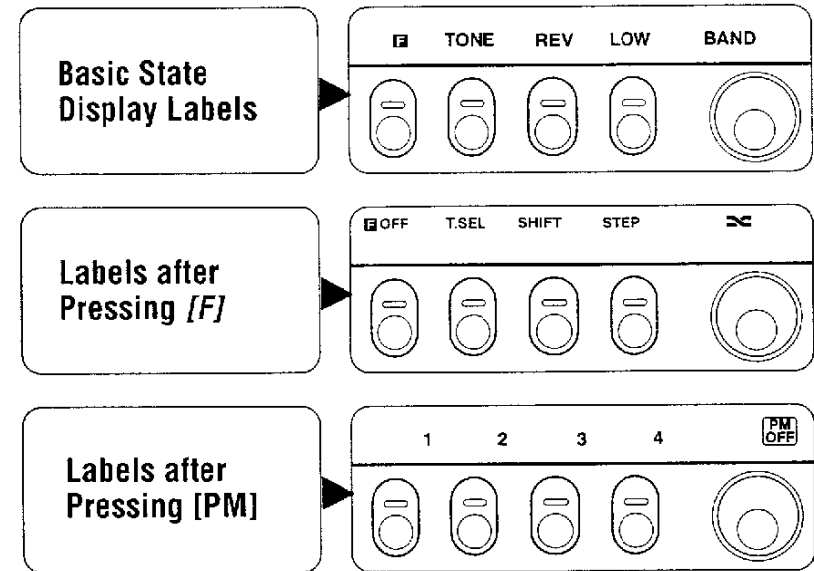

Note: After pressing **[F]**, press the appropriate key within approximately 10 seconds, or the Basic State display will be restored.

FRONT PANEL

Note: This section describes only the main functions of the front panel controls and buttons. For the functions not described here, you will find explanations in the appropriate sections of this manual.

3

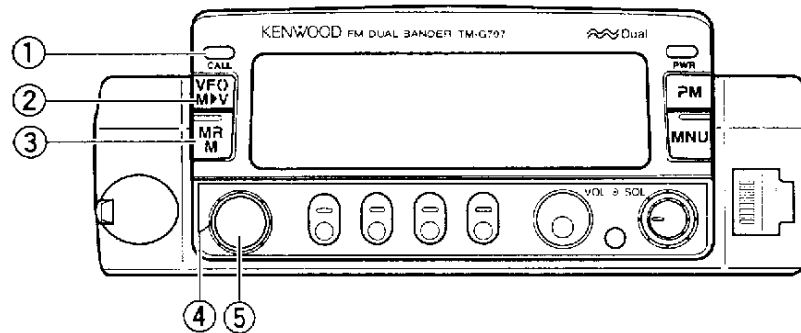

① CALL button

Recalls the Call channel {page 31}. Also starts or stops Call/VFO Scan {page 43} when in VFO mode, or Call/Memory Scan {page 43} when in Memory Recall mode.

② VFO button

Selects the VFO mode. In this mode you can change the operating frequency, using the **Tuning** control or Mic **[UP]/ [DWN]**. Also provides:

- VFO Scan start/stop to scan the entire VFO range {page 40}.
- Program Scan start/stop to scan a programmed range of frequencies {page 43}.

③ MR button

Selects the Memory Recall mode {page 29}. In this mode you can change memory channels, using the **Tuning** control or Mic **[UP]/ [DWN]**. Also starts or stops Memory Scan {page 40}.

④ Tuning control

Selects:

- Operating frequencies when in VFO mode {page 16}.
- Memory channels when in Memory Recall mode {page 29}.
- Menu Nos. when in Menu mode {page 19}.

This control is used for various other selections.

⑤ MHz button

Selects the MHz mode. In this mode you can change the operating frequency in 1 MHz steps or 10 MHz steps {page 16}, using the **Tuning** control or Mic **[UP]/ [DWN]**. Also starts or stops MHz Scan {page 41}.

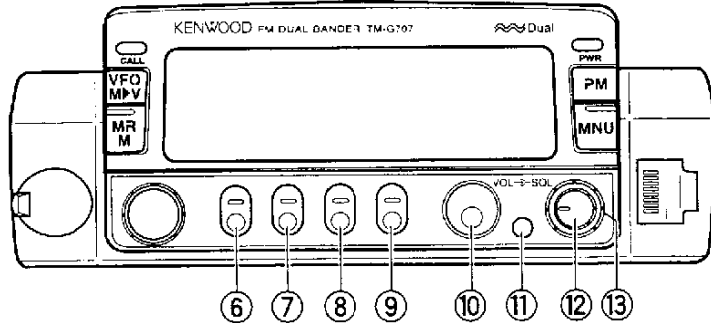

⑥ F (Function) button

Allows you to select the different functions that are available using the multifunction buttons.

⑦ TONE button

Switches the Tone function {page 24} or CTCSS function {page 46} ON or OFF. Also activates or deactivates Automatic Tone frequency ID {page 47}.

⑧ REV button

Switches the transmit frequency and receive frequency when operating with a standard transmit offset {page 23} or an odd-split memory channel {page 28}.

⑨ LOW button

Selects High, Medium, or Low transmit output power {page 17}.

⑩ BAND button

Selects the VHF or UHF band. On some versions, also selects the 118 MHz band.

⑪ DIM button

Selects the display illumination from 5 levels, including OFF {page 56}.

⑫ VOL control

When turned, adjusts the level of receive audio from the speaker {page 15}.

⑬ SQL control

When turned, adjusts the squelch threshold level {page 15}. This allows you to mute speaker output while no stations are being received.

3

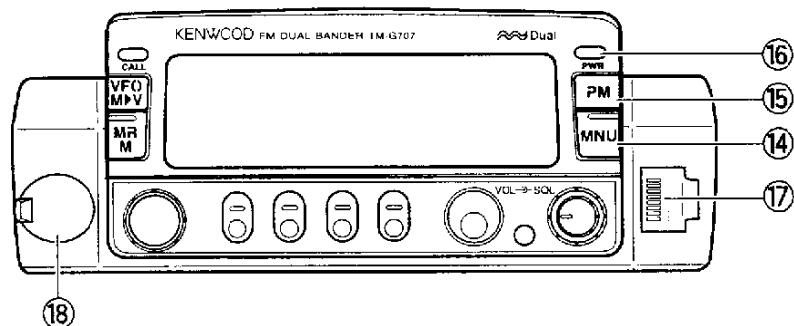

14 MNU button

Selects the Menu mode {page 19}.

15 PM button

Selects the Programmable Memory mode {page 36}.

16 PWR switch

Switches the transceiver ON or OFF {page 15}.

17 Microphone connector

Insert the 8-pin modular connector plug until the locking tab “clicks”.

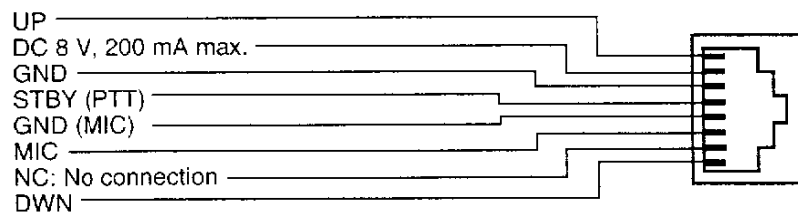

18 DATA connector

Connect a Terminal Node Controller (TNC) for Packet operation. Accepts a 6-pin mini DIN plug {page 6}.

REAR PANEL

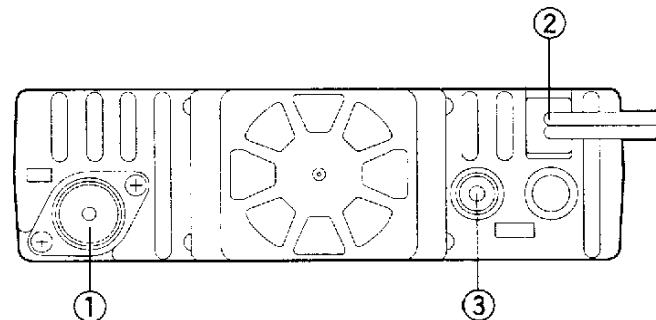

1 Antenna connector

Connect an external antenna {page 5}. When making test transmissions, connect a dummy load in place of the antenna. The antenna system or load should have an impedance of 50 Ω. The TM-G707E accepts a male N-type connector and other versions accept a male PL-259 connector. This transceiver has only one antenna connector because of a built-in duplexer.

2 Power Input 13.8 V DC cable

Connect a 13.8 V DC power source. Use the supplied DC power cable {pages 3 and 4}.

3 Speaker jack

If you wish, connect an optional external speaker for clearer audio. This jack accepts a 3.5 mm (1/8") diameter, 2-conductor plug. See page 6 for more information. The right jack is unavailable.

MICROPHONE

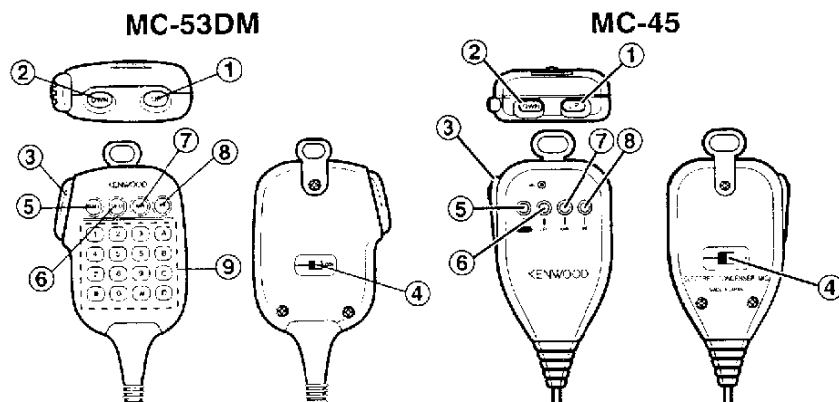

- ① UP button
- ② DWN button

Raises or lowers the operating frequency, the memory channel number, the menu number, etc. Holding either button down causes the action to be repeated. Also, switches between values for functions with multiple choices.

- ③ PTT (Push-to-talk) switch

Press and hold to transmit, then release to receive.

- ④ LOCK switch

Locks all microphone keys except [PTT] and the DTMF keypad, if equipped.

- ⑤ CALL key
- ⑥ VFO key
- ⑦ MR key

Identical to the front panel **CALL**, **VFO** and **MR** buttons. These keys can be re-programmed, if desired {page 50}.

- ⑧ PF key

Depending on which function you select by accessing "PF1" in Menu No. 20 {page 51}, the function of this key differs. Refer to "PROGRAMMABLE FUNCTION (PF) KEYS" {page 50}.





- ⑨ DTMF keypad (MC-53DM only)

The 16-key keypad is used for DTMF functions {page 48}, or to directly enter a frequency or a memory channel number {page 54}.

INDICATORS

On the display you will see various indicators that show what you have selected. Sometimes you may not recall what those indicators mean or how you can cancel the current setting. In such a case, you will find this table very useful.

3

Indicator	What You Selected	What You Press to Cancel
	Transceiver Lock	[F], [MHz]
 (Blinking)	All Lock	[MHz]+ POWER ON then [F], [MHz]
 ¹	AM mode	Use Menu No. 0.
CT	CTCSS	[TONE]
T	Tone function	[TONE], [TONE]
-	Minus offset direction	[F], [SHIFT] (TM-G707E: one more [F], [SHIFT])
-- ²	Minus offset direction (-7.6 MHz)	[F], [SHIFT]
+	Plus offset direction	[F], [SHIFT], [F], [SHIFT] (TM-G707E: one more [F], [SHIFT])
R	Reverse	[REV]
PRI	Priority Scan	[F], [MNU]
	Cross-band Operation	[F], [

¹ U.S.A./ Canada only

² TM-G707E only

Indicator	What You Selected	What You Press to Cancel
APO	Automatic Power OFF	Use Menu No. 12.
9600	9600 bps transfer	Use Menu No. 19.
AIP	Advanced Intercept Point	[F], [DIM]
★	Locked-out memory channel	Use Menu No. 3.
▼	Memory channel containing data	—
	Transmit mode	Release Mic [PTT].
H	High transmit power	Default
M	Medium transmit power	[LOW], [LOW] to select the default (High)
L	Low transmit power	[LOW] to select the default (High)

When you receive a signal:

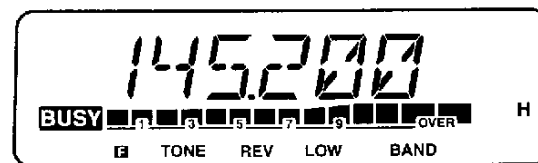

- "BUSY" appears when the squelch {page 15} is open.
- The S-meter shows the strength of received signals.

OPERATING BASICS

SWITCHING POWER ON/OFF

- 1 Switch ON the DC power supply.
 - If operating mobile, skip this step.
- 2 Press the **PWR** switch to switch ON the transceiver.

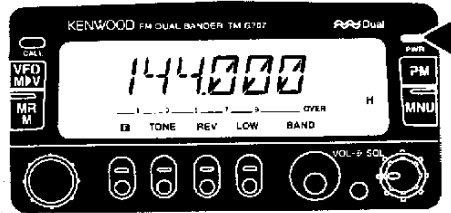

- 3 To switch OFF the transceiver, press the **PWR** switch again.
 - In a fixed installation, after the transceiver has been switched ON, it can then be switched OFF or ON by using only the power switch on the DC power supply.

ADJUSTING VOLUME

Turn the **VOL** control clockwise (or counterclockwise) to increase (or decrease) the audio level.

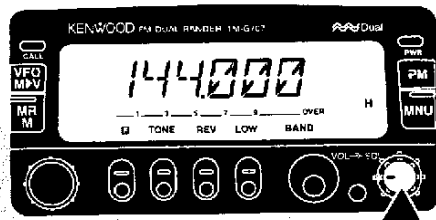

ADJUSTING SQUELCH

The purpose of the Squelch function is to silence background noise output from the speaker (squelch closed) when no signals are present. When the squelch level is set correctly, you will hear sound (squelch opened) only while a station is actually being received.

4

Turn the **SQL** control to just eliminate the background noise when no signal is present.

- As you turn the control clockwise, stronger signals are required to open the squelch.

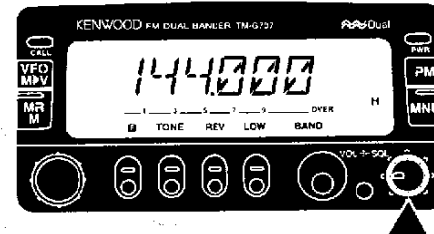

Note: The point at which ambient noise on a frequency just disappears, called the squelch threshold, depends on the frequency.

SELECTING A BAND

Press **[BAND]** to select the VHF or UHF band.

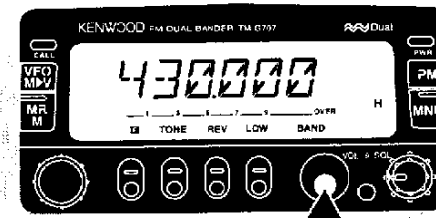

SELECTING FREQUENCIES

■ Tuning Control

Using the **Tuning** control is convenient when you are within easy reach of the transceiver front panel, and the frequencies to be selected are near the current frequency.

4

- 1 Press **[VFO]** to select VFO mode.

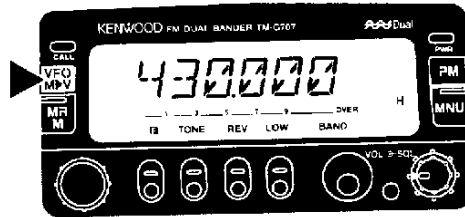

- 2 Turn the **Tuning** control clockwise to increase the frequency or counterclockwise to decrease the frequency.

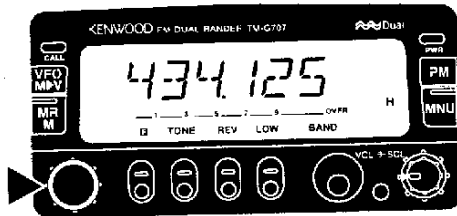

- You can also select frequencies via the microphone keypad (MC-53DM only). See "KEYPAD DIRECT ENTRY" {page 54}.
- To change frequencies in steps of 1 MHz, press **[MHz]** first. Pressing **[MHz]** again cancels the 1 MHz function.

- To change frequencies in steps of 10 MHz, press **[F]+[MHz]** first; do not press **[F]** for longer than 1 second. Pressing **[F]** cancels the 10 MHz function; pressing **[MHz]** starts the 1 MHz function.

Note: If you cannot select a particular frequency, you need to change the frequency step size. See "CHANGING FREQUENCY STEP SIZE" {page 55} for further information.

■ Microphone [UP]/ [DWN] Buttons

Using Mic **[UP]/ [DWN]** for frequency selection is useful when mobiling or any time you are not immediately in front of the transceiver.

Press Mic **[UP]** or **[DWN]** once to change the frequency by one step in the direction indicated by the button.

- Pressing and holding the button causes the frequency to step repeatedly. Release it to stop the frequency change.
- To change frequencies in steps of 1 MHz (or 10 MHz), press **[MHz]** (or **[F]+[MHz]**) first.

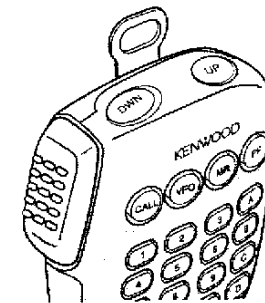

MC-53DM

TRANSMITTING

- 1 When ready to begin transmitting, press and hold Mic [PTT] and speak in a normal tone of voice.
 - “ON AIR” and the RF power meter appear.

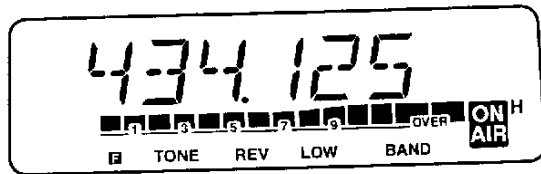

- Speaking too close to the microphone, or too loudly, may increase distortion and reduce intelligibility of your signal at the receiving station.
 - The RF power meter shows the relative transmit output power.
- 2 When you finish speaking, release Mic [PTT].

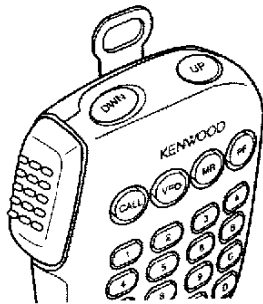

MC-53DM

■ Selecting Output Power

It's wise, and required by law, to select the lowest power that allows reliable communication. If operating from battery power, lower transmit power will give you more operating time before a charge is necessary. Reducing power lowers the risk of interfering with others on the band.

Press [LOW] to select high (“H”), medium (“M”), or low (“L”) power. The default is high.

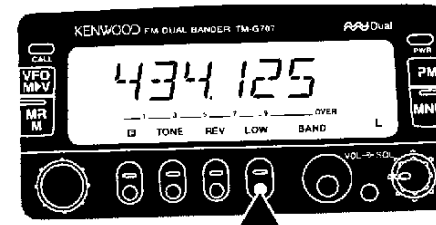

CAUTION:

- ◆ DO NOT TRANSMIT WITH HIGH OUTPUT POWER FOR EXTENDED PERIODS. THE TRANSCEIVER MAY OVERHEAT AND MALFUNCTION.
- ◆ CONTINUOUS TRANSMISSION CAUSES THE HEAT SINK TO OVERHEAT. NEVER TOUCH THE HEAT SINK WHEN IT MAY BE HOT.

Note: When the transceiver overheats because of ambient high temperature or continuous transmission, the protective circuit may function to lower transmit output power.

EASY OPERATION

If you are a person who has just acquired a ham license and wants to use only the basic functions for now, use Easy Operation mode. Only the basic functions are available in this mode so you need not worry about studying other functions.

5

When in this mode, you can store a simplex frequency in up to 3 memory channels by just pressing a single key; the channels are shared by both bands.

Press **[MNU]+ POWER ON** to enter (or exit) Easy Operation mode.

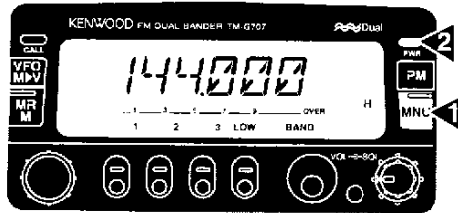

Note: Settings made in Easy Operation mode are independent of settings in the normal mode.

The available keys and functions in this mode are listed in the table. The **VOL** and **SQL** controls also function.

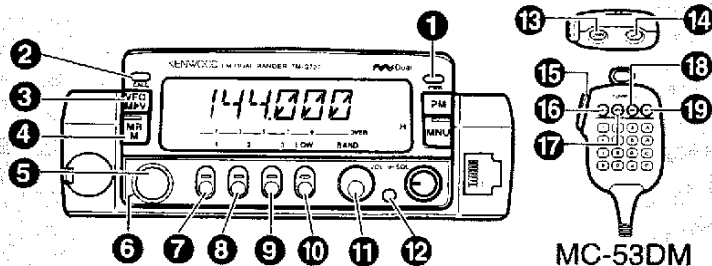

	Press	To	Page Ref.
①	PWR	switch ON (or OFF) the transceiver.	15
②	CALL	recall the Call channel.	31
②	CALL (1 s)	store the currently selected frequency in the Call channel.	31
③	VFO	select VFO mode.	8
④	MR	select Memory Recall mode.	—
⑤	MHz	change the frequency in steps of 1 MHz.	16
⑥	Tuning control	change the frequency.	16
⑦	1 (1 s)	store the currently selected frequency in memory channel 1, 2, or 3; ex. [1] (1 s) to store in channel 1.	—
⑧	2 (1 s)		
⑨	3 (1 s)		
⑦	1	recall memory channel 1, 2, or 3, if data stored; ex. [1] to recall channel 1.	—
⑧	2		
⑨	3		
⑩	LOW	switch the transmit output power.	17
⑪	BAND	change the current band.	15
⑫	DIM	change the display illumination.	56
⑬	Mic DWN	lower the operating frequency.	16
⑭	Mic UP	raise the operating frequency.	16
⑮	Mic PTT	transmit.	17
⑯	Mic CALL	recall the Call channel.	31
⑰	Mic VFO	select VFO mode.	8
⑱	Mic MR	select Memory Recall mode.	—
⑲	Mic PF	change the current band.	15

MENU SET-UP

WHAT IS A MENU?

Many functions on this transceiver are selected or configured via a software-controlled Menu instead of physical controls on the transceiver. Once familiar with the Menu system, you will appreciate the versatility it offers.

MENU ACCESS

- 1 Select the desired band.
 - For some Menu Nos., you can select a different setting on each band.
- 2 Press **[MNU]** to enter Menu mode.
 - The last Menu No. used appears.

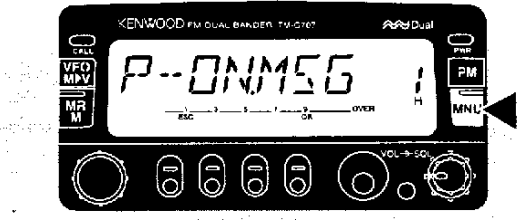

- 3 Turn the **Tuning** control, or press Mic **[UP]/ [DWN]**, to select the Menu No.
 - "ESC" and "OK" appear as button labels.
 - To cancel the selection and restore the previous display, press **[ESC]**.

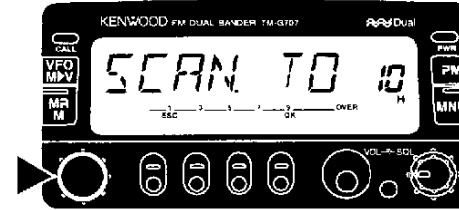

- 4 Press **[OK]**.
 - Depending on Menu Nos., "▶" also appears. For the subsequent steps, see the appropriate sections in this manual.
- 5 Turn the **Tuning** control, or press Mic **[UP]/ [DWN]**, to switch the selection.

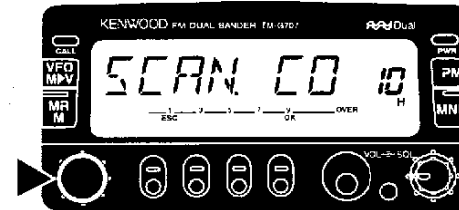

- 6 Press **[OK]** again to complete the setting and exit Menu mode.

Note: As required, operate keys or the **Tuning** control in each step within approximately 10 seconds, or the previous mode will be restored.

MENU CONFIGURATION

Note: For the shaded Menu functions, select the appropriate band (VHF or UHF) before entering Menu mode.

Menu No.	Description	Selections	Default	Ref. Page
0	AM/ FM Mode Switch (U.S.A./ Canada only)	AM/ FM	See reference page	59
1	Power-On Message	See reference page	KENWOOD	57
2	Auto Dimmer Change	ON/ OFF	OFF	56
3	Memory Channel Lockout ¹	ON/ OFF	OFF	41
4	Memory Recall Method	All bands (ALL)/ Single band (ONE)	All bands	29
5	Memory Channel Name ¹	See reference page		30
6	Auto PM Channel Storage	ON/ OFF	OFF	37
7	Automatic Repeater Offset (U.S.A./ Canada/ Europe only)	ON/ OFF	ON	25
8	Offset Frequency	00.00 MHz ~ 29.95 MHz in steps of 50 kHz	See reference page	23
9	Programmable VFO (Upper/ lower limits)	Frequencies selectable on the band	Upper/lower RX frequency limits on the band	53
10	Scan Resume Method	Time-Operated (TO)/ Carrier-Operated (CO)	Time-Operated	39
11	Priority Scan Method	Mode A/ Mode B	Mode A	45
12	Automatic Power Off (APO)	ON/ OFF	OFF	52
13	Time-Out Timer (TOT)	3/ 5/ 10 minutes	10 minutes	52
14	S-meter Squelch	ON/ OFF	OFF	58
15	S-meter Squelch Hang Time ²	125 ms/ 250 ms/ 500 ms/ OFF	OFF	58

¹ Menu No. 3 and No. 5 are selectable only after a memory channel has been recalled.

² Menu No. 15 is selectable only when S-meter Squelch is ON.

Menu No.	Description	Selections	Default	Ref. Page
16	Beep Volume	Level 1 (min.) ~ 7 (max.) / OFF	Level 5	56
17	Voice Synthesizer ¹	English/ Japanese/ OFF	English	63
18	DIM/ VOICE Function Switch ¹	DIM/ VOICE	DIM	63
19	Data Transfer Rate	1200 bps/ 9600 bps	1200 bps	61
20 ~ 23	Programmable Function Keys	See reference page	User setting	51
24, 25	Not currently used			
26	1750 Hz Tone Transmit Hold (TM-G707E only)	ON/ OFF	OFF	51
27	Microphone Control (U.S.A./ Canada only)	ON/ OFF	OFF	60
28	Mic Keypad Confirmation Tones (U.S.A./ Canada only)	ON/ OFF	OFF	48
29 ~ 38	DTMF Number Storage (U.S.A./ Canada only)	See reference page		49

6

¹ Menu No. 17 and No. 18 are selectable only when the optional VS-3 is installed.

OPERATING THROUGH REPEATERS

Repeaters are often installed and maintained by radio clubs, sometimes with the cooperation of local businesses involved in the communications industry.

Compared to simplex communication, you can usually transmit over much greater distances by using a repeater. Repeaters are typically located on a mountain top or other elevated location. Often they operate at higher ERP (Effective Radiated Power) than a typical station. This combination of elevation and high ERP allows communications over considerable distances.

7

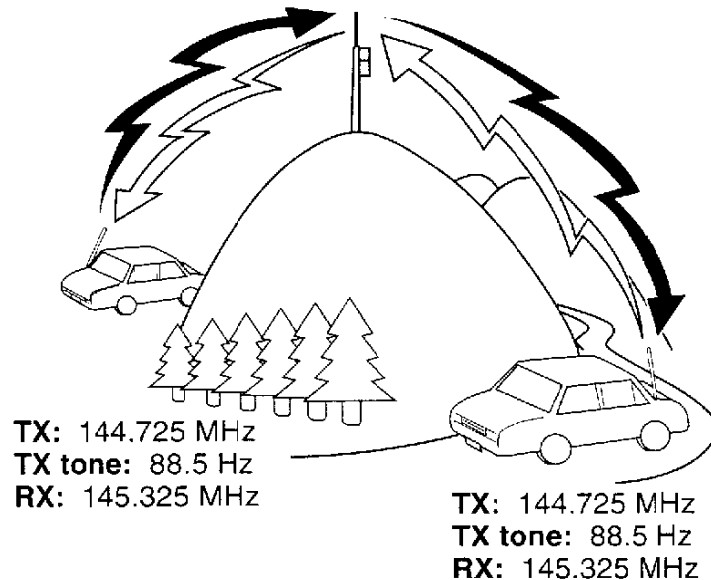

REPEATER ACCESS

Most amateur radio voice repeaters use a separate receive and transmit frequency. You can set a separate transmit frequency by selecting the offset frequency and offset direction with respect to the receive frequency. In addition, some repeaters may require the transceiver to transmit a tone before the repeater can be used. To transmit this required tone, activate the Tone function and select a tone frequency.

The required offset direction, offset frequency, and tone frequency depend on the repeater you are accessing. Consult your local repeater reference.

Flow Chart for Repeater Access

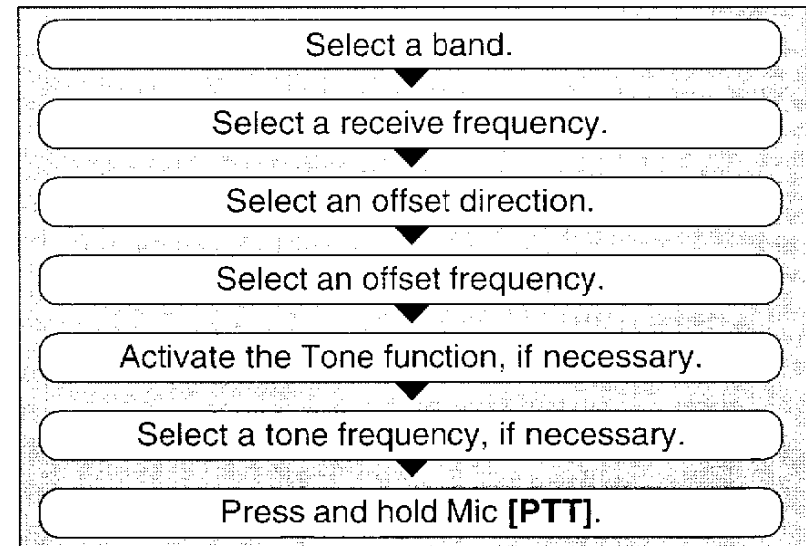

■ Selecting Offset Direction

Select whether the transmit frequency will be higher (+) or lower (-) than the receive frequency.

- 1 Select the desired band.
- 2 Press **[F]**, **[SHIFT]**.
 - Each time you repeat this key operation, the offset direction changes as shown below.

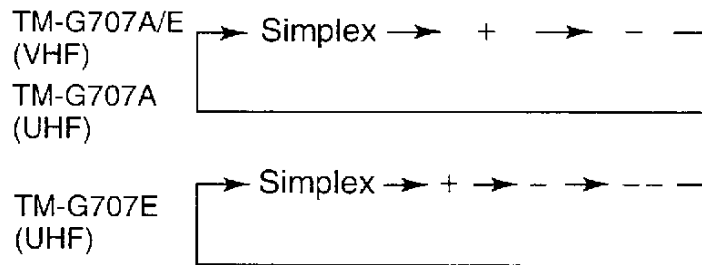

Note:

- ◆ If the offset transmit frequency falls outside the allowable transmit frequency range, transmitting is inhibited. Use one of the following methods to bring the transmit frequency into the allowable range:
 - Move the receive frequency further inside the band.
 - Change the offset direction.
- ◆ While using an odd-split memory channel or transmitting, you cannot change the offset direction.

TM-G707E Only: If you select "-" for the offset direction, you cannot change the default offset frequency (7.6 MHz).

■ Selecting Offset Frequency

Select how much the transmit frequency will be offset from the receive frequency. The default offset frequency on the VHF band is 600 kHz no matter which market version; the default on the UHF band is 5 MHz (TM-G707A) or 1.6 MHz (TM-G707E).

- 1 Select the desired band.
- 2 Press **[MNU]** to enter Menu mode.
- 3 Select Menu No. 8 (OFS).

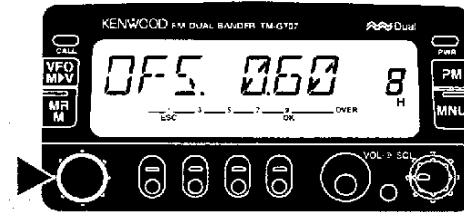

- 4 Press **[OK]**, then select the appropriate offset frequency.
 - The selectable range is from 00.00 MHz to 29.95 MHz in steps of 50 kHz.

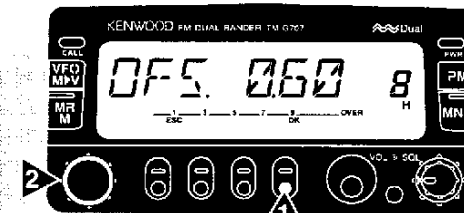

- 5 Press **[OK]** again to complete the setting and exit Menu mode.

Note: After changing the offset frequency, the new offset frequency will also be used by Automatic Repeater Offset.

■ Activating Tone Function

- 1 Select the desired band.
- 2 Press **[TONE]** to activate the Tone function.
 - Each time you press **[TONE]**, the selection changes as shown below.

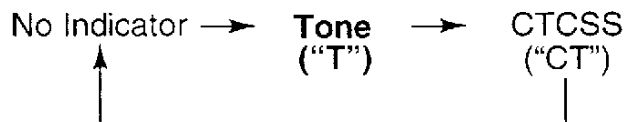

TM-G707E Only: When you access repeaters that require 1750 Hz tones, you need not activate the Tone function. No matter which selection you make here, pressing the Mic PF key assigned the 1750 Hz Tone function {page 51} causes the transceiver to transmit 1750 Hz tones.

■ Selecting a Tone Frequency

- 1 Select the desired band.
- 2 Press **[TONE]** to activate the Tone function.
- 3 Press **[F]**, **[T.SEL]**.
 - The current tone frequency appears and blinks. The default is 88.5 Hz.

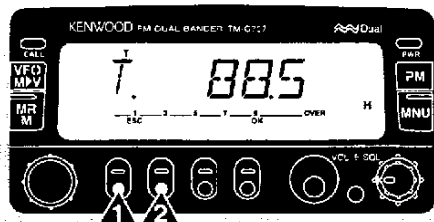

- 4 Turn the **Tuning** control, or press Mic **[UP]**/ **[DWN]**, to select a tone frequency.

- 5 Press **[OK]** to complete the setting.

TM-G707E Only: To transmit a 1750 Hz tone, assign the 1750 Hz Tone function to one of the Programmable Function (PF) keys of the microphone {page 51}.

Note: If you store tone settings in memory channels, you need not make the settings every time. Recalling the memory channels will restore the tone settings which you make this time. Refer to "MEMORY CHANNELS" {page 27}.

No.	Freq. (Hz)	No.	Freq. (Hz)	No.	Freq. (Hz)	No.	Freq. (Hz)
01	67.0	11	97.4	21	136.5	31	192.8
02	71.9	12	100.0	22	141.3	32	203.5
03	74.4	13	103.5	23	146.2	33	210.7
04	77.0	14	107.2	24	151.4	34	218.1
05	79.7	15	110.9	25	156.7	35	225.7
06	82.5	16	114.8	26	162.2	36	233.6
07	85.4	17	118.8	27	167.9	37	241.8
08	88.5	18	123.0	28	173.8	38	250.3
09	91.5	19	127.3	29	179.9		
10	94.8	20	131.8	30	186.2		

U.S.A./ Canada Only: Use Nos. 01 to 38 shown in the table above when selecting tone frequencies via Keypad Direct Entry {page 55}.

■ Automatic Repeater Offset (U.S.A./ Canada/ Europe Only)

This function automatically selects an offset direction and activates the Tone function, according to the frequency that you select on the VHF band. The transceiver is programmed for offset direction as shown below. To obtain an up-to-date band plan for repeater offset direction, contact your national Amateur Radio association.

U.S.A. and Canada versions

This complies with the standard ARRL band plan.

144.0	145.5	146.4	147.0	147.6					
	145.1	146.0	146.6	147.4	148.0 MHz				
S	-	S	+	S	-	+	S	-	

S: Simplex

European versions

144.0				145.6	145.8	146.0 MHz
		S			-	S

S: Simplex

Note: Automatic Repeater Offset does not function when Reverse or CTCSS is ON. However, pressing **[REV]** after Automatic Repeater Offset has selected an offset (split) status, exchanges the receive and transmit frequencies.

- 1 Select the VHF band.
- 2 Press **[MNU]** to enter Menu mode.
- 3 Select Menu No. 7 (ARO).



- 4 Press **[OK]**, then switch the function ON (default) or OFF.

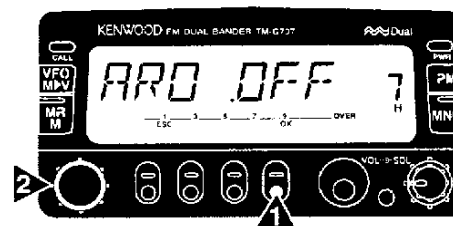

- 5 Press **[OK]** again to complete the setting and exit Menu mode.

7

REVERSE FUNCTION

After setting a separate receive and transmit frequency, you can exchange these frequencies using the Reverse function. While using a repeater, this function allows you to check the signal strength of a station accessing the repeater. If the station's signal is strong, move to a simplex frequency to continue the contact and free up the repeater.

7

Press **[REV]** to switch the Reverse function ON (or OFF).

- "R" appears when the function is ON.

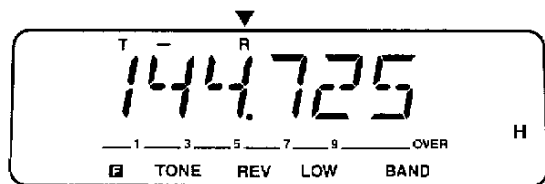

Note:

- ◆ If pressing **[REV]** places the transmit frequency outside the allowable transmit frequency range, then pressing Mic **[PTT]** causes an error beep to sound; transmission is inhibited.
- ◆ If pressing **[REV]** places the receive frequency outside the receive frequency range, an error beep sounds and no reversal occurs.
- ◆ Automatic Repeater Offset does not function while Reverse is ON.
- ◆ You cannot switch Reverse ON or OFF while transmitting.

MEMORY CHANNELS

In memory channels, you can store frequencies and related data that you often use. Then you need not reprogram those data every time. You can quickly recall wanted channels by simple operation. A total of 180 memory channels are available for VHF and UHF.

You can also store a name for each memory channel. For more information, see “NAMING MEMORY CHANNELS” {page 30}.

SIMPLEX & REPEATER OR ODD-SPLIT MEMORY CHANNEL?

You can use each memory channel as a simplex & repeater channel or odd-split channel. Store only one frequency to use as a simplex & repeater channel or two separate frequencies to use as an odd-split channel. Select either application for each channel depending on the operations you have in mind.

Simplex & repeater channel allows:

- Simplex frequency operation
- Repeater operation with a standard offset (If an offset direction is stored)

Odd-split channel allows:

- Repeater operation with a non-standard offset

Note: Not only can you store data in memory channels, but you can also overwrite existing data with new data.

The data listed below can be stored in each memory channel:

Parameter	Simplex & Repeater	Odd-split
Receive frequency	Yes	Yes
Transmit frequency		Yes
Tone frequency	Yes	Yes
Tone ON	Yes	Yes
CTCSS frequency	Yes	Yes
CTCSS ON	Yes	Yes
Frequency step size	Yes	Yes
Offset direction	Yes	N/A
Reverse ON	Yes	N/A
Memory channel lockout	Yes	Yes
Memory channel name	Yes	Yes

Yes: Can be stored in memory.

N/A: Not applicable

STORING SIMPLEX FREQUENCIES OR STANDARD REPEATER FREQUENCIES

- 1 Press **[VFO]** to select VFO mode.
- 2 Press **[BAND]** to select the desired band.
- 3 Turn the **Tuning** control, or press Mic **[UP]/ [DWN]**, to select the desired frequency.
 - You can also enter digits directly from the microphone keypad (MC-53DM only). See page 54.

8

- 4 If storing a standard repeater frequency, select the following data:

Offset direction {page 23}

Tone ON, if necessary {page 24}

Tone frequency, if necessary {page 24}

- If storing a simplex frequency, you may select other related data (CTCSS ON, CTCSS freq. etc.).

- 5 Press **[F]**.
 - A memory channel number appears.
 - A triangle icon appears above the memory channel number if the channel already contained data.
- 6 Turn the **Tuning** control, or press Mic **[UP]/ [DWN]**, to select the desired memory channel (within approx. 10 seconds).
- 7 Press **[MR]**.
 - The selected frequency and related data are stored in the memory channel.

STORING ODD-SPLIT REPEATER FREQUENCIES

Some repeaters use a receive and transmit frequency pair with a non-standard offset. To access those repeaters, store two separate frequencies in a memory channel. You then can operate on those repeaters without changing the offset programming in the Menu.

- 1 Select the appropriate receive frequency by using steps 1 to 6 (not 7) given for simplex or standard repeater frequencies.
 - If necessary, select Tone ON {page 24} and tone frequency {page 24}.
- 2 Press **[MR]** (1 s).
 - “-” and “+” appear.

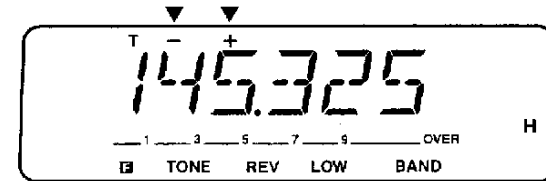

- 3 Select the appropriate transmit frequency (within approx. 10 seconds).
- 4 Press **[MR]**.
 - The selected transmit frequency is stored in the memory channel.

Note:

- ◆ When you recall an odd-split memory channel, “-” and “+” appear on the display. Press **[REV]** to display the transmit frequency.
- ◆ In step 2 you cannot use Mic **[MR]**, nor Mic **[PF]** programmed with Memory Recall.
- ◆ Transmit Offset status and Reverse status are not stored in an odd-split memory channel.

RECALLING MEMORY CHANNELS

- 1 Press **[MR]** to enter Memory Recall mode.
 - The memory channel used last is recalled.



- 2 Turn the **Tuning** control, or press Mic **[UP]/ [DWN]**, to select the desired memory channel.
 - You can also recall memory channels by directly entering numeric digits via the microphone keypad (MC-53DM only). See page 54.
 - You cannot recall empty memory channels.
 - To restore VFO mode, press **[VFO]**.

You may want to recall only memory channels that store frequencies of the current band. Access Menu No. 4 (MR) to select "ONE". The default is "ALL".

ONE: Recalls only memory channels of the current band.

ALL: Recalls all programmed memory channels. For example, allows you to recall a VHF frequency channel when operating the UHF band.

Note:

- ◆ When you recall an odd-split memory channel, "-" and "+" appear on the display. Press **[REV]** to display the transmit frequency.
- ◆ After recalling a memory channel, you may program data such as Tone or CTCSS. These settings, however, are cleared once you select another channel or the VFO mode. To permanently store the data, overwrite the channel contents (page 28).

CLEARING MEMORY CHANNELS

- 1 Recall the desired memory channel.
- 2 Switch OFF the power to the transceiver.
- 3 Press **[MHz]+ POWER ON**.
 - A confirmation message appears.

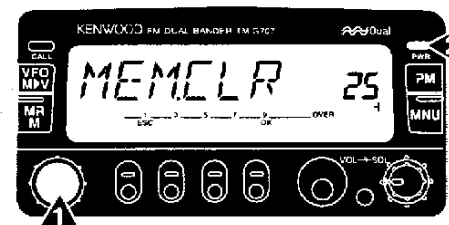

- 4 Press **[OK]**.
 - The contents of the selected memory channel are erased.

NAMING MEMORY CHANNELS

You can name memory channels using up to 7 alphanumeric characters. When you recall a named memory channel, its name appears on the display instead of the stored frequency. Names can be call signs, repeater names, cities, names of people, etc.

Note: You can also name the Priority channel, but you cannot name the Call, L1 to L6, nor U1 to U6 channels.

- 1 Recall the desired memory channel.
- 2 Press **[MNU]** to enter Menu mode.
- 3 Select Menu No. 5 (MEM.NAME).

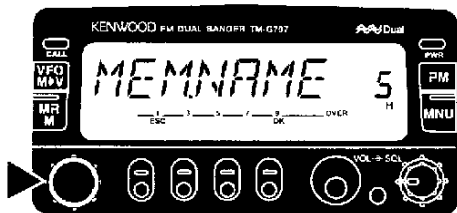

- 4 Press **[OK]**.
 - The first digit blinks.

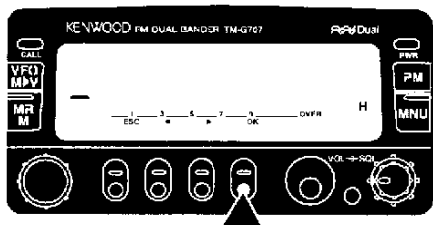

- If you recall a memory channel that has a name stored, the last digit blinks.
- 5 Turn the **Tuning** control, or press Mic **[UP]/ [DWN]**, to select the first digit.

- You can select "0" to "9", "A" to "Z", "-", "/", or a space.
- To enter a dot after the digit, press **[MR]**. Pressing **[MR]** again clears the dot.

- 6 Press **[▶]**.
 - The second digit blinks.
- 7 Repeat steps 5 and 6 to enter up to 7 digits.
 - After selecting the 7th digit, you need not press **[▶]**.
 - To re-enter the preceding digit, press **[◀]**.
 - To clear all digits and move back to the first digit, press **[VFO]**.
- 8 Press **[OK]** to complete the setting and exit Menu mode.

Note:

- ◆ You can assign names only to memory channels in which you have stored frequencies and related data.
- ◆ The stored names can be overwritten by repeating steps 1 to 8.
- ◆ The stored names also are erased by clearing memory channels.

SWITCHING MEMORY NAME/ FREQUENCY DISPLAY

After storing memory names, you can switch the display between memory names and frequencies. You may sometimes want to confirm frequencies stored in named memory channels.

- 1 Press **[MR]** to enter Memory Recall mode.
- 2 Press **[MHz]** to switch between memory name and frequency display.

CALL CHANNEL

The Call channel can be used to store any frequency and related data that you will recall often. The Call channel also can be programmed either as a simplex & repeater or odd-split channel. No matter what mode the transceiver is in, the Call channel can always be selected quickly. You may want to dedicate the Call channel as an emergency channel within your group. In this case, the Call/VFO scan {page 43} will be useful.

The default frequency stored in the Call channel is shown below:

Version	VHF	UHF
U.S.A./ Canada	144.000 MHz	440.000 MHz
Europe/ General	144.000 MHz	430.000 MHz

The contents of the Call channel cannot be deleted; however, you can overwrite old data with new data as described in the following section.

■ Recalling the Call Channel

- 1 Select the desired band.
- 2 Press **[CALL]** to recall the Call channel.
 - “C” appears.

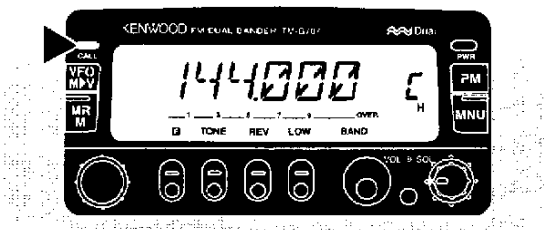

- To restore the previous mode, press **[CALL]** again.

■ Changing Call Channel Contents

- 1 Select the desired band.
- 2 Select the desired frequency and related data (Tone, CTCSS, etc.).
 - When you program the Call channel as an odd-split channel, select a receive frequency.
- 3 Press **[F]**, **[CALL]**.
 - The selected frequency and related data are stored in the Call channel.
 - The previous mode is restored.
 - When programming as an odd-split channel, press **[F]**, **[CALL]** (1 s) instead. “-” and “+” appear.

8

To use as an odd-split channel, proceed to the next step.

- 4 Turn the **Tuning** control, or press Mic **[UP]**/**[DWN]**, to select the desired transmit frequency.
- 5 Press **[CALL]** again.
 - The selected transmit frequency is stored in the Call channel, and the previous mode is restored.

Note:

- ◆ *Transmit Offset status and Reverse status are not stored in an odd-split Call channel.*
- ◆ *To store data other than frequencies, select the data in step 2 not step 4.*

MEMORY → VFO TRANSFERS

Transferring the contents of a memory channel or the Call channel to the VFO can be useful if you want to search for other stations or a clear frequency, near the selected memory channel or Call channel frequency.

- 1 Recall the desired memory channel or the Call channel.
- 2 Press **[F]**, **[VFO]**.
 - The entire contents of the memory channel or the Call channel are copied to the VFO. VFO mode is selected after the transfer is completed.

8

Note:

- ◆ A transmit frequency from an odd-split memory channel or odd-split Call channel is not transferred to the VFO. To transfer a transmit frequency, press **[REV]**, then press **[F]**, **[VFO]**.
- ◆ Lockout status and memory names are not copied from a memory channel to the VFO.

CHANNEL DISPLAY FUNCTION

When this function is switched ON, the transceiver displays only a memory channel number instead of a frequency.

Press **[LOW]+ POWER ON** to switch this function ON (or OFF).

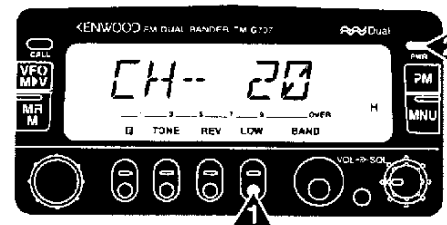

When in Channel Display mode, you cannot use the following functions:

- VFO Select
- Programmable Memory Recall
- Memory Channel Store
- Memory → VFO Transfer
- Freq. Step Size Change
- Easy Operation Select
- Programmable Memory Reset
- MHz Function Select
- Programmable Memory Store
- Call Channel Store
- Memory Channel Clear
- VFO Scan
- Partial/ Full reset

Note:

- ◆ You cannot switch this function ON if you have stored frequencies in no memory channels.
- ◆ When in Channel Display mode, you may want to recall only memory channels of the desired band. Before pressing **[LOW]+ POWER ON**, select "ONE" in Menu No. 4 (MR), then select the desired band.

INITIALIZING MEMORY

If your transceiver seems to be malfunctioning, initializing the transceiver may resolve the problem.

In addition, doing Full Reset is a quick way to clear all memory channels; however, you then need to re-program memory channels after initialization.

Note: While using the Channel Display or All Lock function, you cannot do Partial Reset nor Full Reset.

VHF Band Defaults

Version	VFO Frequency	Frequency Step	Tone Frequency
U.S.A./ Canada	144.000 MHz	5 kHz	88.5 Hz
Europe/ General	144.000 MHz	12.5 kHz	88.5 Hz

UHF Band Defaults

Version	VFO Frequency	Frequency Step	Tone Frequency
U.S.A./ Canada	440.000 MHz	25 kHz	88.5 Hz
Europe/ General	430.000 MHz	25 kHz	88.5 Hz

■ Partial Reset (VFO)

Use to initialize all settings except the memory channels, the Call channel, the PM channels, and Memory Channel Lockout.

1 Press [VFO]+ POWER ON.

- A confirmation message appears.



- To quit resetting, press any key other than [OK].

2 Press [OK].

■ Full Reset (Memory)

Use to initialize all settings that you have customized.

1 Press [MR]+ POWER ON.

- A confirmation message appears.

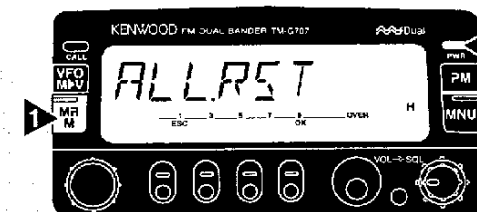

- To quit resetting, press any key other than [OK].

2 Press [OK].

Note: You can also do Partial Reset or Full Reset by pushing the RESET switch on the transceiver {page 73}.

PROGRAMMABLE MEMORY (PM)

Programmable Memory (PM) allows you to store virtually all settings currently set on the transceiver. So you can quickly recall exactly the same environment later. This transceiver provides 4 PM channels. If you are the type of person who likes the many features offered by modern transceivers, but dislikes remembering how to make all the necessary settings, you will find Programmable Memory particularly useful.

9

PROGRAMMABLE INFORMATION

The following programmable settings are shared by the VHF and UHF bands:

Band Select	Memory Recall method
Priority Scan method	Automatic Power Off
Time-Out Timer	Display Dimmer
Auto Dimmer Change	Beep volume
Data transfer rate	1750 Hz Tone Transmit Hold (TM-G707E only)
Scan resume method	S-meter Squelch
Microphone keypad confirmation tone (U.S.A./ Canada only)	

The following settings can be separately stored for the VHF and UHF bands:

VFO frequency	VFO mode
Memory Recall mode	Call Channel mode
Frequency step size	Transmit output power
Tone frequency	CTCSS frequency
Tone ON	CTCSS ON
Offset direction	Offset frequency
Automatic Repeater Offset	Reverse ON
Upper frequency limit (for Programmable VFO)	Lower frequency limit (for Programmable VFO)
Advanced Intercept Point	AM/ FM mode (U.S.A./ Canada only)

APPLICATION EXAMPLES

The following are examples of how you might use Programmable Memory. These examples may not represent applications useful to you, but you will understand the flexibility of this function.

Situation 1

You share your transceiver with other members in your family or club. However, each individual has personal preferences for how they like to set various functions. You have to keep changing many settings each time you use the transceiver.

Solution

Because 4 PM channels are available, up to 4 persons can separately program the transceiver and store their customized environment. Then each person can quickly change to his or her favorite settings, simply by recalling a PM channel. It is too much trouble to change back the settings after somebody else has reconfigured them. So this application may avoid having a feature-rich transceiver but never using many useful features.

Situation 2

While operating mobile on the way to work every morning, you prefer a silent transceiver that does not interrupt the morning calm. In addition, you feel that a bright display is a waste of electricity in sunlight. At night when driving home, you realize the Beep function truly serves a purpose and you acknowledge it is nice to see a bright display after dark.

Solution

In two PM channels, store the same operating data such as frequency, offset, tone, etc., and store different settings for the Display Dimmer and Beep functions. Then you can quickly recall the best settings for day or night operating.

Situation 3

You cannot figure out how you can make the transceiver exit the current mode.

Solution

Simply recall PM channel 1 that contains an exact copy of the transceiver default environment. You will not lose the contents of any memory channels.

STORING DATA IN PM CHANNELS

- 1 Confirm that the following conditions have been satisfied:
 - The transceiver is in the receive mode.
 - Scan is not being used.
 - Microphone Control is OFF.
- 2 Select the desired band.
- 3 Select the desired frequency and related data (Tone, CTCSS, etc.) using VFO mode.
- 4 If required, select another band, then select the desired frequency and related data.
- 5 Press **[F]**, **[PM]**.
 - The PM channel numbers appear and blink.

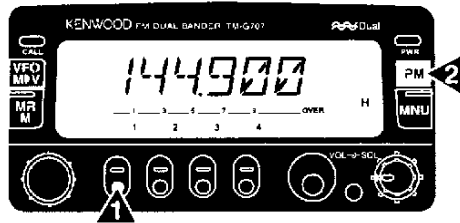

- 6 Press **[1]** to **[4]** corresponding to the desired PM channel.
 - The selected frequency and related data are stored in the PM channel.

RECALLING PM CHANNELS

- 1 Press **[PM]**.
 - The PM channel numbers appear.

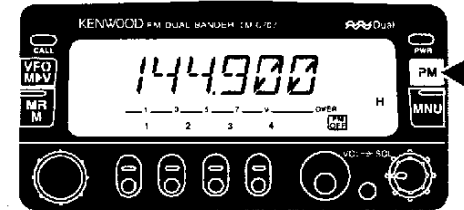

- 2 Press **[1]** to **[4]** corresponding to the desired PM channel.
 - The contents of the selected channel are recalled.
 - The selected channel number appears and slowly blinks.

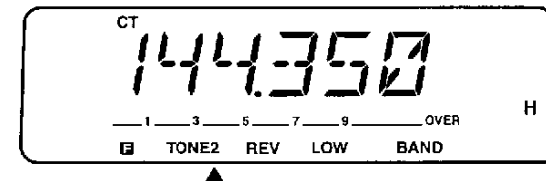

- To exit PM Recall mode, press **[PM]**, **[PM OFF]**.

Note: You cannot recall a PM memory channel while transmitting.

AUTO PM CHANNEL STORAGE

After you recalled a PM channel, this function automatically overwrites the current PM channel with the present operating environment when:

- You recall another PM channel.
- You press **[PM]**, **[PM OFF]**.
- You switch OFF the transceiver.

Use the following procedures to activate this function:

- 1 Press **[MNU]** to enter Menu mode.
- 2 Select Menu No. 6 (PM.AT).

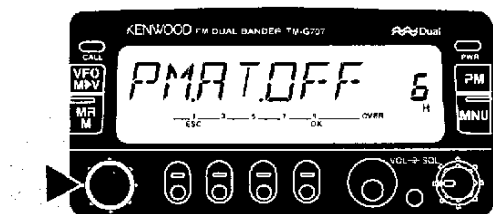

- 3 Press **[OK]**, then switch the function ON (or OFF).

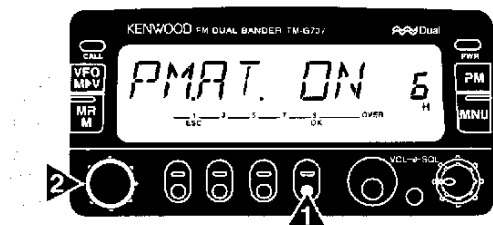

- 4 Press **[OK]** again to complete the setting and exit Menu mode.

RESETTING PROGRAMMABLE MEMORY

Use this procedure to reset the PM channels to the factory defaults.

- 1 Press **[CALL]+ POWER ON**.
 - A confirmation message appears.

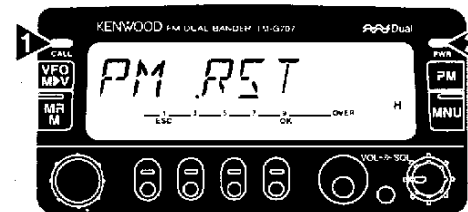

- To quit resetting, press any key other than **[OK]**.
- 2 Press **[OK]**.

9

SCAN

Scan is a useful feature for hands-off monitoring of your favorite frequencies. After becoming comfortable with how to use all types of Scan, the monitoring flexibility gained will increase your operating efficiency.

This transceiver provides the following conventional scans in addition to “Priority Scan” {page 44} that may be new to you:

10

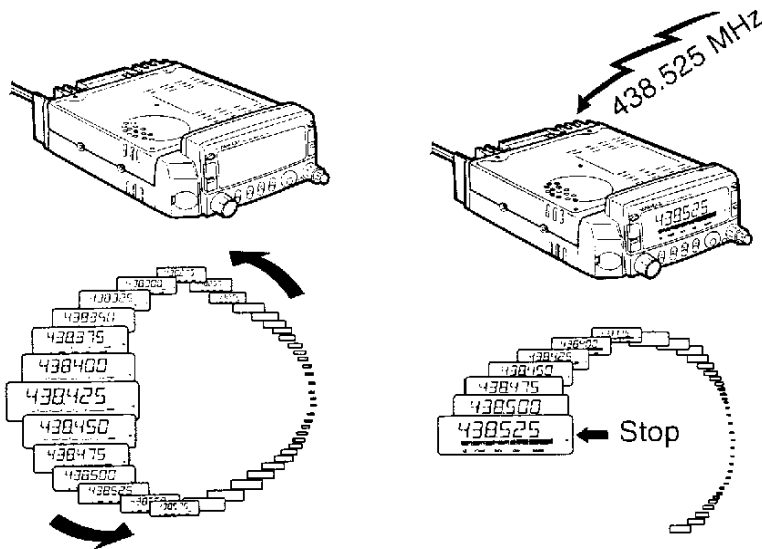

Scan Type	Scan Range
VFO Scan	All frequencies tunable on the band
Memory Scan	Frequencies stored in the memory channels
MHz Scan	All frequencies within 1 MHz range
Program Scan	All frequencies in the range selected on the band
Call/VFO Scan	Call channel plus the current VFO frequency
Call/Memory Scan	Call channel plus the memory channel last used

Note:

- ◆ Remember to adjust the squelch threshold level before using Scan.
- ◆ While using CTCSS, Scan stops for any signal received; however, the squelch opens only for signals that contain the same CTCSS tone that is selected on your transceiver.
- ◆ When using S-meter Squelch, Scan stops when the received signal strength matches or exceeds the S-meter setting. Scan resumes 2 seconds after the signal level drops below the S-meter setting.

SCAN RESUME METHODS

Before using Scans other than Priority Scan, it's necessary to decide under what condition you want your transceiver to continue scanning after detecting and stopping for a signal. You can choose Time-Operated mode or Carrier-Operated mode. The default is Time-Operated mode.

- **Time-Operated mode**

Your transceiver stops scanning when detecting a signal, remains there for approximately 5 seconds, and then continues to scan even if the signal is still present.

- **Carrier-Operated mode**

Your transceiver stops scanning when detecting a signal and remains on the same frequency until the signal drops out. There is a 2 second delay between signal drop-out and scan resumption to allow time for any responding stations to begin transmitting.

Note: To temporarily stop scanning and monitor weak signals, press and hold the Mic PF key assigned the Monitor function (page 51). Release the key to resume scanning.

■ Selecting Scan Resume Method

- 1 Press [MNU] to enter Menu mode.
- 2 Select Menu No. 10 (SCAN).



- 3 Press [OK], then select Time-Operated (default) or Carrier-Operated.

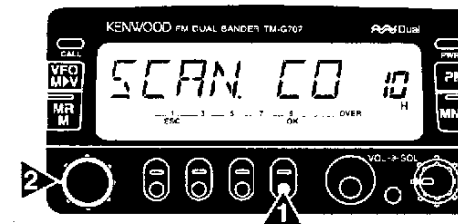

- 4 Press [OK] again to complete the setting and exit Menu mode.

10

VFO SCAN

VFO Scan allows you to scan all frequencies from the lowest frequency to the highest frequency on the band. The current frequency step size {page 55} is used.

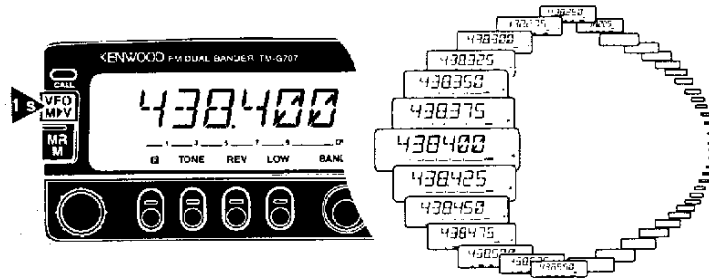

- 1 Select the desired band.
- 10 2 Press [VFO] (1 s).
 - The 1 MHz decimal blinks while scanning is in progress.
 - Scan starts at the frequency currently displayed.
 - To reverse the scan direction, turn the **Tuning** control clockwise (upward scan) or counterclockwise (downward scan), or press Mic [UP]/ [DWN].
- 3 To quit VFO Scan, press any key other than [MHz] and Mic [UP]/ [DWN].

Note: The squelch must be closed for Scan to function.

MEMORY SCAN

Memory Scan allows all memory channels containing data to be scanned.

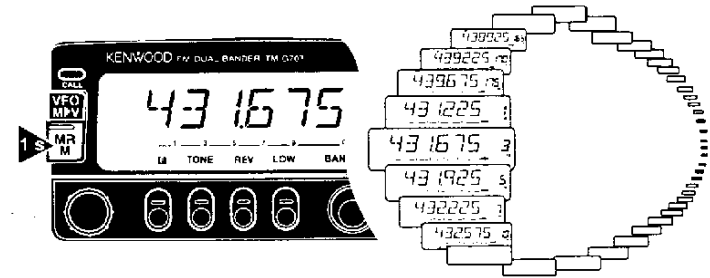

- 1 Press [MR] (1 s).
 - The 1 MHz decimal blinks while scanning is in progress.
 - Scan starts with the channel last recalled.
 - To reverse the scan direction, turn the **Tuning** control clockwise (upward scan) or counterclockwise (downward scan), or press Mic [UP]/ [DWN].
- 2 To quit Memory Scan, press any key other than Mic [UP]/ [DWN].

Note:

- ◆ At least 2 or more memory channels must contain data and must not be locked out.
- ◆ The squelch must be closed for Scan to function.
- ◆ The L1 to L6 and U1 to U6 memory channels and the priority channel are not scanned.
- ◆ You can also start Memory Scan when in Channel Display mode. While Scan is being interrupted, the channel number blinks.
- ◆ If you select "ONE" using Menu No. 4 (MR), memory channels on only the current band will be scanned; otherwise, memory channels on both VHF and UHF bands will be scanned.

■ Locking Out Memory Channels

Memory channels that you prefer not to monitor while scanning, can be locked out.

- 1 Recall the desired memory channel.
- 2 Press **[MNU]** to enter Menu mode.
- 3 Select Menu No. 3 (MR.L.O.).

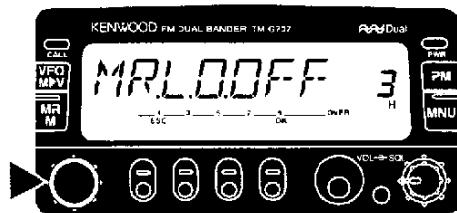

- 4 Press **[OK]**, then switch Lockout ON (or OFF).



- 5 Press **[OK]** again to complete the setting and exit Menu mode.

When you recall a locked out memory channel, a star appears above the memory channel.

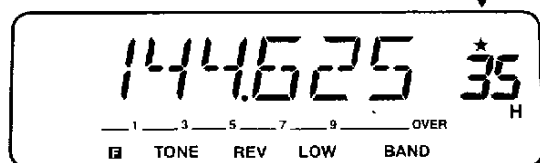

Note: The L1 to L6 and U1 to U6 memory channels and the priority channel cannot be locked out.

MHz SCAN

MHz Scan allows you to scan a 1 MHz segment of the band. The current 1 MHz digit determines the limits of the scan. For example, if the current frequency is 438.400 MHz, then MHz Scan would scan from 438.000 MHz to 438.975 MHz. The exact upper limit depends on the step size selected.

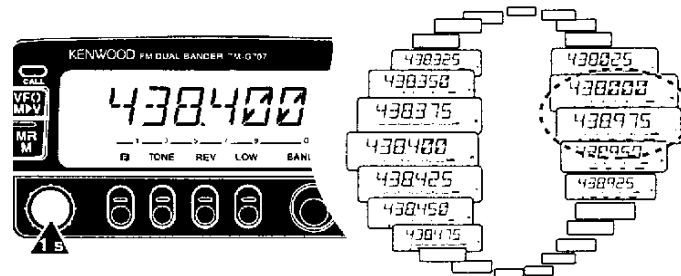

- 1 Select the desired band.
- 2 Press **[VFO]** (1 s) to start VFO Scan first.
- 3 Press **[MHz]** to start MHz Scan.
 - The 1 MHz decimal blinks while scanning is in progress.
 - Scan starts at the frequency currently displayed.
 - To reverse the scan direction, turn the **Tuning** control clockwise (upward scan) or counterclockwise (downward scan), or press Mic **[UP]**/ **[DWN]**.
- 4 To quit MHz Scan, press any key other than **[MHz]** and Mic **[UP]**/ **[DWN]**.

PROGRAM SCAN

Program Scan is identical with VFO Scan except that you select the frequency range of the scan.

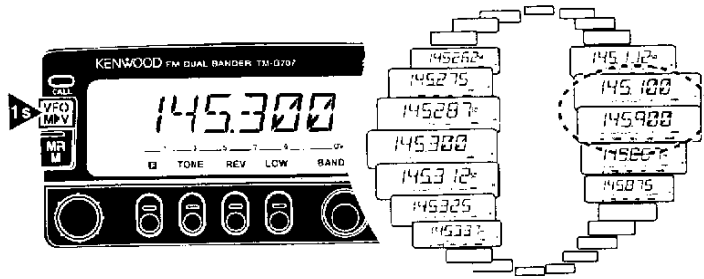

■ Setting Scan Limits

10

You can store up to 6 scan ranges in memory channels L1/U1 to L6/U6.

- 1 Select the desired band.
- 2 Select the desired frequency as the lower limit.
- 3 Press **[F]**.
- 4 Select a channel in the range from L1 to L6.



- 5 Press **[MR]**.
 - The lower limit is stored in the channel.
- 6 Select the desired frequency as the upper limit.
- 7 Press **[F]**.

- 8 Select a matching channel in the range from U1 to U6.
 - If you have selected, for example, L3 in step 4, select U3.

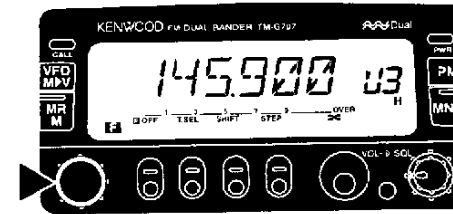

- 9 Press **[MR]**.
 - The upper limit is stored in the channel.
- 10 To confirm the stored scan limits, press **[MR]**, then select the L and U channels.

Note:

- ◆ The lower limit must be lower in frequency than the upper limit.
- ◆ The lower and upper frequency steps must be equal.
- ◆ The lower and upper limits must be selected on the same band.

■ Using Program Scan

- 1 Select a frequency equal to or between the programmed scan limits.
- 2 Press **[VFO] (1 s)**.
 - The 1 MHz decimal blinks while scanning is in progress.
 - Scan starts at the frequency currently displayed.
 - To reverse the scan direction, turn the **Tuning** control clockwise (upward scan) or counterclockwise (downward scan), or press Mic **[UP]/ [DWN]**.
- 3 To quit Program Scan, press any key other than **[MHz]** and Mic **[UP]/ [DWN]**.

Note:

- ◆ *The squelch must be closed for Scan to function.*
- ◆ *If the frequency step of the current VFO frequency differs from that of the programmed frequencies, you cannot use Program Scan.*
- ◆ *If the frequency steps of the lower limit and upper limit differ, you cannot use Program Scan.*
- ◆ *If the current VFO frequency is within more than one programmed scan range, the range stored in the smallest channel numbers is used.*

CALL/VFO SCAN

Use Call/VFO Scan to monitor both the Call channel and the current VFO frequency on the selected band.

- 1 Press **[VFO]** to select VFO mode.
- 2 Select the desired band.
- 3 Select the desired frequency.
- 4 Press **[CALL] (1 s)** to start Call/VFO Scan.
 - The 1 MHz decimal blinks while scanning is in progress.
- 5 To quit Call/VFO Scan, press any key other than Mic **[UP]/ [DWN]**.

10

CALL/MEMORY SCAN

Use Call/Memory Scan to monitor both the Call channel and the desired memory channel.

- 1 Recall the desired memory channel.
- 2 Press **[CALL] (1 s)** to start Call/Memory Scan.
 - The 1 MHz decimal blinks while scanning is in progress.
 - The Call channel on the same band as of the selected memory channel is used for Scan.
- 3 To quit Call/Memory Scan, press any key other than Mic **[UP]/ [DWN]**.

Note: *The memory channel last used is scanned even if it has been locked out.*

PRIORITY SCAN

You may sometimes want to monitor your favorite frequency on one band while operating on another band. Use Priority Scan. This Scan always monitors your favorite frequency in the background. When receiving signals on your specific frequency, the transceiver immediately recalls that frequency on the display and allows you to use it for QSO. First store your favorite frequency in the Priority channel and select one of the two Priority Scan methods.

Note: If you do not operate any control or key for 3 seconds after signals drop, the transceiver resumes Priority Scan.

10

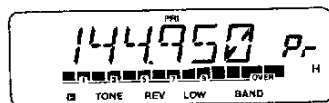
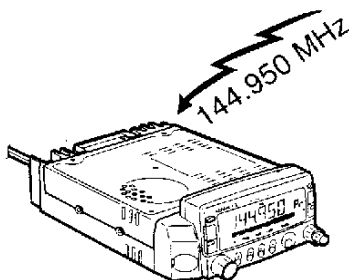
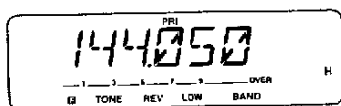
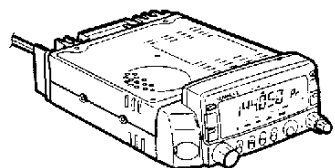

■ Storing Frequency in Priority Channel

- 1 Select the desired band.
- 2 Select the desired frequency.
- 3 Press **[F]**.
 - A memory channel number appears.
- 4 Select the Priority channel ("Pr").

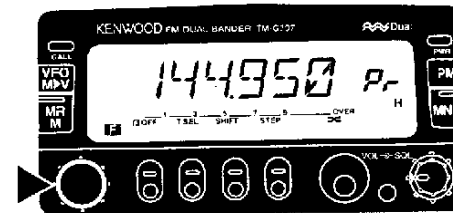

- 5 Press **[MR]**.

Note: Not only can you store data in the Priority channel, but you can also overwrite existing data with new data.

■ Selecting Priority Scan Method

This transceiver prepares the following two modes for Priority Scan. Use mode B when you do not want Priority Scan to disrupt your current QSO.

Mode A: Monitors the Priority channel every 3 seconds no matter whether or not signals are being received on the current operating frequency.

Mode B: Monitors the Priority channel every 3 seconds only when no signals are present on the current operating frequency.

- 1 Press **[MNU]** to enter Menu mode.
- 2 Select Menu No. 11 (PRI).

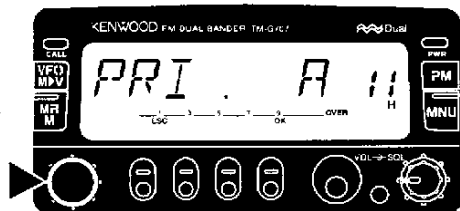

- 3 Press **[OK]**, then select mode A (default) or mode B.

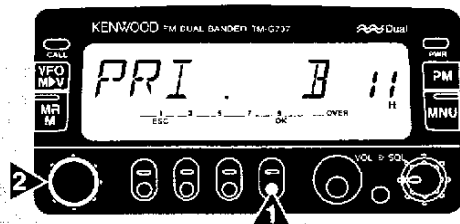

- 4 Press **[OK]** again to complete the setting and exit Menu mode.

■ Using Priority Scan

- 1 Press **[F]**, **[MNU]** to start Priority Scan.
 - “PRI” appears.



- When signals are received on the Priority channel, a beep sounds and the Priority channel is recalled. In addition, “PRI” blinks.

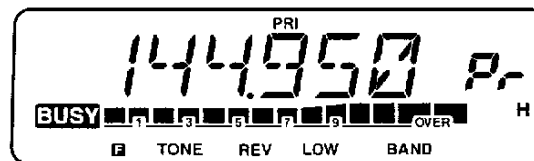

10

- 2 Press and hold Mic **[PTT]** to transmit on the Priority channel and release Mic **[PTT]** to receive.
 - Approximately 3 seconds after signals drop, Priority Scan resumes.
- 3 To quit Priority Scan, press **[F]**, **[MNU]** again.

Note:

- ◆ When signals are received on the Priority channel programmed with CTCSS, the Priority channel is recalled; however, the squelch does not open unless the signals contain the matching CTCSS tone.
- ◆ You can simultaneously use Priority Scan and any other type of Scan; however Priority Scan does not function while the other scan is being paused.
- ◆ To monitor the current operating frequency while using Priority Scan, press and hold the Mic PF key assigned the Monitor function (page 51). Release the key to resume Priority Scan.

CONTINUOUS TONE CODED SQUELCH SYSTEM (CTCSS)

You may sometimes want to hear calls from only specific persons. The Continuous Tone Coded Squelch System (CTCSS) allows you to ignore (not hear) unwanted calls from other persons who are using the same frequency. Simply select the same CTCSS tone as selected by the other persons in your group. A CTCSS tone is subaudible and is selectable from among the 38 standard tone frequencies.

Note: CTCSS does not cause your conversation to be private. It only relieves you of listening to unwanted conversations.

USING CTCSS

- 1 Select the desired band.
- 2 Press **[TONE]** to activate the CTCSS function.
 - Each time you press **[TONE]**, the selection changes as shown below:

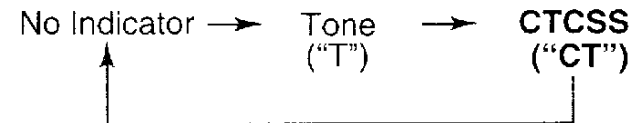

- 3 Press **[F]**, **[T.SEL]**.
 - The current CTCSS frequency appears and blinks.

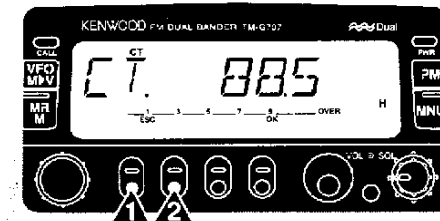

- 4 Turn the **Tuning** control, or Mic **[UP]**/ **[DWN]**, to select a CTCSS frequency.
- 5 Press **[OK]** to complete the setting.
- 6 **When you are called:**

The squelch of your transceiver opens only when the selected tone is received.

When you make a call:

Press and hold Mic **[PTT]**.

11

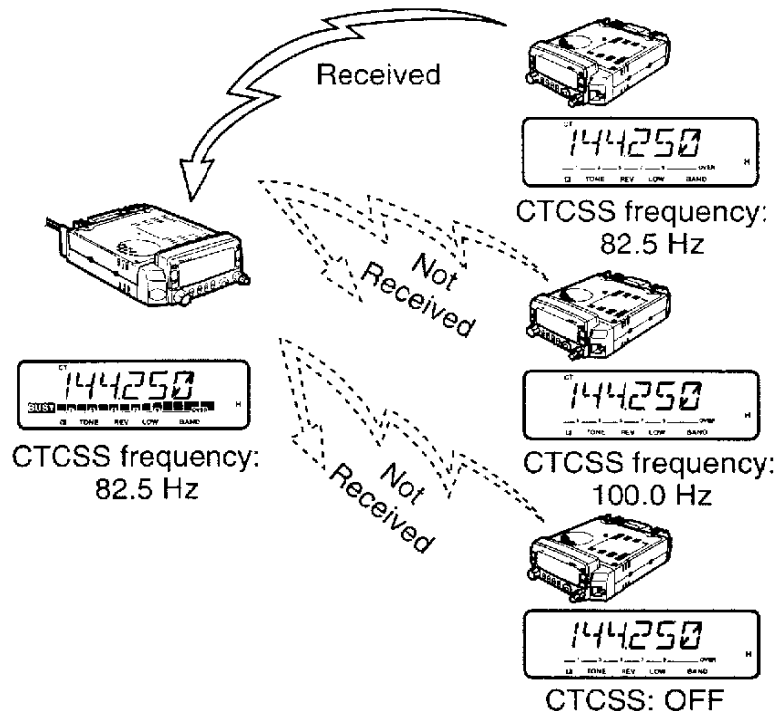

Note:

- ◆ Skip steps 3 to 5 if you have already programmed the appropriate CTCSS frequency.
- ◆ You can select a separate tone frequency for the CTCSS and Tone functions.
- ◆ You cannot use the CTCSS and Tone functions simultaneously.
- ◆ If you select a high tone frequency, receiving audio or noise that contains the same frequency portions may cause CTCSS to function incorrectly. To prevent noise from causing this problem, select an appropriate noise squelch level (page 15).

No.	Freq. (Hz)	No.	Freq. (Hz)	No.	Freq. (Hz)	No.	Freq. (Hz)
01	67.0	11	97.4	21	136.5	31	192.8
02	71.9	12	100.0	22	141.3	32	203.5
03	74.4	13	103.5	23	146.2	33	210.7
04	77.0	14	107.2	24	151.4	34	218.1
05	79.7	15	110.9	25	156.7	35	225.7
06	82.5	16	114.8	26	162.2	36	233.6
07	85.4	17	118.8	27	167.9	37	241.8
08	88.5	18	123.0	28	173.8	38	250.3
09	91.5	19	127.3	29	179.9		
10	94.8	20	131.8	30	186.2		

Note: Use Nos. 01 to 38, shown in the table above, when selecting tone frequencies via Keypad Direct Entry (page 55) (U.S.A./ Canada only).

■ Automatic Tone Frequency ID

This function automatically identifies the incoming tone frequency on a received signal.

- 1 Select the desired band.
- 2 Press **[TONE]** (1 s) to activate the function.
 - The current tone frequency appears and the 1 Hz decimal blinks.

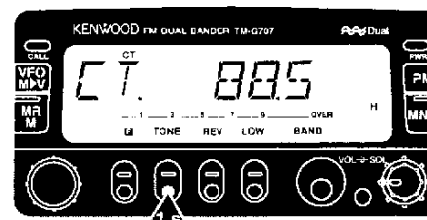

- When a signal is received, the transceiver begins scanning through all tone frequencies in order to identify the incoming tone frequency.
- When the tone frequency is identified, the identified frequency appears and blinks.

11

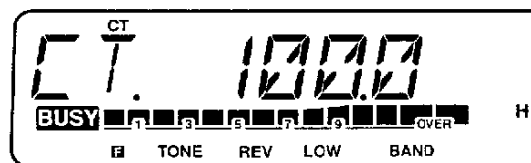

- The identified frequency is programmed in place of the currently set CTCSS frequency.

- 3 Press any key to quit the function.

Note: Received signals are audible while scanning is in progress.

DUAL TONE MULTI-FREQUENCY (DTMF) FUNCTIONS (U.S.A./ CANADA ONLY)

You can send DTMF tones by using the DTMF keys on the MC-53DM microphone. The keypad includes the 12 keys found on a push-button telephone plus 4 additional keys (A, B, C, D). These additional keys are required for various control operations by some repeater systems.

MAKING DTMF CALLS

- 1 Press and hold Mic [PTT].
- 2 Press the keys in sequence on the keypad to send DTMF tones.

12

- The corresponding DTMF tones are transmitted.
- Your transceiver remains in the transmit mode for 2 seconds after you release each key. So you can release Mic [PTT] after beginning to press keys.

Freq. (Hz)	1209	1336	1477	1633
697	1	2	3	A
770	4	5	6	B
852	7	8	9	C
941	*	0	#	D

■ Autopatch

Some repeaters in the U.S.A. and Canada offer a service called Autopatch. Autopatch allows you to access the public telephone network by sending DTMF tones. Some repeaters require a special key sequence to activate Autopatch. Check with the repeater control operator.

■ Mic Keypad Confirmation Tones

When pressing the desired keys on the microphone keypad, this function produces feedback tones for your confirmation.

- 1 Press [MNU] to enter Menu mode.
- 2 Select Menu No. 28 (DT.MN).

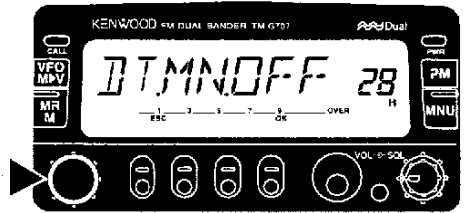

- 3 Press [OK], then turn the **Tuning** control to switch the function ON or OFF (default).
- 4 Press [OK] again to complete the setting and exit Menu mode.

STORING DTMF NUMBERS FOR AUTOMATIC DIALER

To store a DTMF number with a maximum of 16 digits in any of 10 dedicated DTMF memory channels, follow the procedure below.

Note: Audible DTMF tones from other transceivers near you may be picked up by your microphone. If so, this could prevent the function from working correctly.

- 1 Press **[MNU]** to enter Menu mode.
- 2 Select Menu No. 29 to 38 (DTMF) corresponding to the desired memory channel.

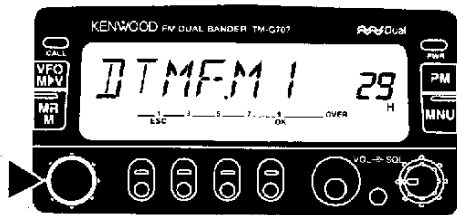

- 3 Press **[OK]**.
 - The display for entering a DTMF number appears.

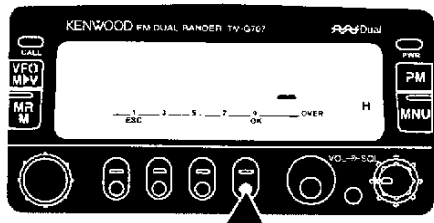

- 4 Use the keypad to enter the digits of the number to be stored.
 - The corresponding DTMF tones are heard.
 - If you enter an incorrect digit, press **[VFO]** to erase all digits entered.
- 5 Press **[OK]** to complete the entry and exit Menu mode.

CONFIRMING STORED DTMF NUMBERS

- 1 Press **[MNU]** to enter Menu mode.
- 2 Select Menu No. 29 to 38 (DTMF) corresponding to the desired memory channel.
- 3 Press **[MR]**.
 - The number stored in the channel scrolls across the display accompanied by DTMF tones from the speaker.
- 4 Press **[MNU]** to exit Menu mode.

TRANSMITTING STORED DTMF NUMBERS

To transmit a stored DTMF number, follow the procedure below.

- 1 Press Mic **[PTT]**+ Mic **[PF]**.

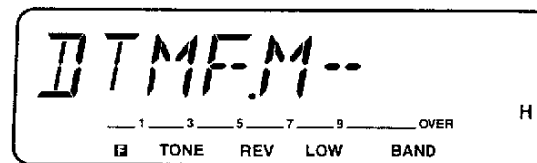

- 2 Press a single key **[0]** to **[9]** to select the desired channel.
 - The number stored in the channel scrolls across the display accompanied by DTMF tones from the speaker.
 - After the transmission, the frequency display is restored.

PROGRAMMABLE FUNCTION (PF) KEYS

The Programmable Function keys are [PF], [MR], [VFO], and [CALL] located on the face of the microphone. If you prefer, you can change the default functions assigned to these keys.

Programmable Function Key	Default Function
[PF] (PF1)	Band Select
[MR] (PF2)	Memory Recall
[VFO] (PF3)	VFO Select
[CALL] (PF4)	Call Channel Select

13

ASSIGNING FRONT PANEL KEY FUNCTIONS

- 1 Press one of the following key combinations depending on which key you want to re-program:

Mic [PF]+ POWER ON (“PF1” appears)

Mic [MR]+ POWER ON (“PF2” appears)

Mic [VFO]+ POWER ON (“PF3” appears)

Mic [CALL]+ POWER ON (“PF4” appears)

- 2 Press the key or key combination on the front panel that you want to assign.

- The following types of front panel key functions cannot be assigned:

PWR switch	[KEY]+ POWER ON	[F]
[KEY] (1 s)	Tuning control	VOL control
SQL control		

- The front panel key will still function normally after “copying” its function to a Programmable Function key.
- To restore the default functions, do a Full Reset {page 33}.

Note:

- ◆ If the **LOCK** switch located on the rear of the microphone is ON, you cannot re-program the Programmable Function keys.
- ◆ Pressing the **PTT** switch in step 2 assigns the VFO/Memory Recall Switch function.

ASSIGNING SPECIAL KEY FUNCTIONS

- 1 Press **[MNU]** to enter Menu mode.
- 2 Select Menu No. 20 (PF1) to No. 23 (PF4).

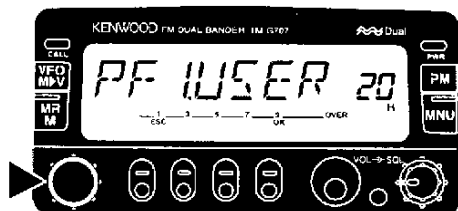

- 3 Press **[OK]**, then turn the **Tuning** control to select the desired function.
 - As you turn the **Tuning** control clockwise the selection changes as shown below:
User Setting → Monitor → Enter (U.S.A./ Canada only)
→ Voice → PWR switch (PF 1 only) → 1750 Hz Tone (TM-G707E only)
- 4 Press **[OK]** again to complete the setting and exit Menu mode.

User Setting:

Selects the front panel key function you assigned {page 50}.

Monitor:

Makes the squelch open and allows you to monitor activity on the current frequency. This function is useful when adjusting the volume or when receiving weak signals.

- Pressing the re-programmed Mic key switches Monitor ON or OFF.
- Scan will not function if Monitor is ON (squelch open).

Enter (U.S.A./ Canada only):

Allows you to enter digits from the MC-53DM microphone. Refer to "KEYPAD DIRECT ENTRY" {page 54}.

Voice:

Activates or deactivates the function that announces the current frequency using beeps of different frequencies. Press any key to stop the beeps.

PWR switch:

Turns the transceiver ON or OFF. This function can be assigned only to PF 1.

1750 Hz Tone (TM-G707E only):

Activates the Tone Function and transmits a 1750 Hz tone while you are holding down the re-programmed Mic key. You need not press Mic **[PTT]**.

- You can also use Transmit Hold to continuously send a 1750 Hz tone for 2 seconds after releasing the re-programmed Mic key. To activate this function, access Menu No. 26 (T.HLD) and select ON.

AUXILIARY FUNCTIONS

TIME-OUT TIMER (TOT)

It is sometimes necessary or desirable to restrict a single transmission to a specific maximum time. This feature can be useful when accessing repeaters to prevent repeater time-outs, or when trying to conserve battery power.

When TOT times out, the transceiver generates beeps and automatically returns to receive mode. To resume transmitting, release and then press Mic [**PTT**] again.

You can change the default TOT time (10 minutes).

- 1 Press [**MNU**] to enter Menu mode.
- 2 Select Menu No. 13 (TOT).



- 3 Press [**OK**], then turn the **Tuning** control to select the desired TOT time.
 - The selectable time are 3, 5, and 10 minutes.
- 4 Press [**OK**] again to complete the setting and exit Menu mode.

AUTOMATIC POWER OFF (APO)

Automatic Power Off is a background function that monitors whether any buttons or keys have been pressed, or whether the **Tuning** control has been turned. After 3 hours pass with no operations, APO turns OFF the power. However, 1 minute before the power turns OFF, "APO" appears and blinks, and a series of warning tones sound.

Note: If the squelch opens or any settings are changed during the 3 hour period while APO is ON, the timer resets. When the squelch closes or you stop changing the settings, the timer begins counting again from 0.

- 1 Press [**MNU**] to enter Menu mode.
- 2 Select Menu No. 12 (APO).

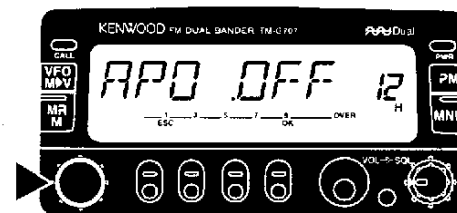

- 3 Press [**OK**], then turn the **Tuning** control to switch the function ON (or OFF).
- 4 Press [**OK**] again to complete the setting and exit Menu mode.

PROGRAMMABLE VFO

If you want, you can set limits for the minimum and maximum frequencies that are selectable using the **Tuning** control. For example, if you select 145 MHz for the lower limit and 146 MHz for the upper limit, the tunable range will be from 145.000 MHz to 146.995 MHz. This function will be useful if you always check frequencies within a certain range.

Note:

- ◆ You cannot program the 100 kHz and subsequent digits.
- ◆ The exact 100 kHz and subsequent digits of the upper limit depend on the step size selected.
- ◆ You can select the lower and upper limits within the allowable receive frequency range that differs depending on the markets.

- 1 Press **[VFO]** to select VFO mode.
- 2 Select the desired band.
- 3 Press **[MNU]** to enter Menu mode.
- 4 Select Menu No. 9 (PROG.VFO).

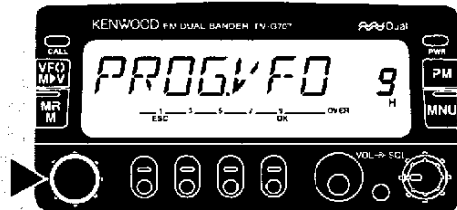

- 5 Press **[OK]**, then select the lower frequency limit.

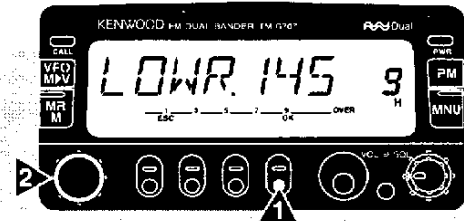

- 6 Press **[OK]** again, then select the upper frequency limit.

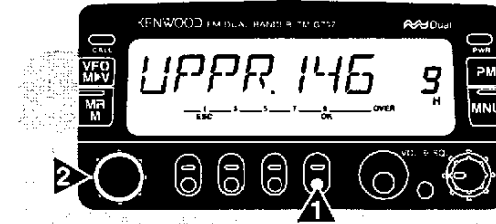

- 7 Press **[OK]** once again to complete the setting and exit Menu mode.

KEYPAD DIRECT ENTRY (U.S.A./ CANADA ONLY)

You can select the desired operating frequency, memory channel, or tone frequency by entering numbers directly from the MC-53DM microphone. To use this function, assign the Enter function to any Programmable Function key first {page 51}.

■ Frequency Entry

- 1 Press **[VFO]** to select VFO mode.
- 2 Select the desired band.
- 3 Press the Mic key re-programmed with Enter.
 - The display for Direct Frequency Entry appears.

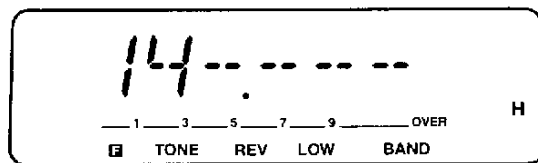

- 4 Use the Mic keypad to enter the desired frequency.
 - Enter the digits in order from the most significant to the least significant.
 - When the current step size is 5, 10, 15, 20, or 50 kHz, enter numeric values to the 1 kHz digit. Enter either 0 or 5 for the 1 kHz digit.
 - On versions with receiver coverage wider than 10 MHz, enter from the 10 MHz digit. For other versions, begin entering from the 1 MHz digit.

Note:

- ◆ When the current step size is 6.25, 12.5, or 25 kHz, entering the 10 kHz digit completes frequency setting. The 10 kHz and subsequent digits are corrected according to which key is pressed for the 10 kHz digit.
- ◆ If you press any key other than **[0] ~ [9]** or **[Enter]**, or if you do not make the next entry within 10 seconds, direct entry is canceled and the VFO mode is restored.
- ◆ If you press Mic **[Enter]** while entering a frequency, the new data is accepted for the digits entered and the previous data remains unchanged for the digits not yet entered.
- ◆ Except for the 1 kHz digit, entering a digit that is outside the allowable range causes the nearest digit within range to be displayed. For the 1 kHz digit, pressing **[0] ~ [4]** selects "0" and pressing **[5] ~ [9]** selects "5".

■ Memory Channel Number Entry

- 1 Press **[MR]** to enter Memory Recall mode.
- 2 Press the Mic key re-programmed with Enter.
 - "1 - -" appears.

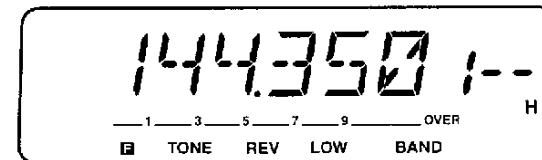

- 3 Use the Mic keypad to enter 3 digits.
 - To recall channel 3, for example, enter "003".
 - If you press any key other than **[0] ~ [9]**, or if you do not make the next entry within 10 seconds, the previous frequency display will be restored.
 - If you enter a memory channel that does not contain data, an error beep sounds.

■ Tone Frequency Number Entry

- 1 Select the desired band.
- 2 Press **[TONE]** to activate the Tone or CTCSS function.
- 3 Press **[F]**, **[T.SEL]**.
 - The current tone frequency appears.
- 4 Press the Mic key re-programmed with Enter.
 - “- -” appears.

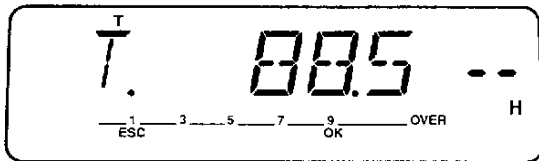

- 5 Use the Mic keypad to enter the Tone No. corresponding to the desired tone frequency.
 - Consult the tables given in pages 24 and 47 to find out how the Tone Nos. correspond to the tone frequencies.
 - To select Tone No. 3 (74.4 Hz), for example, enter “03”.
 - If you press any key other than **[0]** ~ **[9]**, or if you do not make the next entry within 10 seconds, the previous frequency display will be restored.

CHANGING FREQUENCY STEP SIZE

Choosing the correct step size is essential in order to select your exact receive frequency using the **Tuning** control or Mic **[UP]/ [DWN]**. The default step size on the VHF band is 5 kHz (U.S.A./ Canada) or 12.5 kHz (Europe/ General). The default on the UHF band is 25 kHz no matter which market version.

- 1 Press **[VFO]** to select VFO mode.
- 2 Select the desired band.
- 3 Press **[F]**, **[STEP]**.
 - The current step size appears.

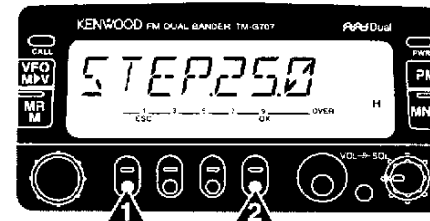

- 4 Turn the **Tuning** control, or press Mic **[UP]/ [DWN]**, to select the desired step size.
 - The selectable step sizes are 5, 6.25, 10, 12.5, 15, 20, 25, and 50 kHz.
- 5 Press **[OK]** to complete the setting.

Note: Changing between step sizes may correct the displayed frequency. For example, if 144.995 MHz is displayed with a 5 kHz step size selected, changing to a 12.5 kHz step size corrects the displayed frequency to 144.975 MHz.

14

DISPLAY DIMMER

■ Manual Dimmer Change

You can manually change the display illumination to suit the lighting conditions where you are operating.

Press **[DIM]** to select from 5 levels, including OFF.

Note: Selecting OFF automatically switches Auto Dimmer Change ON.

■ Auto Dimmer Change

This function increases the display intensity one step brighter for approximately 5 seconds when you press a front panel button or Mic key, or turn the **Tuning** control. No change occurs if you have selected the brightest level.

- 1 Press **[MNU]** to enter Menu mode.
- 2 Select Menu No. 2 (A.DIM).

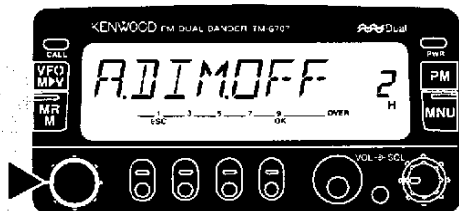

- 3 Press **[OK]**, then turn the **Tuning** control to switch the function ON (or OFF).
- 4 Press **[OK]** again to complete the setting and exit Menu mode.

BEEP VOLUME CHANGE

The transceiver beeps each time you press a front panel button or Mic key. You can change the beep volume or turn it off.

- 1 Press **[MNU]** to enter Menu mode.
- 2 Select Menu No. 16 (BEEP).



- 3 Press **[OK]**, then turn the **Tuning** control to select the volume from levels 1 to 7 and OFF.
 - The default is level 5.
- 4 Press **[OK]** again to complete the setting and exit Menu mode.

DISPLAY DEMONSTRATION

By initiating this function, various pre-programmed displays appear. You still can normally use the transceiver in this mode. Pressing a front panel button or Mic key, or turning the **Tuning** control restores the operating display immediately. If there is no button/key entry or **Tuning** control adjustment for approximately 12 seconds, the transceiver reverts back to Demonstration mode.

Press **[F]+ POWER ON** to switch the function ON (or OFF).

LOCK

■ Transceiver Lock

Transceiver Lock is suitable for a typical mobile installation where you alter most functions with your microphone. This Lock disables all functions excluding the following:

- **PWR** switch
- **[F]**, **[MHz]**
- **VOL** controls
- **[F]**
- **SQL** controls
- Microphone keys

Press **[F]**, **[MHz]** to switch Transceiver Lock ON (or OFF).

- A key icon appears when the function is ON.

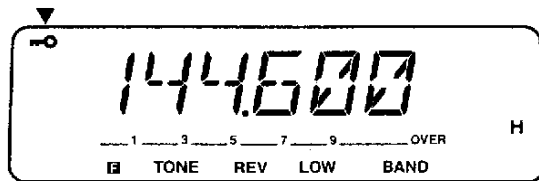

■ All Lock

All Lock is ideal when you have no plans to transmit but you want to monitor a specific channel. This Lock disables all functions excluding the following two:

- **PWR** switch
- **[MHz]+ POWER ON**

- 1 Switch Transceiver Lock ON.
- 2 Switch OFF the power to the transceiver.
- 3 Press **[MHz]+ POWER ON** to switch All Lock ON (or OFF).
 - The key icon slowly blinks when the function is ON.

POWER-ON MESSAGE

Each time you switch the transceiver ON, the factory-default message appears and stays for approximately 2 seconds. You can program your favorite message in place of "KENWOOD".

- 1 Press **[MNU]** to enter Menu mode.
- 2 Select Menu No. 1 (P-ON).

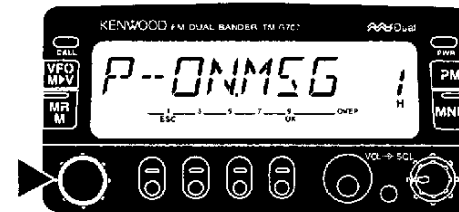

- 3 Press **[OK]**.
 - The current message appears and the last digit blinks.
- 4 Press **[VFO]** to clear all digits and move back to the first digit.
- 5 Turn the **Tuning** control, or press Mic **[UP]/ [DWN]**, to select the first digit.
 - To enter a dot after the digit, press **[MR]**. Pressing **[MR]** again clears the dot.
- 6 Press **[▶]**.
 - The second digit blinks.
- 7 Repeat steps 5 and 6 to enter up to 7 digits.
 - After entering the 7th digit, you need not press **[▶]**.
 - To re-enter the preceding digit, press **[◀]**.
- 8 Press **[OK]** again to complete the setting and exit Menu mode.

S-METER SQUELCH

By activating S-meter Squelch, the squelch does not open until a signal with the same or greater strength than the S-meter setting is received. This function is useful to eliminate constantly resetting the squelch when receiving weak stations that you have no interest in.

- 1 Press **[MNU]** to enter Menu mode.
- 2 Select Menu No. 14 (S.SQL).

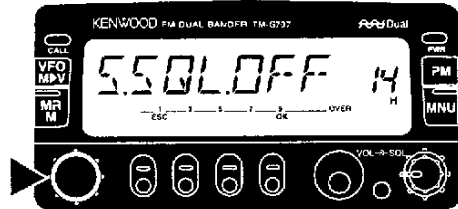

- 3 Press **[OK]**, then turn the **Tuning** control to switch the function ON (or OFF).
- 4 Press **[OK]** again to complete the setting and exit Menu mode.
 - The S-meter setting segments appear.

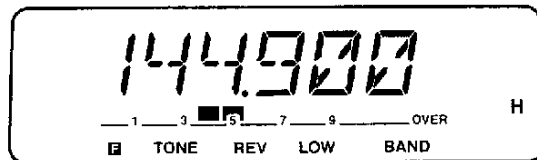

- 5 Turn the **SQL** control to select the desired S-meter setting from the 7 levels.

Squelch Hang Time

When using S-meter Squelch, you may want to adjust the time interval between when the received signals drop and when the squelch closes.

- 1 Press **[MNU]** to enter Menu mode.
- 2 Select Menu No. 15 (HNG.T).

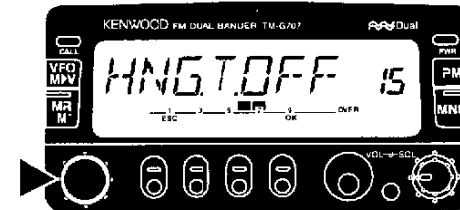

- 3 Press **[OK]**, then turn the **Tuning** control to select from OFF (default), 125 ms, 250 ms and 500 ms.
- 4 Press **[OK]** again to complete the setting and exit Menu mode.

Note: Menu No. 15 is selectable only when the S-meter Squelch is ON.

ADVANCED INTERCEPT POINT (AIP)

AIP helps eliminate interference and reduce audio distortion caused by intermodulation. This problem is often apparent in urban areas when the band is extremely crowded.

- 1 Select the desired band.
- 2 Press **[F]**, **[DIM]** to switch the function ON (or OFF).
 - “AIP” appears when the function is selected.

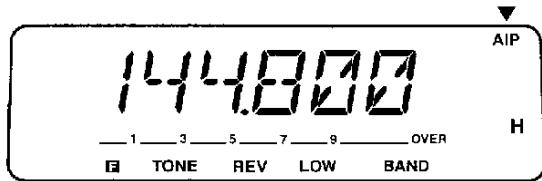

Note: You can make a separate AIP setting between the VHF and UHF bands.

SWITCHING AM/FM MODE (U.S.A./ CANADA ONLY)

This transceiver is also capable of receiving in AM mode. The default mode for the 118 MHz band is AM; the default for the 144 MHz or 440 MHz band is FM. You can select either mode for each band.

Note: The AM mode is available to receive only. You cannot use AM mode to transmit.

- 1 Select the desired band.
- 2 Press **[MNU]** to enter Menu mode.
- 3 Select Menu No. 0 (F/A).

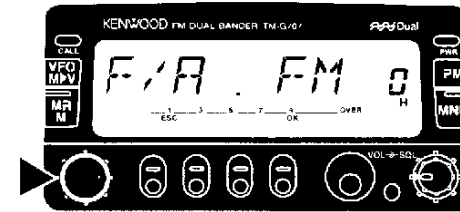

- 4 Press **[OK]**, then select FM or AM mode.

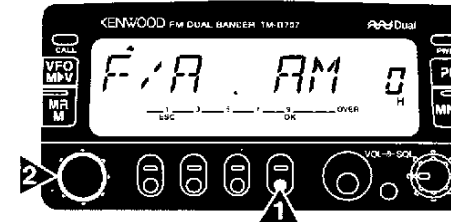

- 5 Press **[OK]** once again to complete the setting and exit Menu mode.

When you select AM mode, a spade icon appears.

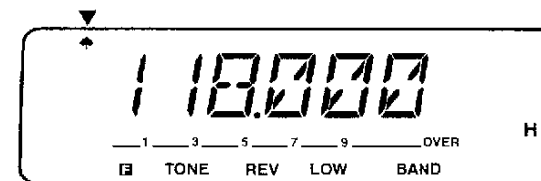

MICROPHONE CONTROL (U.S.A./ CANADA ONLY)

You can change numerous transceiver settings by using the MC-53DM microphone keys. DTMF tones are used for this remote control operation. First switch Microphone Control ON using Menu Set-up.

Note:

- ◆ Audible DTMF tones from other transceivers near you may be picked up by your MC-53DM microphone. If so, this could prevent the function from working correctly.
- ◆ **U.S.A. only:** It is illegal to transmit control codes on the VHF band. Transmit control codes only on the UHF band.

- 1 Press **[MNU]** to enter Menu mode.
- 2 Select Menu No. 27 (MC.RM).

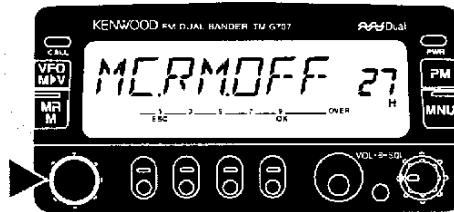

15

- 3 Press **[OK]**, then turn the **Tuning** control to switch the function ON (or OFF).
- 4 Press **[OK]** again to complete the setting and exit Menu mode.

The following table shows what function is switched ON and OFF or which setting is changed. For the shaded items, press **[D]** first (ex. **[D]** then **[2]**).

Key	Function	Key	Function
1	Priority Scan	B	Dimmer Level Change
2	Tone/ CTCSS	C	—
3	Reverse	D	[F] key
4	1 MHz Step Change	*	Down ⁴
5	Monitor	#	Up ⁴
6	Frequency Readout by Beeps ¹	2	Tone Select ^{2, 5, 6}
7	Volume Change ^{2, 3}	3	Offset Direction Select
8	Cross-band Operation	5	DTMF Keypad Lock
9	Squelch Adjustment ^{2, 3}	6	DTMF Keypad Unlock
0	TX Power Change	0	Frequency Step Change ^{2, 6}
A	Enter	B	AIP

- ¹ Transceivers equipped with the optional VS-3 unit announce the displayed information {page 63}.
- ² After entering the selection mode, press **[*]** or **[#]** to change the level or selection.
- ³ Both Volume Change and Squelch Adjustment cannot be activated at the same time.
- ⁴ Both Volume Change and Squelch Adjustment must be OFF to change the tone or frequency step using this key.
- ⁵ First press **[2]** to activate the Tone or CTCSS function.
- ⁶ Press **[OK]** on the front panel of the transceiver to complete the setting.

PACKET OPERATION

Connect this transceiver to your personal computer via a Terminal Node Controller (TNC) {page 6}. You can send E-mail to far away stations or obtain a variety of information via your local bulletin boards, or you may enjoy other Packet applications. Reference material for starting Packet operation should be available at any store that handles Amateur Radio equipment.

1200/ 9600 bps OPERATION

Select 1200 bps or 9600 bps for the data transfer rate, depending on the type of your TNC.

1200 bps:

The Transmit data input (PKD) sensitivity is $40 \text{ mV}_{\text{P-P}}$, and the input impedance is $10 \text{ k}\Omega$. This is suitable for a typical 1200 bps TNC.

9600 bps:

The Transmit data input (PKD) sensitivity is $2 \text{ V}_{\text{P-P}}$, and the input impedance is $10 \text{ k}\Omega$. This is suitable for most 9600 bps TNCs. Select 9600 bps if using a TNC with dual speed capability that only has a $2 \text{ V}_{\text{P-P}}$ output.

- 1 Press [MNU] to enter Menu mode.
- 2 Select Menu No. 19 (BPS).

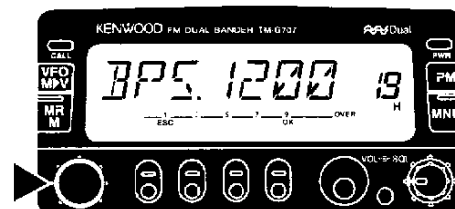

- 3 Press [OK], then switch 1200 bps (default) or 9600 bps.

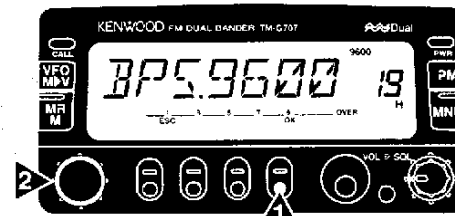

- 4 Press [OK] again to complete the setting and exit Menu mode.

If you select 9600 bps, "9600" appears.

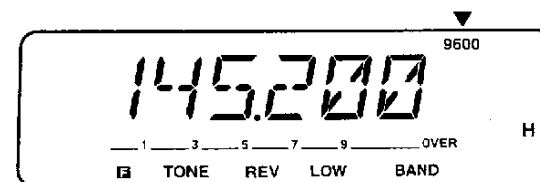

Note:

- ◆ If the TX delay of your TNC is not long enough, connection errors may occur. If connection errors frequently occur, it is recommended to set the TX delay parameter on the TNC to 300 ms by using your computer.
- ◆ Using a modulator input level that is far different from the optimum 40 mV_{P-P} or 2 V_{P-P} specifications may result in deterioration of the S/N ratio or signal distortion. This could result in increased errors or a complete failure to connect with other stations.
- ◆ If the modulator input level exceeds approximately 3 V_{P-P}, the limiter circuit functions to maintain the same transmit bandwidth as that of 3 V_{P-P}.
- ◆ Packet operation, easily affected by transmit and receive conditions, requires a full-scale S-meter reading for reliable communication. When the S-meter reads less than maximum during 9600 bps operation, communication errors are frequent.
- ◆ Inputting 9600 bps GMSK signals at too high a level or inputting significantly distorted signals into the transceiver can cause errors and a wide transmit bandwidth that may interfere with other stations.

■ **DATA Connector Pin Functions**

This section describes each pin of the DATA connector equipped on this transceiver.

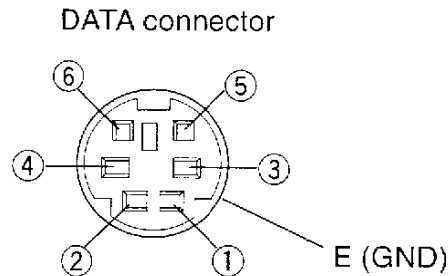

Pin No.	Pin Name	Function
1	PKD	Packet data input <ul style="list-style-type: none">• TX data from TNC to transceiver
2	DE	Ground for PKD
3	PKS	Packet standby <ul style="list-style-type: none">• TNC can use this pin to inhibit the transceiver microphone input while transmitting packet signals.
4	PR9	Output of detected 9600 bps data (500 mV _{P-P} , 10 kΩ) <ul style="list-style-type: none">• Also functions as a common pin for 1200 bps and 9600 bps data output.
5	PR1	Output of detected 1200 bps data (500 mV _{P-P} , 10 kΩ)
6	SQC	Squelch control output <ul style="list-style-type: none">• Inhibits TNC data transmitting while transceiver squelch is open.• Prevents interference to voice communications on the same frequency. Also prevents retries.• Output Level<ul style="list-style-type: none">Open squelch: +5 V (High)Closed squelch: 0 V (Low)

Note:

- ◆ If your TNC has a common pin for 1200 bps and 9600 bps data input, connect this pin to the DATA connector PR9 pin. Shorting the PR9 and PR1 pins will cause the TNC to malfunction.
- ◆ When DC voltage is input to the PR1 pin, the TNC may not function. If this problem happens, add a 10 μF capacitor between the PR1 pin and the TNC. Be careful with the polarity of the capacitor.

VS-3 VOICE SYNTHESIZER (OPTIONAL)

Install the optional VS-3 unit to use this function {page 67}. Each time you change the transceiver mode, such as VFO or Memory Recall, the transceiver automatically announces the new mode.

The table below shows what the transceiver automatically announces when it enters a new mode.

Key Pressed	New Mode	Announcement
[VFO]	VFO	"VFO"
[MR]	Memory Recall	"MR"
[CALL]	Call Channel	"Call"
[PM]	Programmable Memory	"PM"
[MNU]	Menu	"Menu"
[BAND]	New operating band	Current frequency
Mic PF key programmed with Enter {page 51} ¹	Keypad Direct Entry	"Enter"

¹ When pressed in VFO or Memory Recall mode.

In addition, the transceiver announces the displayed information as follows when pressing Mic [6] in Microphone Control mode {page 60} or the PF key programmed with Voice {page 51}.

- In VFO mode, announces the VFO frequency on the current band beginning with the 100 MHz digit. For the MHz decimal point, announces "point".
- In Memory Recall mode, announces the channel number, "channel", and the frequency. For the L or U channels, announces "low" or "up", the channel number, and the frequency. For the Priority channel, announces "PR" and the frequency.
- In Channel Display mode, announces the channel number and "channel". For the L or U channels, announces "low" or "up" and the channel number. For the Priority channel, announces only "PR".
- In Call Channel mode, announces "call" and the frequency.
- While a tone frequency is being selected, announces the tone frequency.

After installing the optional VS-3 unit, you can also reprogram the DIM button on the front panel with Voice. Access Menu No. 18 (KEY), and select Voice (VOIC).

17

Note:

- ◆ To deactivate the Voice Synthesizer function after installing the optional VS-3 unit, access Menu No. 17, and select OFF.
- ◆ While using Transceiver Lock, the transceiver makes an announcement only when pressing Mic [6] in Microphone Control mode or the PF key programmed with Voice. When in All Lock mode, pressing these keys simply causes an error beep to sound; the transceiver does not make an announcement in any case.
- ◆ The Voice Synthesizer function does not work while transmitting or scanning.

CROSS-BAND OPERATION

This transceiver is capable of receiving signals on one band and transmitting signals on another band. This function, however, is neither Cross-band Repeater nor Full Duplex. Cross-band Operation does not repeat signals originating from one band, using another band, and it does not receive and transmit signals simultaneously. This function is useful, for example, when joining in a group talk via a Cross-band Repeater. Participants in a group talk need to set a receive and transmit frequency on different bands so as not to miss any conversations within the group.

Note: It is illegal to use Cross-band Repeater in some countries. Check with your local regulations.

- 1 Press **[BAND]** to select the band for transmitting.
- 2 Select the appropriate transmit frequency.
- 3 Press **[BAND]** to select another band.
 - This band will be used for receiving.
- 4 Select the appropriate receive frequency.
- 5 Press **[F]**, **[⇄]** to enter Cross-band Operation mode.
 - A cross icon appears.

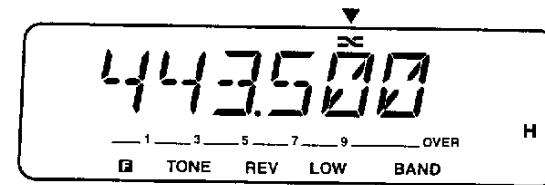

- 6 To exit Cross-band Operation mode, press **[F]**, **[⇄]** again.

Note:

- ◆ You can use only 144 MHz and 430/ 440 MHz bands to perform Cross-band operation.
- ◆ When in Cross-band Operation mode, pressing **[BAND]** switches the receive and transmit band.

18

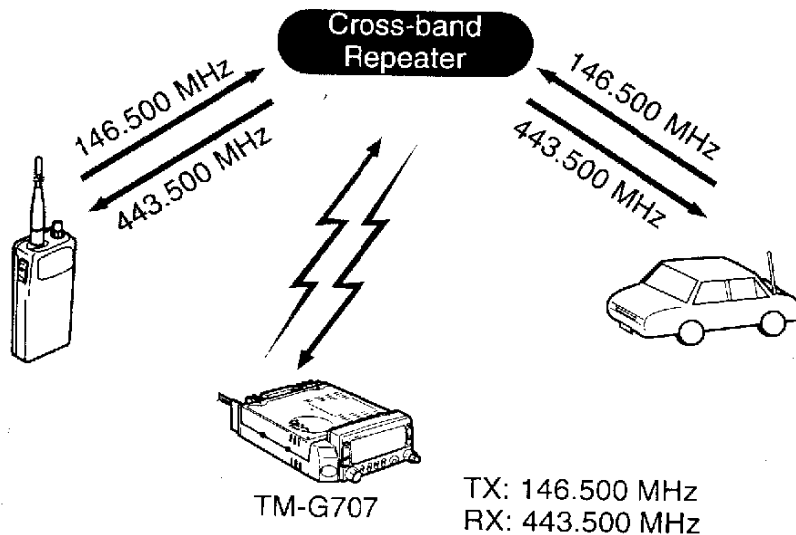

CLONE

Clone is used to copy exactly all transceiver settings to another TM-G707 transceiver. Everything set or stored in one transceiver is copied into another transceiver at one time. The cable for connecting the two TM-G707 transceivers is available as an option (E30-3326-05); contact a **KENWOOD** service center.

Note:

- ◆ Before connecting the cable, switch off the power to the two transceivers.
- ◆ The two TM-G707 transceivers must be the same market versions to use the Clone function.
- ◆ If “ERROR” appears on the display, you might have performed incorrect operations. Switch off the power to the two transceivers and exactly follow the procedures given in this manual.

- 1 Connect one end of the appropriate cable to the DATA connector of one transceiver.
- 2 Connect the other end of the cable to the DATA connector of another transceiver.
- 3 Configure one transceiver as required.
 - This transceiver is referred to as the “source transceiver” hereafter.
- 4 On the source transceiver, press **[F]+[REV]+ POWER ON**.
 - “CLONE” appears.



- 5 On the target transceiver, press **[F]+[REV]+ POWER ON**.
 - “CLONE” appears.
- 6 On the source transceiver, press **[CALL]**.
 - Data transfer starts.
 - “SEND” appears.

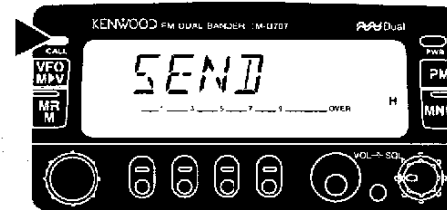

- When data transfer finishes, “END” appears on the source transceiver.
 - If data transfer fails, “ERROR” appears on the source transceiver.
- 7 Switch off the power to the two transceivers.
 - 8 Disconnect the cable from the two transceivers.

The connection cable equipped with 6-pin mini DIN plugs is wired as below:

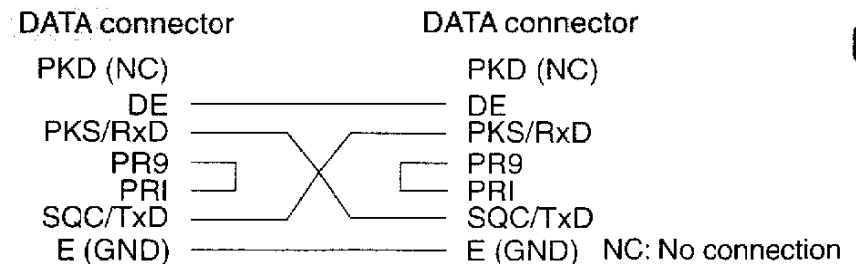

OPTIONAL ACCESSORIES

MC-45
Multi-function
Microphone

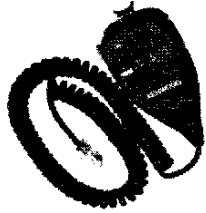

MC-53DM
Multi-function
Microphone with DTMF



MC-80
Desktop Microphone
(MJ-88 required)

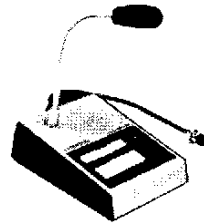

PS-33
Regulated DC Power
Supply

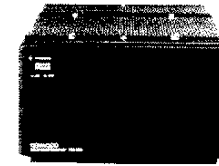

DFK-3C
Detachable Front
Panel Kit (3 m)



DFK-4C
Detachable Front
Panel Kit (4 m)



DFK-7C
Detachable Front
Panel Kit (7 m)



PG-2N
DC Power Cable



PG-3G
DC Line Noise Filter



PG-3B
DC Line Noise Filter

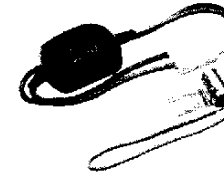

VS-3
Voice Synthesizer Unit

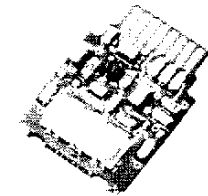

SP-41
Mobile Speaker



SP-50B
Communications
Speaker



PG-5A
Data Cable



MJ-88
Microphone Plug
Adapter



MJ-89
Modular Plug
Microphone Switch



INSTALLING OPTIONS

INSTALLING THE VS-3 VOICE SYNTHESIZER UNIT

CAUTION: ALWAYS SWITCH OFF THE POWER AND UNPLUG THE DC POWER CABLE FIRST.

- 1 Remove the five screws from the upper cover of the transceiver.

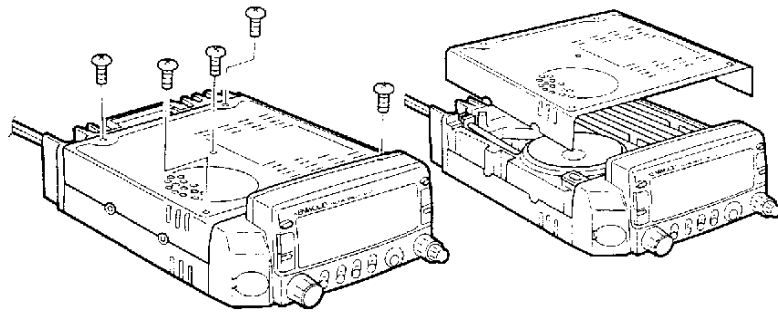

- 2 Hold the VS-3 unit with the component side facing inward, and insert the VS-3 connector into the corresponding transceiver connector.

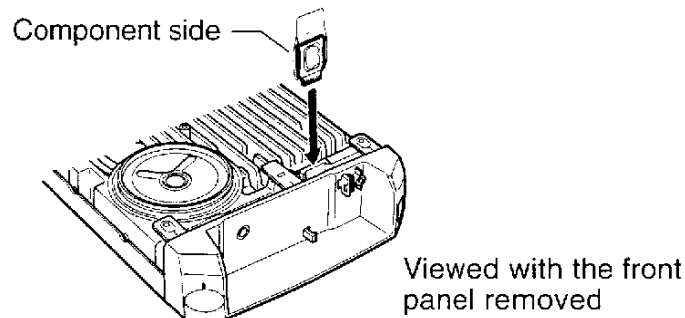

- 3 Replace the upper cover (5 screws).

INSTALLING A DETACHABLE FRONT PANEL KIT (DFK-3C/ DFK-4C/ DFK-7C)

CAUTION: ALWAYS SWITCH OFF THE POWER AND UNPLUG THE DC POWER CABLE FIRST.

- 1 While sliding the spring-loaded release switch on the rear of the front panel, remove the front panel from the main unit.

- Be careful not to drop the front panel when releasing it.

Release switch

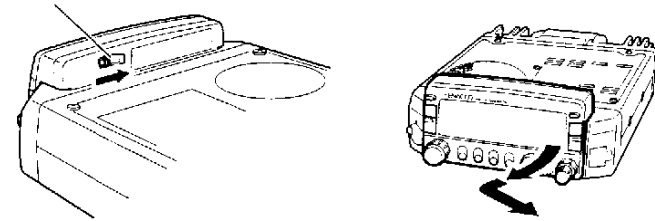

- 2 Hang the connector of the connectorized front panel cable onto the catch on the main unit, and secure the connector using the supplied screw.

- If the screw is loose, the transceiver may not function properly.

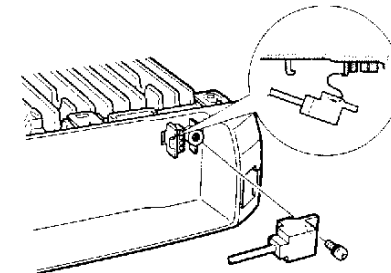

- 3 Connect the other end of the connectorized front panel cable to the One Touch panel.
- The cut-away corners of the connector should be inserted first into the space such that the corners mate with the positioning tab.

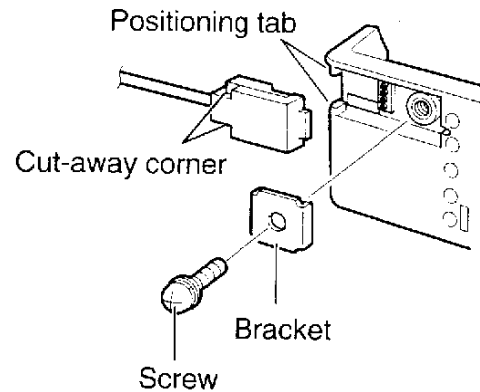

- 4 Install the front panel onto the One Touch panel by first positioning the left rear edge of the front panel, then pressing the right side of the front panel firmly against the One Touch panel.
- When the release switch clicks, the front panel is secured.

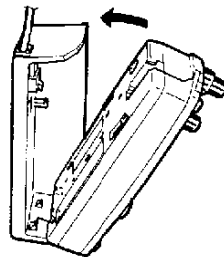

- 5 Assemble the mounting brackets, and install the front panel on the appropriate place in the vehicle.
- When installing the front panel in the vehicle, use a cushion under the bracket to protect the vehicle.
 - Adjust the angle of the front panel before firmly tightening the two Allen screws.
 - Route the cable so neither the connections nor the cable are under stress.

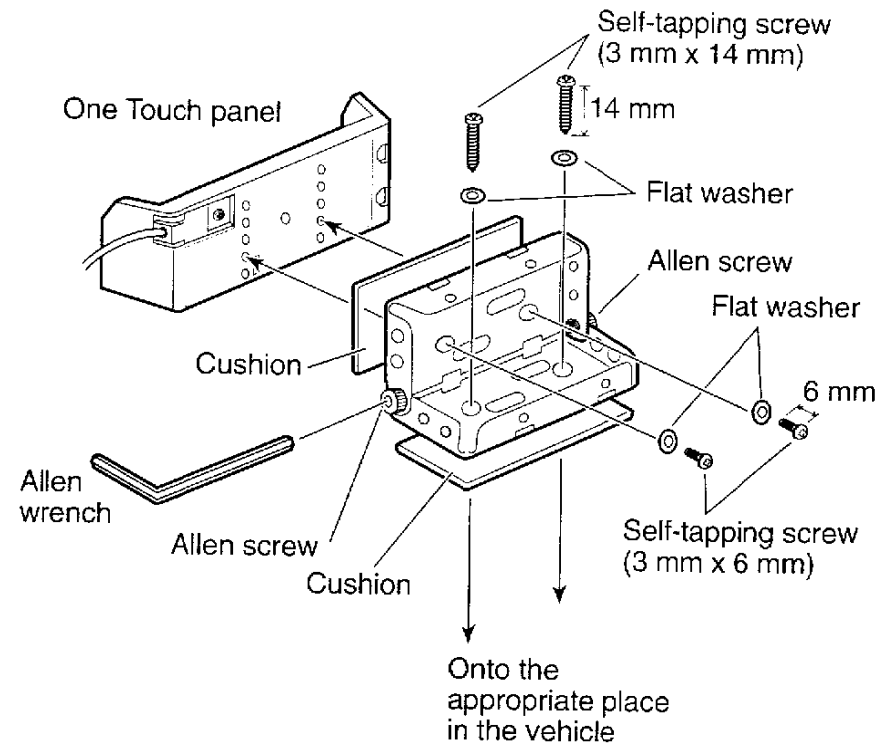

Note: Consider the safety of driver and passengers when deciding where to install the front panel. Tighten all screws firmly.

■ Installation Examples

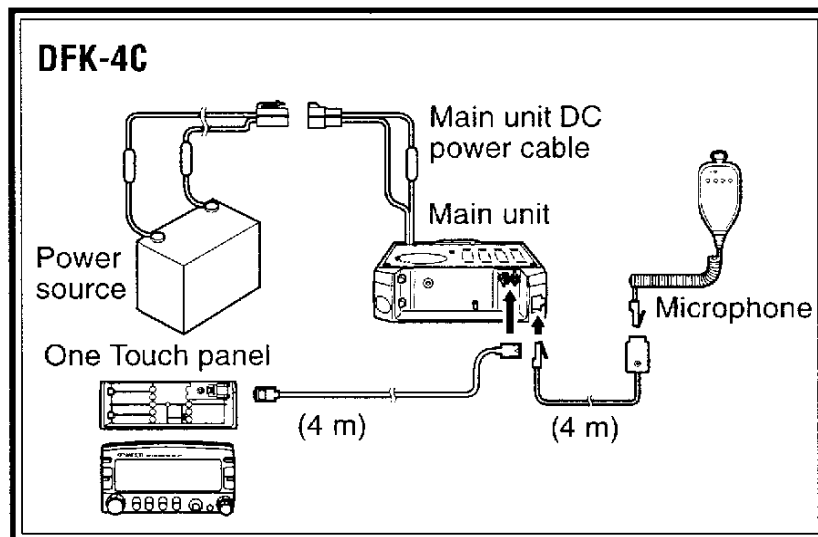
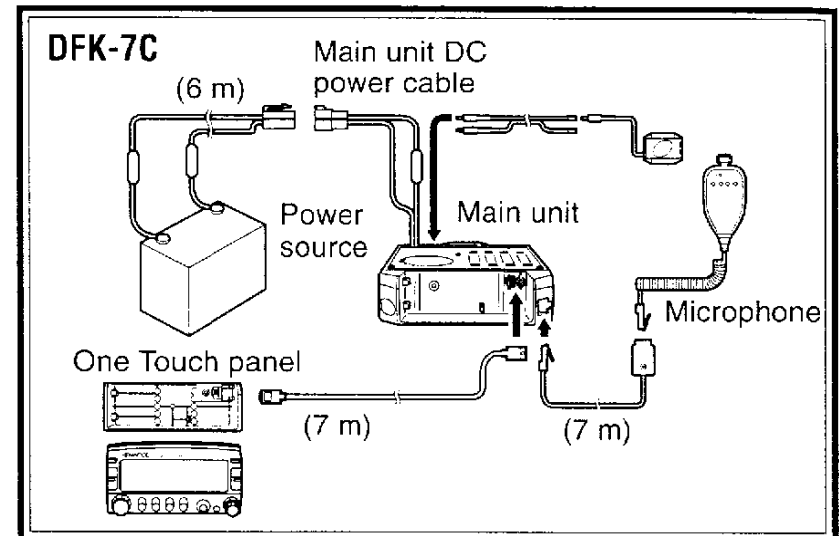
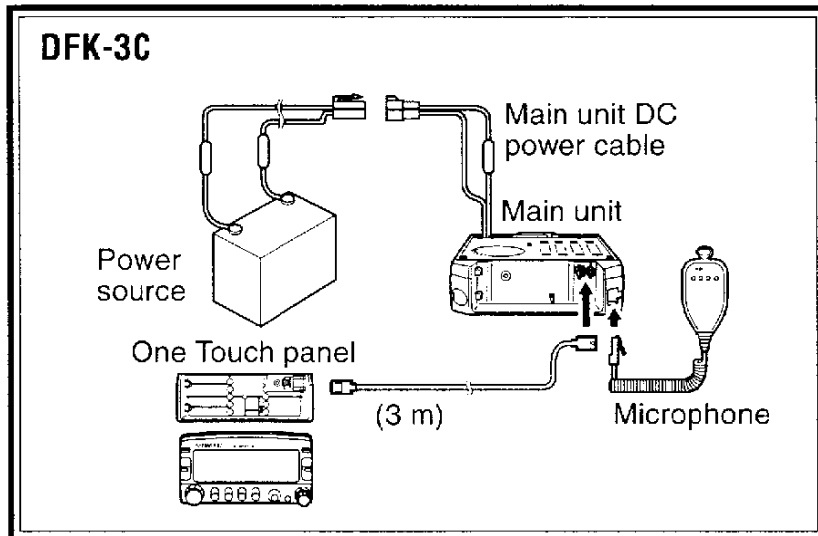

To install the microphone cable included with DFK-4C or DFK-7C, secure the microphone socket at the appropriate position in your vehicle using the long self-tapping screw (3 mm x 25 mm).

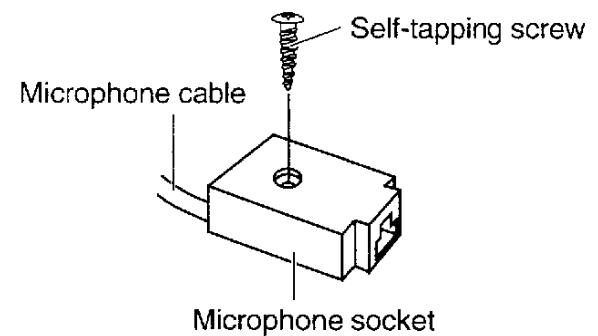

MAINTENANCE

GENERAL INFORMATION

Your transceiver has been factory aligned and tested to specification before shipment. All adjustable trimmers, coils and resistors in the transceiver were preset at the factory. They should only be readjusted by a qualified technician who is familiar with this transceiver and has the necessary test equipment. Attempting service or alignment without factory authorization can void the transceiver warranty.

SERVICE

When returning the equipment to your dealer or service center for repair, pack the transceiver in its original box and packing material. Include a full description of the problems experienced. Include both your telephone number and fax number (if available) along with your name and address in case the service technician needs to call you. Don't return accessory items unless you feel they are directly related to the service problem.

You may return your transceiver for service to the authorized **KENWOOD** dealer from whom you purchased it or any authorized **KENWOOD** service center. A copy of the service report will be returned with the transceiver. Please do not send subassemblies or printed circuit boards. Send the complete transceiver.

Tag all returned items with your name and call sign for identification. Please mention the model and serial number of the transceiver in any communication regarding the problem.

SERVICE NOTE

If you desire to correspond on a technical or operational problem, please make your note short, complete, and to the point. Help us help you by providing the following:

- 1 Model and serial number of equipment
- 2 Question or problem you are having
- 3 Other equipment in your station pertaining to the problem
- 4 Meter readings
- 5 Other information (Menu setup, mode, frequency, button sequence to induce malfunction, etc.)

CAUTION: DO NOT PACK THE EQUIPMENT IN CRUSHED NEWSPAPERS FOR SHIPMENT! EXTENSIVE DAMAGE MAY RESULT DURING ROUGH HANDLING OR SHIPPING.

Note:

- ◆ Record the date of purchase, serial number and dealer from whom the transceiver was purchased.
- ◆ For your own information, retain a written record of any maintenance performed on the transceiver.
- ◆ When claiming warranty service, please include a photocopy of the bill of sale, or other proof-of-purchase showing the date of sale.

CLEANING

Remove the controls from the transceiver when they become soiled and clean them with a neutral detergent and warm water. Use a neutral detergent (no strong chemicals) and a damp cloth to clean the case.

TROUBLESHOOTING

The problems described in this table are commonly encountered operational malfunctions. These types of difficulties are usually caused by improper hook-up, accidental incorrect control settings, or operator error due to incomplete programming. These problems are usually not caused by circuit failure. Please review this table, and the appropriate section(s) of this instruction manual, before assuming your transceiver is defective.

Problem	Probable Cause	Corrective Action	Page Ref.
<p>The transceiver will not power up after connecting a 13.8 V DC power supply and pressing the PWR switch. Nothing appears on the display.</p>	<p>1 The power cable was connected backwards.</p>	<p>1 Connect the supplied DC power cable correctly: Red → (+); Black → (-).</p>	<p>3, 4</p>
	<p>2 One or more of the power cable fuses are open.</p>	<p>2 Look for the cause of the blown fuse(s). After inspecting and correcting any problems, install a new fuse(s) with the same ratings.</p>	<p>5</p>
	<p>3 The front panel was not connected securely to the main unit of the transceiver.</p>	<p>3 Separate the front panel from the main unit by using the release switch on the rear of the front panel, then lock the front panel securely to the main unit by using the same switch.</p>	<p>67</p>
	<p>4 The connectorized cable was not correctly connected.</p>	<p>4 Connect the connectorized cable correctly.</p>	<p>3, 4</p>
<p>The way the transceiver functions or displays information is strange.</p>	<p>The electrical contacts on the front panel and main unit were soiled.</p>	<p>Clean the electrical contacts on both the front panel and the main unit using a clean damp cloth.</p>	<p>—</p>

Continued

Problem	Probable Cause	Corrective Action	Page Ref.
The display is too dim, even though you selected a high dimmer level.	The supply voltage is too low.	The supply voltage requirement is 13.8 V DC \pm 15% (11.7 V to 15.8 V DC). If the input voltage is outside this range, recharge your battery, adjust your regulated power supply, and/or check all power cable connections.	3, 4
The frequency cannot be selected by turning the Tuning control or by pressing Mic [UP]/ [DWN] .	Memory Recall was selected.	Press [VFO] .	8
Most buttons/keys and the Tuning control do not function.	<ol style="list-style-type: none"> 1 One of the Lock functions is ON. 2 The front panel was not connected securely to the main unit of the transceiver. 	<ol style="list-style-type: none"> 1 Unlock all of the Lock functions. 2 Separate the front panel from the main unit by using the release switch on the rear of the front panel, then lock the front panel securely to the main unit by using the same switch. 	57 67
Memory channels cannot be selected by turning the Tuning control or by pressing Mic [UP]/ [DWN] when using Memory Recall.	No data has been stored in any memory channels, or stored data was erased by Full Reset.	Store data in some memory channels.	28

Continued

Problem	Probable Cause	Corrective Action	Page Ref.
You cannot transmit even though you press Mic [PTT].	<ol style="list-style-type: none"> 1 The microphone plug was not inserted completely into the front panel connector. 2 You selected a transmit offset that places the transmit frequency outside the allowable transmit frequency range. 	<ol style="list-style-type: none"> 1 Switch OFF the power, then insert the microphone plug until the locking tab clicks in place. 2 Press [F], [SHIFT] repeatedly so neither "+" nor "-" is visible. 	6 23
Packet operation results in no connects with other stations.	<ol style="list-style-type: none"> 1 Your frequency differs from the target station's frequency. 2 The modulation level from the TNC is incorrect. 3 There is multi-path distortion. 4 The TX delay of your TNC may not be long enough. 	<ol style="list-style-type: none"> 1 Adjust your frequency using the Tuning control. 2 Adjust the TNC modulation level according to the TNC instruction manual. 3 Reorient or relocate the antenna. The strongest signal does not always provide the best operation on packet. 4 It is recommended to set the TX delay parameter on the TNC to 300 ms by using your computer. 	16 61 — 61

Note: You can also use the RESET switch to initialize settings. Push the switch momentarily to do Partial Reset or press it for 1 second or longer to do Full Reset (page 33). No confirmation message appears. Use this switch when the microcomputer and/or the memory chip malfunction because of ambient factors.

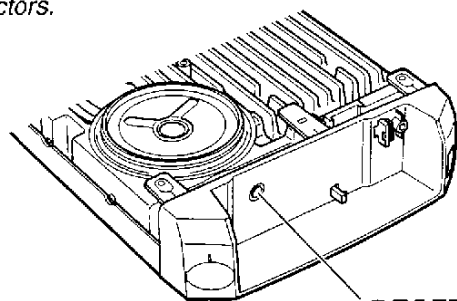

Viewed with the front panel removed

RESET switch

SPECIFICATIONS

Specifications are subject to change without notice due to advancements in technology.

General		VHF Band	UHF Band
Frequency range	U.S.A./ Canada	144 ~ 148 MHz	438 ~ 450 MHz
	General	144 ~ 148 MHz ¹	430 ~ 440 MHz
	Europe	144 ~ 146 MHz	430 ~ 440 MHz
Mode		F3E (FM)	
Antenna impedance		50 Ω	
Usable temperature range		-20°C ~ +60°C (-4°F ~ +140°F)	
Power supply		13.8 V DC ±15% (11.7 ~ 15.8 V)	
Grounding method		Negative ground	
Current	Transmit (max.)	11.0 A or less	10.0 A or less
	Receive (at 2 W output)	1.0 A or less	
Frequency stability (-10°C ~ +50°C)		Within ±3 ppm	
Dimensions (W x H x D projections not included)		140 x 40 x 189 mm / 5.51" x 1.57" x 7.44"	
Weight		1.2 kg / 2.6 lb	

¹ Taiwan: 144 ~ 146 MHz

Transmitter		VHF Band	UHF Band
Power output	High	50 W ¹	35 W ¹
	Medium	Approx. 10 W	
	Low	Approx. 5 W	
Modulation		Reactance	
Spurious emissions		-60 dB or less	
Maximum frequency deviation		±5 kHz	
Audio distortion (at 60% modulation)		3% or less	
Microphone impedance		600 Ω	

¹ Taiwan: 25 W (both bands)

Receiver	VHF Band	UHF Band
Circuitry	Double conversion superheterodyne	
Intermediate frequency (1st/ 2nd)	38.85 MHz/ 450 kHz	
Sensitivity (12 dB SINAD)	0.16 μV or less	
Selectivity (-6 dB)	12 kHz or more	
Selectivity (-60 dB)	28 kHz or less	
Squelch sensitivity	0.1 μV or less	
Audio output (8 ohms, 5% distortion)	2 W or higher	
Audio output impedance	8 Ω	

POWER ON FUNCTIONS SUMMARY

This table concludes the functions that you can initiate using the **PWR** switch. After switching OFF the transceiver, press and hold the appropriate key, then press the **PWR** switch.

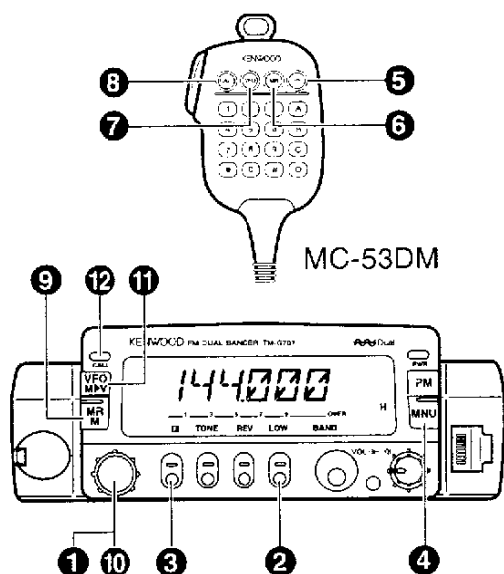

	Function	Key Combination	Ref. Page
①	All Lock ON/ OFF ¹	[MHz]	57
②	Channel Display ON/ OFF	[LOW]	32
③	Display Demonstration ON/ OFF	[F]	56
④	Easy Operation ON/ OFF	[MNU]	18
⑤	Program Function Keys ²	Mic [PF]	50
⑥		Mic [MR]	
⑦		Mic [VFO]	
⑧		Mic [CALL]	
⑨	Full Reset (Memory)	[MR]	33
⑩	Memory Channel Clear ³	[MHz]	29
⑪	Partial Reset (VFO)	[VFO]	33
⑫	Programmable Memory Reset	[CALL]	37

¹ First press [F], [MHz] to switch Transceiver Lock ON.

² Next press the key or key combination on the front panel that you want to assign.

³ First recall the memory channel that you want to clear.

INDEX

Advanced Intercept Point (AIP)	59	Installation	Transfer to VFO	32	Scan
Automatic Power Off (APO)	52	Antenna	Menu		Call/Memory
Autopatch	48	DC Power Cable, Fixed Station	Access	19	Call/VFO
Channel Display Function	32	DC Power Cable, Mobile	Configuration	20	Carrier-Operated Resume
Clone	65	DFK 3C/ 4C/ 7C	Microphone Connection	6	Memory
Continuous Tone Coded Squelch System (CTCSS) ...	46	External Speaker	Control	60	MHz
Cross-band Operation	64	Microphone	Offset		Priority
Display		Packet Equipment	Automatic Repeater	25	Program
Demonstration mode	56	VS-3	Direction	23	Time-Operated Resume ...
Dimmer, Changing	56	Keypad Direct Entry	Frequency	23	VFO
Dual Tone Multi-Frequency (DTMF) Functions		Frequency	Packet Operation	61	Squelch
Confirming Stored Numbers	49	Memory Channel Number	Power-ON Message	57	Adjusting
Making Calls	48	Tone Frequency Number	Programmable Function (PF) keys	50	S-meter
Storing Numbers	49	Lock	Programmable Memory (PM)		Switching AM/FM
Transmitting Stored Numbers	49	All Lock	Auto Storing	37	Time-Out Timer (TOT)
Easy Operation	18	Transceiver Lock	Recalling	36	Tone
Frequencies, Selecting		Memory Channels	Resetting	37	Activating
Microphone [UP]/ [DWN] ..	16	Call Channel, Changing	Storing	36	Automatic ID
Tuning Control	16	Call Channel, Recalling	Programmable VFO	53	Direct Number Entry
Frequency Step Size	55	Clearing	Repeater Access	22	Selecting
Fuses, Replacing	5	Direct Number Entry	Reset		Transmit Output Power
		Locking Out	Full (Memory)	33	Voice Synthesizer (VS-3)
		Naming	Partial (VFO)	33	Volume
		Recalling	Programmable Memory (PM)	37	Audio
		Storing, Odd-split	Reverse Function	26	Beep
		Storing, Simplex			

KENWOOD

**Downloaded by
RadioAmateur.EU**