

### INSTRUCTION MANUAL



Illustrated is the USA version.

Thank you for purchasing our latest product, the new TM-201B transceiver. Please read this instruction manual carefully before placing your transceiver in service. The unit has been carefully engineered and manufactured to rigid quality standards, and should give you satisfactory and dependable operation for many years.

### CONTENTS:

1. FEATURES.....	3
2. CONTROLS AND THEIR FUNCTIONS .....	4
3. INSTALLATIONS AND CONNECTIONS .....	9
4. OPERATION .....	13
5. MAINTENANCE AND ADJUSTMENT.....	18
6. ACCESSORIES.....	19
7. BLOCK DIAGRAM .....	22
8. SPECIFICATIONS.....	23

**Downloaded by  
RadioAmateur.EU**

## ■ ACCESSORIES

①

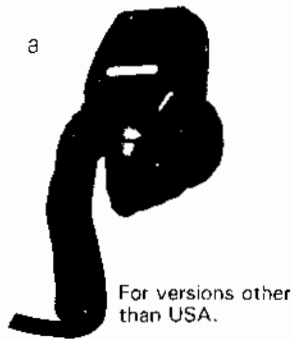

②

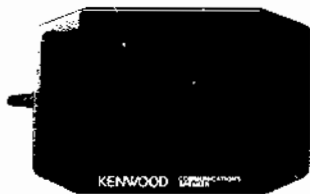

Carefully unpack your TM-201B and confirm that it is supplied with the following accessories:

- ① Microphone
  - a Dynamic microphone ..... (T91-0331-05) ... 1 pc.
  - b Electret condenser microphone with touch-tone... (T91-0332-15) ... 1 pc.
- ② Communications speaker (with 2.5 m lead) ..... (T19-0101-05) ... 1 pc.
- ③ Speaker mounting kit
  - a Bracket..... (J21-2799-13) ... 1 pc.
  - b Cushion (A) ..... (G13-0680-04) ... 1 pc.
  - c Tapping screw ( $\phi 4 \times 8$ ) ..... (N87-4008-41) ... 4 pcs.
  - d Flat head tapping screw ( $\phi 4 \times 8$ ) ..... (N88-4008-41) ... 2 pcs.
  - e Round head screw ( $\phi 4 \times 10$ ) ..... (N30-4010-41) ... 2 pcs.
  - f Hex. head nut ( $\phi 4$ ) ..... (N10-2040-41) ... 2 pcs.
- ④ Mobile mounting kit
  - g Mounting bracket..... (A13-0640-12) ... 1 pc.
  - h Boss (Two of 6 pcs. are spare parts.) ..... (J32-0775-14) ... 6 pcs.
  - i Flat washer for boss ( $\phi 3$ ) ..... (N19-0631-05) ... 4 pcs.
  - j Flat screw for boss ( $\phi 3 \times 14$ ) ..... (N32-3014-41) ... 4 pcs.
  - k Round head screw ( $\phi 6 \times 20$ ) ..... (N09-0008-04) ... 4 pcs.
  - l Flat washer ( $\phi 6$ ) ..... (N15-1060-46) ... 4 pcs.
  - m Spring washer ( $\phi 6$ ) ..... (N16-0060-46) ... 4 pcs.
  - n Flange nut ( $\phi 6$ ) ..... (N14-0510-04) ... 4 pcs.
  - o Tapping screw ( $\phi 5 \times 12$ ) ..... (N09-0632-05) ... 4 pcs.
  - p Flat washer ( $\phi 5$ ) ..... (N15-1050-46) ... 4 pcs.
  - q Cushion (B) ..... (G13-0683-04) ... 1 pc.
  - r Cushion (C) ..... (G13-0686-04) ... 2 pcs.
- ⑤ DC power cord (Approx. 2 m) ..... (E30-2022-15) ... 1 pc.
- ⑥ Spare fuse (10A) ..... (F05-1031-05) ... 1 pc.
- ⑦ Instruction manual ..... (B50-4059-10) ... 1 copy

③

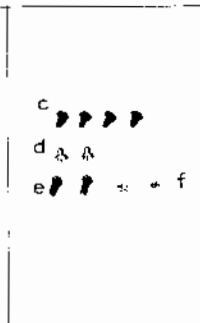
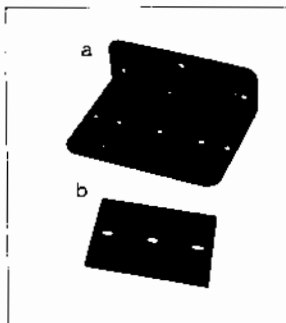

④

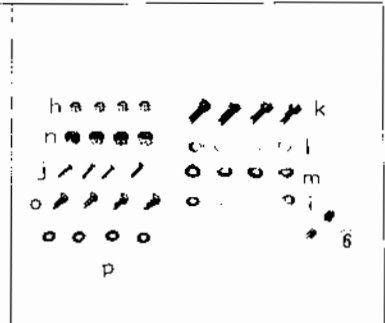
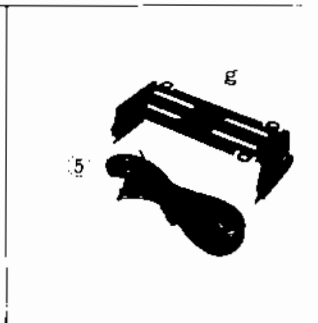

## ■ AFTER UNPACKING

### Shipping container:

Save the boxes and packing in the event your unit needs to be transported for remote operation, maintenance, or service.

### The following explicit definitions apply in this manual:

**Note:** If disregarded, inconvenience only, no risk of equipment damage or personal injury.

**Caution:** Equipment damage may occur, but not personal injury.

# 1. FEATURES

- **Compact, slim transceiver for easy mobility**

1. Coaxial connector with cable greatly reduces effective depth when connecting an antenna cable.
2. External speaker system allows installation in any place.
3. Remote frequency control unit (FC-10) extends your operation a flexibility.

- **Microcomputer provides multi-frequency control functions**

1. Five channel memories plus COM channel.
2. ALERT function monitors memory channel 1 (M1).
3. Memory scan operation (MS) from memory channels 1 through 5.
4. Programmable scan within the selected frequency range.
5. 1 MHz step-up function (MHz).
6. VFO A in 5 kHz (25 kHz; for European and British versions) steps; VFO B in 5 kHz steps.
7. Beeper indicates each of 7 modes.

- **Dual function keyboard facilitates memory recall (MR)**

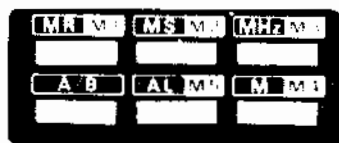

- **High reliability by using PC boards for each unit; high sensitivity (12 dB SINAD 0.22  $\mu$ V) front-end using GaAs FETs**

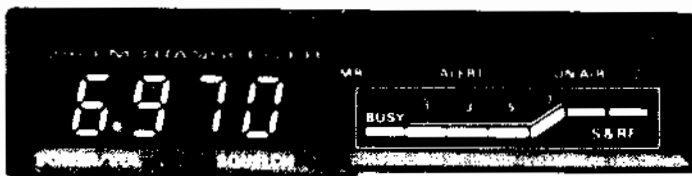

- **Quality sound for transmission and reception**

1. External communications speaker, 77 mm in dia., supplied.
2. Maximum 3% modulation distortion ensures good quality transmit signal.

- **HI/LOW switch controls output power**

- **Repeater operation**

1. COM system facilitates access to repeaters with the TU-3 or TU-3A tone unit\* (option) installed.
2. The TU-3 or TU-3A 2nd tone frequency (one of 37 frequencies selectable) interconnected with the TX OFFSET system enables access to a repeater.
3. The REV switch monitors direct signal.

- **Extended frequency range\***

Covers 142.0 ~ 148.995 MHz in 5 kHz steps.

(Specifications guaranteed for the 144 ~ 148 MHz Amateur band only)

## 2. CONTROLS AND THEIR FUNCTIONS

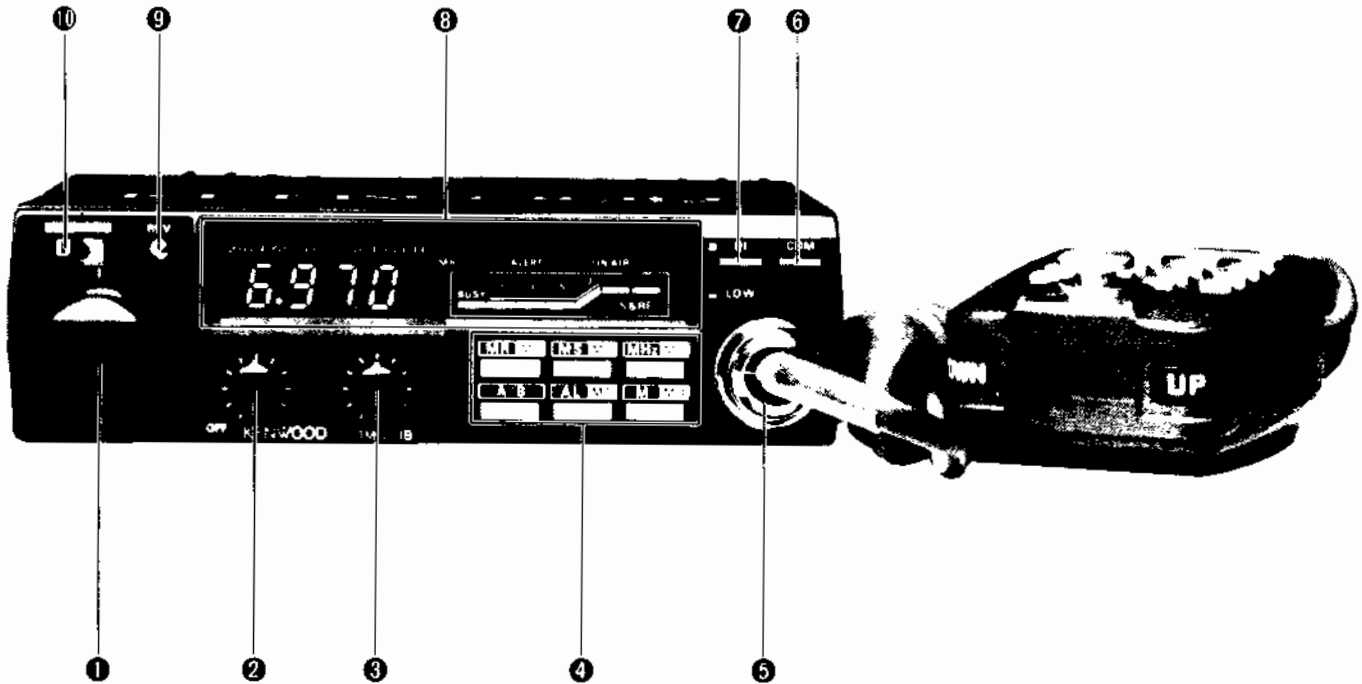

### ■ FRONT PANEL

#### ① Tuning control (VFO)

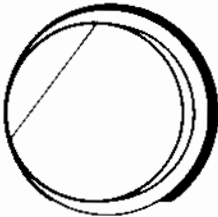

Used to select the transmit and receive frequency. During memory recall operation, turning this control restores the operation to VFO control.

**Note:** One click rotation shifts the displayed frequency one step up or down. However, occasionally the frequency step may change due to microprocessor transients.

#### ② VOL/POWER

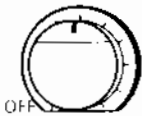

Power ON-OFF switch and volume control. Turning the control fully counter-clockwise will turn the power OFF. Clockwise rotation will increase the volume.

#### ③ SQUELCH

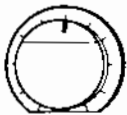

The squelch control is used to eliminate noise during no-signal periods. Normally, this control is adjusted clockwise until the noise just disappears (squelch threshold). For scan operation, this control must be set to the threshold point.

#### ④ Keyboard

##### a. MR/M1 (memory recall) key



Used to recall memory channel information.

When first depressed, memory channel 1 is recalled. The MR indicator lights to show memory recall has been selected.

**To recall one of the other memory (M2 ~ M5), depress the MR/M1 key then the corresponding key M2 ~ M5.**

##### b. MS/M2 (memory scan) key



Used to initiate memory channels scan.

During memory recall operation, depressing this key recalls memory CH2.

During memory scan, depressing this key recalls the next memory channels.

c **MHz/M3 (1 MHz up) key**

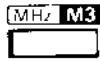

When depressed, the displayed frequency shifts up 1 MHz. During memory recall operation, depressing this key recalls memory CH3.

d **M/M4 (memory input) key**

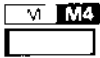

Used to store the desired frequency in memory.

For memory input, refer to page 15.

During memory recall operation, depressing this key recalls memory CH4.

In memory CH4, transmit and receive frequencies are stored independently for odd split operation.

e **AL/M5 (alert) key**



When depressed, the ALERT indicator lights to show alert operation is in progress.

Depressing this key again releases this operation. For more details, refer to page 17.

During memory recall operation, depressing this key recalls memory CH5.

Memory channel 5 is used for odd split operation as is memory channel 4.

The frequencies (transmit and receive) stored in CH5 designate frequency range limits for programmable scan operation.

For more details, refer to page 15.

f **A/B (VFO A/B selection, scan stop) key**

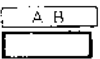

As shown in the table, this key provides three types of operation.

Mode	A/B key functions
VFO	Each time the key is depressed, VFO A and B are selected alternately.
MR	When depressed, the VFO frequency that was selected before memory recall, is restored.
SCAN	When depressed, scan is released.

5 **MIC connector (8 pin)**

Microphone audio input. Frequency UP/DWN control and PTT lines are included. Pin assignments of the MIC connector are shown below.

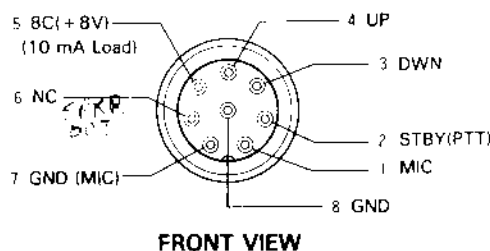

**Note:** Do not apply voltage to pins 2, 3, and 4. Pin 5 should not be shorted or have any voltage applied.

6 **COM (common channel) key**



When the key is depressed initially, the common channel can be recalled regardless for mode. This channel can be programmed to any desired frequency. For common channel programming, refer to page 15. To release common channel operation, depress this key again. No other key will release the operation.

When the optional TU-3 or TU-3A tone unit is installed, the 1st tone frequency is emitted when operating the COM channel.

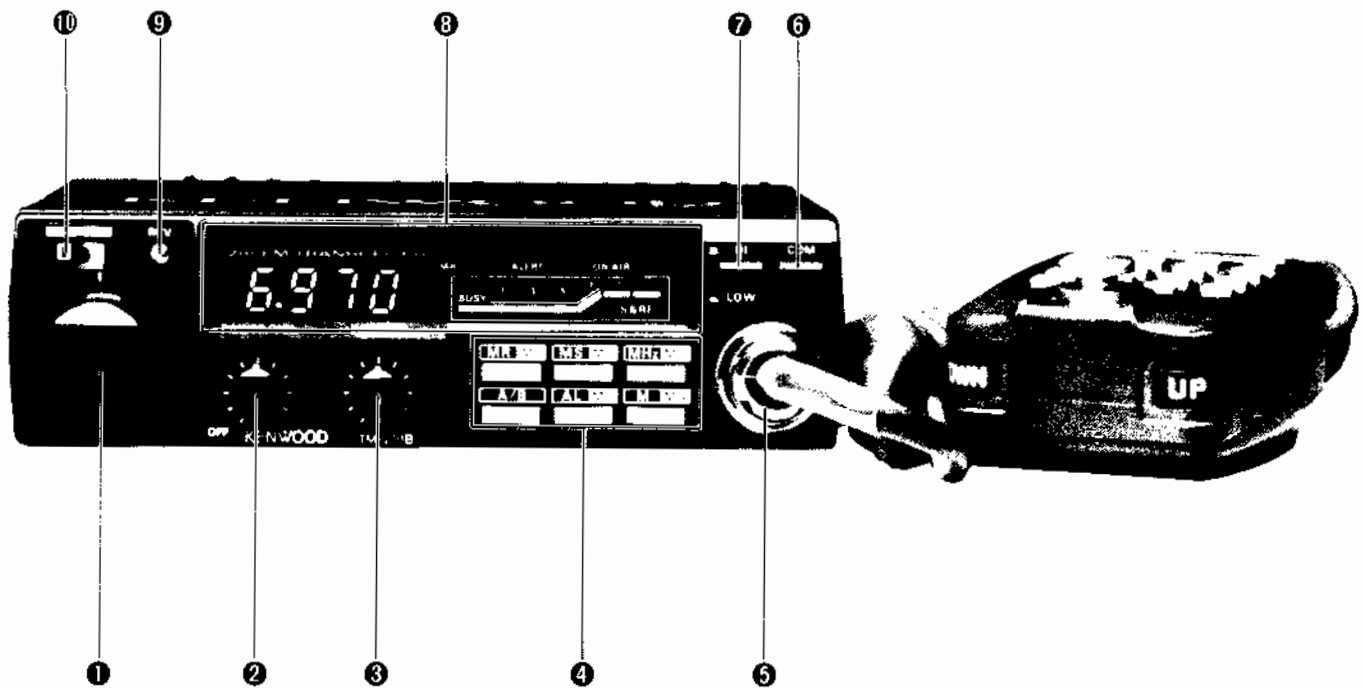

**7 HI/LOW switch**

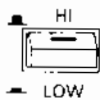

HI setting: This setting causes the transmitter to transmit at approx. 45 watts.  
 LOW setting: This setting causes the transmitter to transmit approx. 5 watts.

**8 Display**

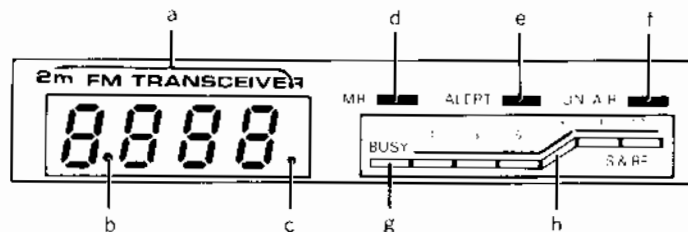

**a Frequency display**

During VFO A or B, frequency, for example, 145.02 is displayed in four digits as "5.020". 5.020

During MR (M1 — M5) operation, frequencies, such as, 145.24 are displayed in 4 digits as "5.240". 5.240

During COM\* operation, frequency is displayed in four digits. At this time, zero at the last digit is half size.

\* European and British versions excluded.

**b Scan indicator**

During scan operation, this dot flashes.

In operations other than scan, this dot lights to show MHz.

**c VFO B indicator**

Lights when VFO B is in operation.

**d MR indicator**

Lights during memory recall operation (M1 — M5, MS).

**e ALERT indicator**

Lights during alert operation.

**f ON AIR indicator**

Lights when transmitting.

**g BUSY indicator**

Lights during reception with squelch opened.

This can be used to see if the channel is busy or not.

**h S & RF meter**

Indicates the incoming signal strength by LEDs during reception.

During transmission, LEDs light to show the RF output level strength.

With the HI/LOW switch HI, all LEDs light.

With the HI/LOW switch LOW, two to four

9 REV switch



Used to reverse the repeater shift ( $\pm 600$  kHz) to monitor the repeater input. Setting this switch to ON in simplex operation locks the displayed frequency regardless of VFO, keyboard, and COM.CH operations.

10 TX OFFSET switch



Used to select the transmit frequency offset ( $\pm 600$  kHz) for repeater use. For other than of a repeater operation, place this switch to the "S" position. This equalizes the transmit and the receive frequency. "+" setting shifts +600 kHz; "-" setting shifts -600 kHz from the receive frequency when transmitting.

This operation is only effective in VFO and MR (M1 ~ M3) operations. If an offset frequency were to go beyond the operating frequency range when depressing the PTT switch to transmit, a beep will sound three times to indicate an error, and the radio will transmit simplex.

\*With the optional TU-3 or TU-3A tone unit installed, either "+" or "-" setting of the TX OFFSET switch connects the TU-3 or TU-3A 2nd tone frequency setting.

REAR PANEL

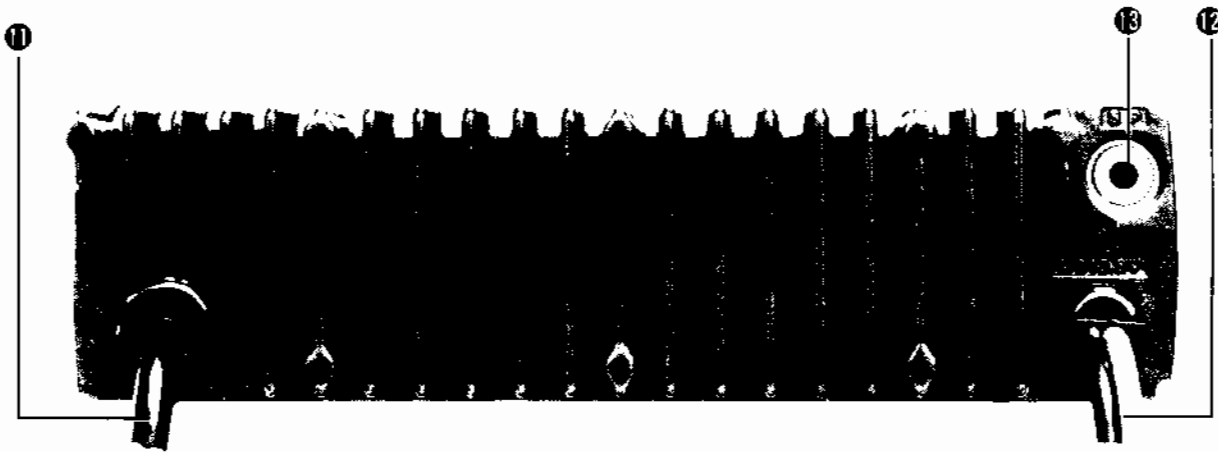

11 ANT connector lead

Connect a 50-ohm antenna to this terminal.

12 DC Power Lead

DC power input lead. Connect the supplied power cord with plug. Input voltage is 13.8 V DC.

Observe plus (+) and minus (-) polarity!

13 SP Terminal

Connect the supplied 8 ohm speaker to this jack.

RIGHT SIDE PANEL

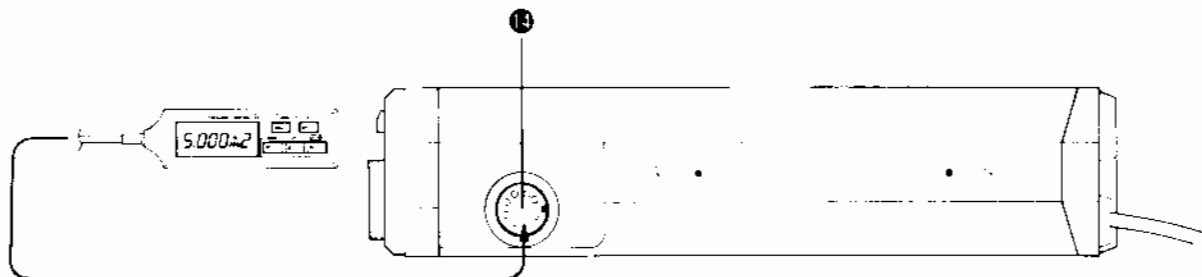

14 Remote jack

Used to connect the optional FC-10 unit, controlling the operation frequency.

## ■ MICROPHONE (For U.S.A. version)

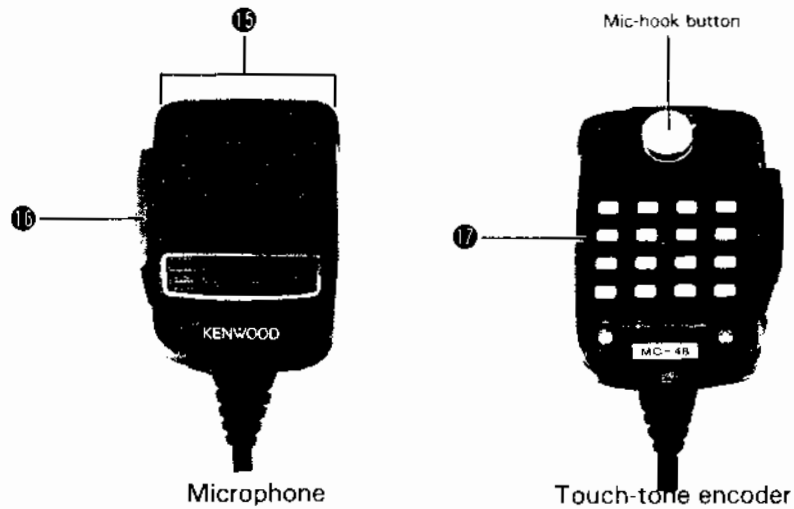

### 15 UP/DWN switches

- 1) Depressing the UP or DWN key momentarily, shifts the displayed frequency one step up or down.  
Holding the key depressed, continuously shifts the frequency up or down.
- 2) Holding the UP or DWN key depressed for about one second initiates scan operation. The scan direction depends on the UP or DWN key operated.
- 3) Depressing the UP or DWN key during MR operation will change the operation from MR to VFO.

### 16 PTT Switch

Press-to-talk switch is used for transmission. This will also releases scan operation. When releasing the SCAN operation, transmission is inhibited.

### 17 16 Touch-Tone Keys (Auto-patch operation)

Used to activate the touch-tone encoder.

## ■ MICROPHONE (For versions other than U.S.A.)

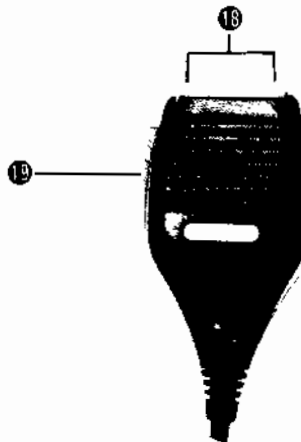

### 18 UP/DWN switches

- 1) Depressing the UP or DWN key momentarily shifts the displayed frequency one step up or down.  
Holding the key depressed continuously shifts the frequency up or down.
- 2) Holding the UP or DWN key depressed for about one second initiates scan operation. The scan direction depends on the UP or DWN key operated.
- 3) Depressing the UP or DWN key during MR operation will change the operation from MR to VFO.

### 19 PTT switch

Press-to-talk switch used for transmission. This will also release scan operation. When releasing the scan operation, transmission is inhibited.



# 3. INSTALLATIONS AND CONNECTIONS

## ■ ANTENNA

The performance of the transceiver depends to a great extent upon the type of antenna to be used. To ensure the maximum performance of the TM-201B, select a suitable antenna and adjust it for low VSWR.

## ■ MOBILE INSTALLATION

### • Interconnection

The TM-201B is equipped with an external speaker.

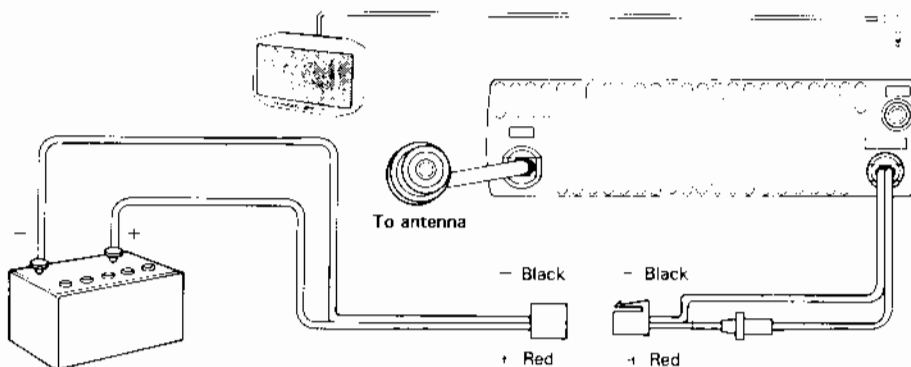

### • Installation location

Using the supplied mounting bracket, install the transceiver under the dashboard or on the side of the console in your car as shown. If your car is equipped with an electronic fuel injector, the transceiver should be mounted as far from the control equipment as possible.

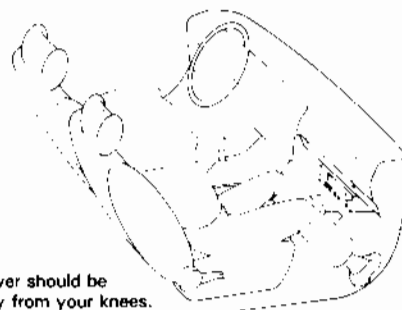
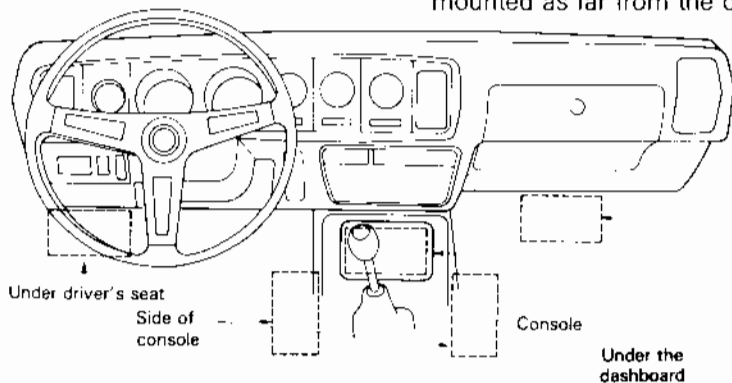

## ■ COMMUNICATIONS SPEAKER INSTALLATION

**Note:** For safety's sake, do not install the speaker on the ceiling.

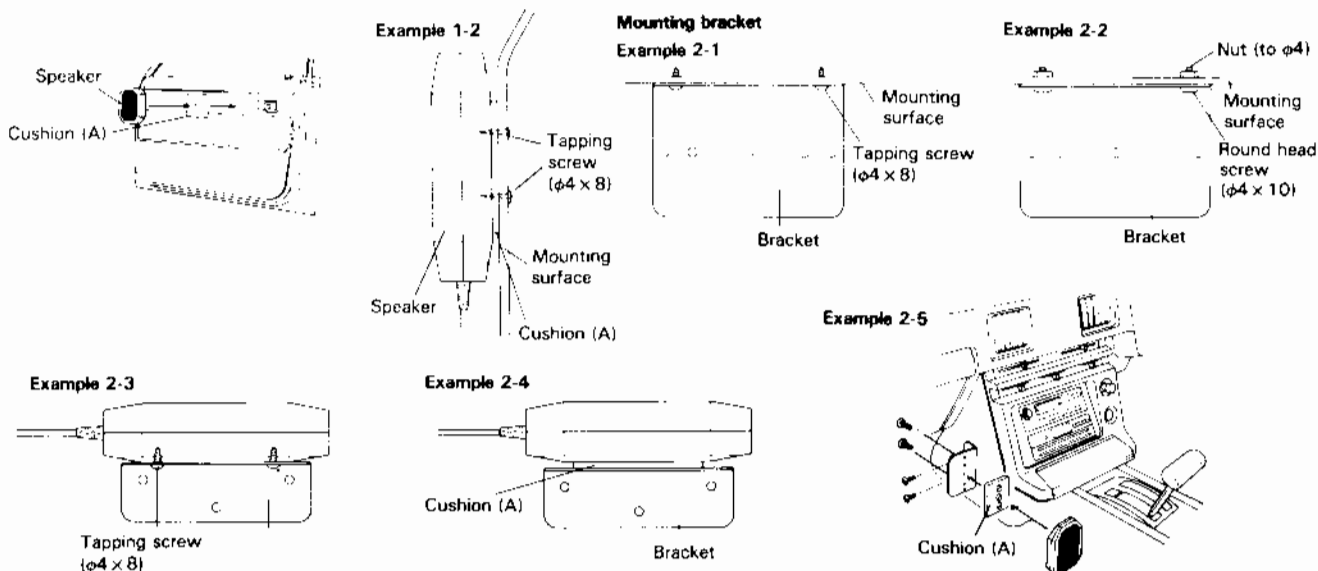

Example 2-6

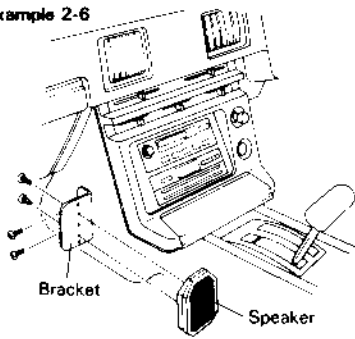

Example 2-7

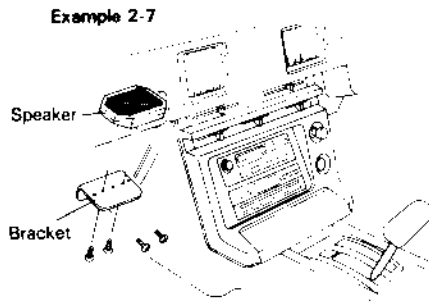

Example 2-8

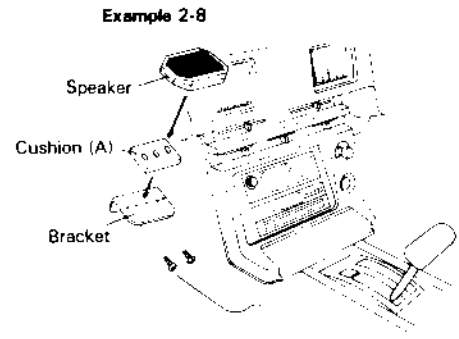

• Installation procedure

- 1) Secure the bosses on each side with 4 flat head screws. **(Fig. a)**
- 2) Affix the cushion (c) on each side of the mounting bracket. **(Fig. b)**
- 3) Secure the mounting bracket to the chassis as shown in **Fig. c**.  
When installing the bracket, be sure the front part of the bracket faces you.
- 4) Insert the transceiver as shown in **Fig. d** so the bosses on the transceiver slide into the grooves of the mounting bracket.
- 5) To stack with the TM-401B (70 cm), first secure the supplied stack plate to the TM-201B with bosses then stack the TM-401B, second insert the stacked transceivers as shown in Fig. d so the bosses on the upper transceiver slide into the grooves of the mounting bracket.

Fig. a Boss securing

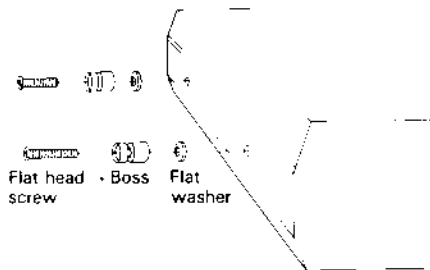

Be sure to use flat washers. However, when stack installation with the TM-401B is attempted, do not use these washers since the stack plates are used.

Fig. b Cushion attachment

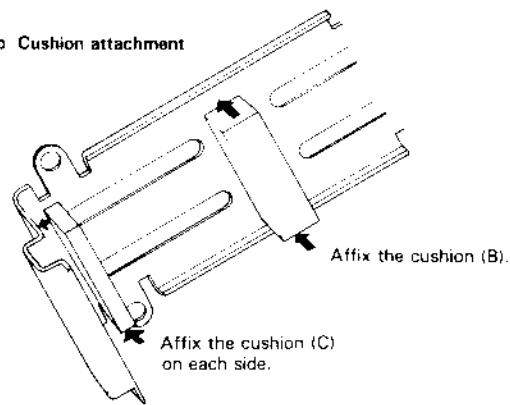
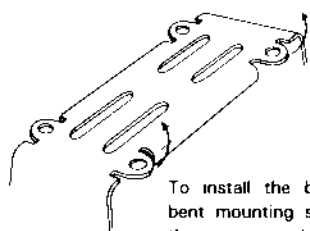
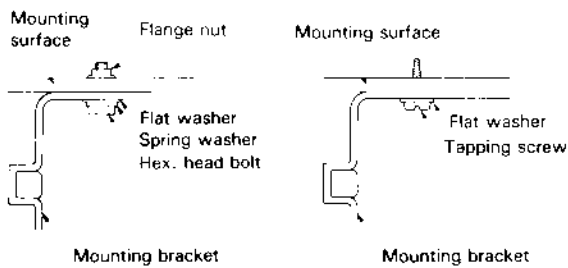

Fig. c Mounting bracket installation



To install the bracket on a bent mounting surface, bend these parts as shown.

Fig. d Transceiver installation

Transceiver installation  
Ensure the front/rear of the bracket when mounting.

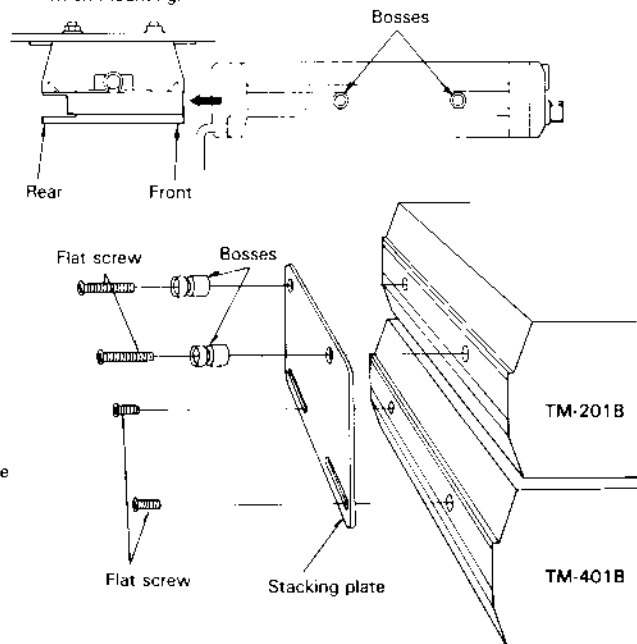

• **Antenna Installation**

Various types of antennas for VHF mobile operation are available.

**Note:**

For gutter-mount installation, the antenna bracket must be grounded to the car body as shown below. Affix the antenna securely, referring to the antenna provided with your instructions.

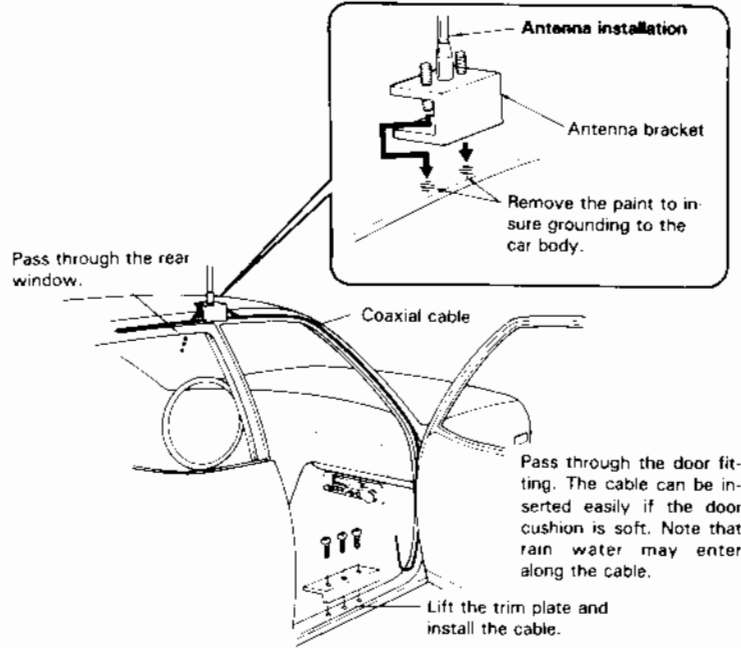
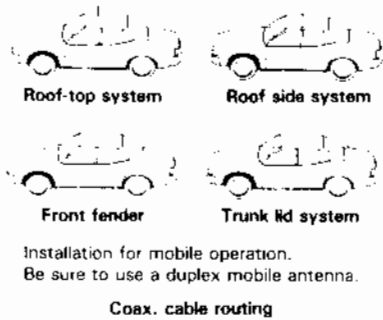

• **Power supply**

Connect the supplied power cable, with fuse, directly to the battery terminals. Connecting to the cigarette lighter socket can cause a poor connection, and excessive voltage drop.

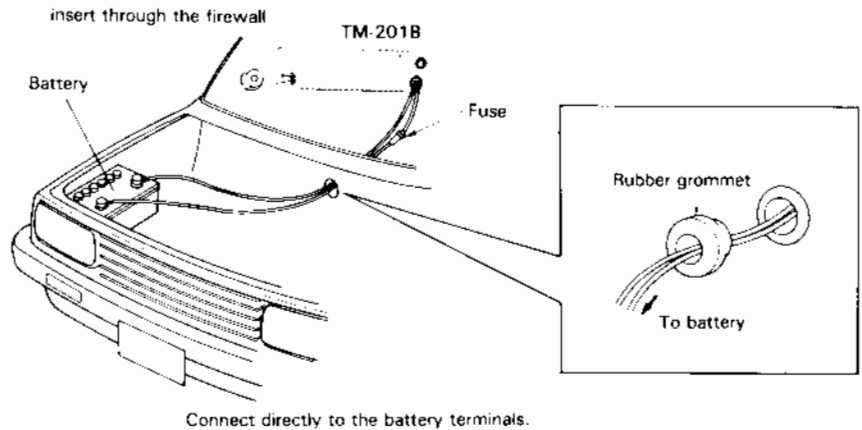

• **Ignition noise**

The transceiver is designed to suppress ignition noise; however, if excessive noise is present, it may be necessary to use suppressor spark plugs (with resistors).  
The PG-3A is available, should you required additional filtering.

**Downloaded by  
RadioAmateur.EU**

## ■ FIXED STATION INSTALLATION [general]

### • Power supply

A regulated DC power supply (13.8 V DC, 9.5 A or more) is required. It is recommended that the PS-430 be used for a power supply.

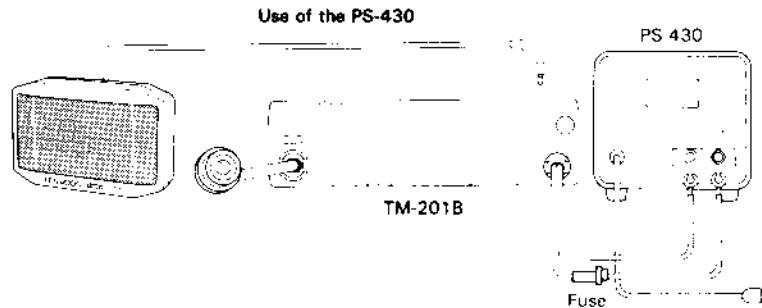

**NOTE:**

Preferably, voltage should be adjusted to 13.8 V DC. Current capacity is more than 9.5 A.

The regulated supply should be equipped with a built-in protection circuit for both overcurrent and over-voltage.

**CAUTION**

A battery charging power supply cannot be used.

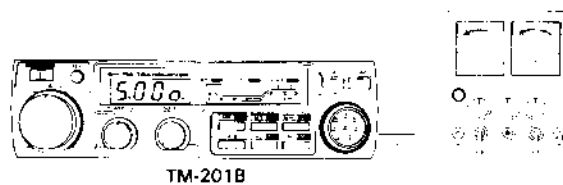

### • Antenna

Various types of fixed station antennas are commercially available, select your desired antenna according to your installation space and application.

Note that the SWR of your antenna should be less than 1.5. A high SWR will cause the TM-201B protective circuit to operate, reducing the transmit output power.

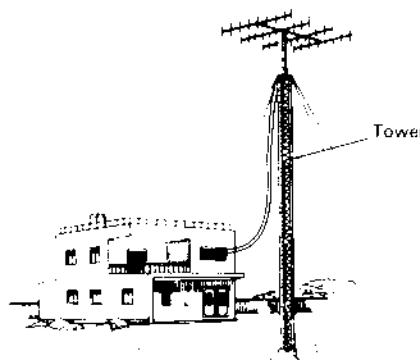
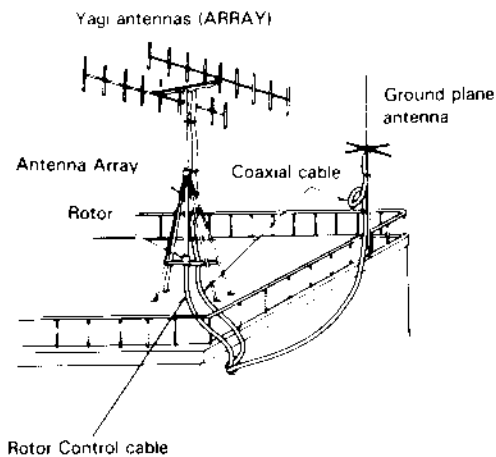

Transceiver performance depends largely on the type of antenna used. For fixed station operation there are ground plane antennas (omni-directional) and Yagi antennas (uni-directional). The Yagi antenna is suitable for long distance operation (DX) or communication with a specific party. (having excellent directivity and antenna is generally used for local operation.)

# 4. OPERATION

## ■ RECEPTION

When power and antenna connections are complete, set the controls and switches as follows:

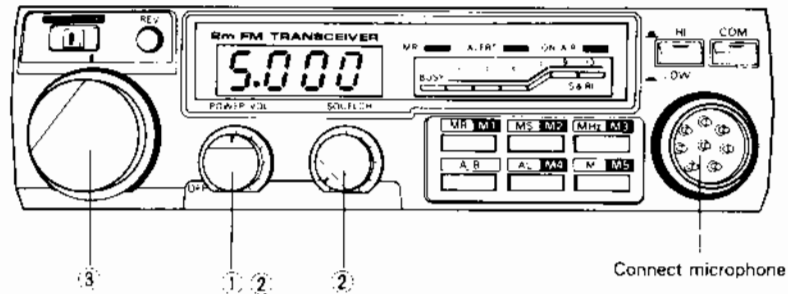

After verifying the initial setup of controls and switches, proceed as follows:

- (1) Turn the POWER/VOL control clockwise to turn on power. The indicators on the display light to show the transceiver is operating.
- (2) As the POWER/VOL control is turned clockwise, either noise or a QSO is heard.
- (3) To eliminate the no-signal noise, use the SQUELCH control. For SQUELCH control operation, refer to next explanation.
- (4) Tune to the desired frequency using the MAIN DIAL.

### • SQUELCH control



To eliminate receiver noise during no-signal periods, slowly adjust the squelch clockwise until the noise just disappears, and the BUSY indicator goes off (threshold point).

When a signal is received, the squelch will open, the BUSY indicator will light and the speaker will operate.

The SQUELCH control is also used for scan operation control. If the signal is weak or fades during mobile operation, readjust the squelch for constant reception.

## ■ TRANSMISSION

To transmit, first select the desired frequency to be used and see whether it is busy or not. If it is not busy, simply depress the mic PTT switch for transmission. The ON AIR indicator lights.

### • Transmitter precautions

- 1) The TM-201B antenna impedance is 50 ohms. Be sure to use only an antenna of 50 ohms impedance.
- 2) Check the intended transmit frequency before operating to prevent interference with other stations.
- 3) Pressing the microphone PTT switch places the transceiver in transmit mode; the ON AIR indicator will light and the LED bar meter shows transmitter power. Recommended talk distance to the microphone is approximately 5 cm.

### • HI/LOW power switch

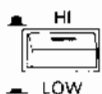

In local QSO's can be enjoyed with less interference to others and with less power consumption by reducing the RF output power. This is accomplished by depressing the HI/LOW switch, which reduces power from 45 W to approx. 5 W. The power indication will drop to approximately "2~4" on the meter.

## ■ 16 key AUTO PATCH OPERATION

To operate, hold the mic PTT switch depressed until after the first key has been depressed.

**Note:**

1. After PTT operation is initiated, the transceiver will remain in transmit mode even with the PTT switch released.
2. More than 0.8 seconds keying interval between digit entry will return the radio to receive mode.
3. The touch-tone encoder level can be readjusted according to your requirement.

When readjusting, set the deviation to 3 kHz by using the built-in VR (in the mic.) with both the 3 and 6 keys of the encoder held depressed. Next, hold both the 2 and 3 keys depressed to verify the deviation which is within  $1.2 \text{ kHz} \pm 0.3 \text{ kHz}$ .

## ■ VERIFICATION BEEP TONE

When operating, several beep sounds are provided to indicate operation. Beep level can be adjusted by the potentiometer inside. (page 18)

Beep	When beep will sound
Once	When a key is operated correctly.
Twice	When CH1 is busy during alert operation.
Three times	When ordering memory scan with all memory channels empty. When an offset frequency is out of operating frequency range.
Four times repeatedly	When transmit frequency for odd split is not stored, the beep will sound until the frequency is stored.
Five times	During REVerse operation
Eight times	When memory is ready to be stored.
Once for approx. 1.5 sec.	When memory is stored.

## ■ MEMORY INPUT IN (REPEATER COM CHANNEL AND\*) MEMORY CHANNEL

(1) In memory channels 1 – 3  
(Simplex channels)

	Procedure	Operation
1	Freq. setting	Set frequency to be stored using the tuning control or mic UP or DWN switch.
2	Memory standby	Depress the M/M4 key. The beep will sound eight times.
3	Memory input	Depress M1, M2 or M3 key while the beep is sounding. The 1.5 second beep sounds to verify the memory input.

(2) In memory channels 4, 5  
and COM\* (split channel)

	Procedure	Operation
1	Receive freq. setting	Set receive frequency to be stored using the tuning control or mic UP or DWN switch.
2	Memory standby	Depress the M/M4 key. The beep will sound eight times.
3	Memory input	Depress M4, M5 or COM* key while the beep sound is sounding. The 1.5 second beep sounds when the memory is input. Then the beep sounds 4 times repeatedly to require a transmit frequency input.
4	Transmit freq. setting	Set transmit frequency to be stored using the tuning control, mic UP or DWN switch, or MHz key.
5	Memory input (transmit)	Depress the same key used in step 3. The 1.5 second beep sounds when the memory is input.

## ■ SCAN OPERATION

(1) Memory scan (Memory channels 1 – 5 are scanned.)

Before operating scan, adjust the SQUELCH control to the threshold point.

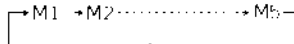
	Procedure	Operation	Indication
1	Scan start	Depressing the MS key initiates scan from memory channel 1 to 5 as shown.  Empty channels are skipped.	• Flashes
2		Scan will stop at busy station.	
3	Quick scan	Depressing the MS key recalls the next memory channel.	
4	Scan release	Depressing the A/B key or the mic PTT switch stops the scan. The displayed memory channel is restored to memory recall mode.	• Lights

To perform MS operation again, depress the A/B key to release MR operation.

## (2) Programmable scan

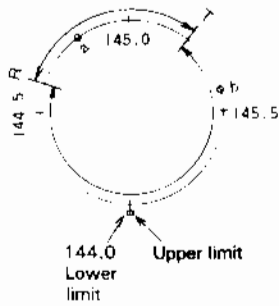

During VFO A or B operation, depressing and holding the mic UP or DWN switch for 1 second will initiate scan programmed within the range set between receive and transmit frequencies designated in memory channel 5.

As shown in the figure, R denotes the receive frequency in CH 5; T denotes the transmit frequency in CH 5.

i) When VFO is at point A, scan starts as shown.

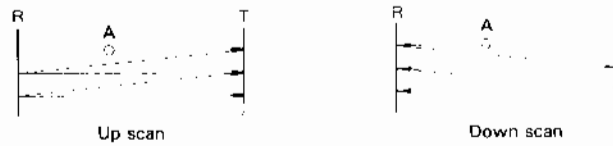

ii) When VFO is at point B, scan starts as shown.

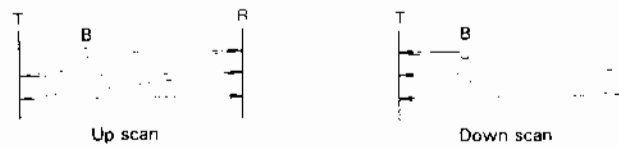

iii) When R and T are equal, scan operates through the whole frequency range.

	Procedure	Operation	Indication
1	Scan range setting	Store lower and upper limit frequencies in memory channel 5 by operating the M, M5, tuning control UP, DWN or MHz switch.	
2	Scan start	Hold the mic UP or DWN switch depressed for more than one second. The scan starts. The megahertz dot starts flashing.	• Flashes
3	Scan will stop at a busy station and resume in 6 seconds.		
4	Scan resume	Scan resumes regardless of signal when operating the tuning control or UP/DWN switch.	
5	Rapid scan	Holding the UP/DWN switch depressed allows rapid up or down scan. Holding the MHz key depressed allows rapid scan in 1 MHz steps.	
6	Scan direction	During up scan, depressing the DWN key or turning the tuning control one click to the left reverses the direction. During down scan, reversing the above procedure reverses the direction.	
7	Other scan range operation	Holding the UP/DWN key depressed allows the scan to go beyond the upper or lower frequency limit. Example: During up scan from R to T, hold the UP key depressed and allow the scan to go beyond T. The scan goes from T to R. (Outside the programmed limits)	
8	Scan release	Depressing the A/B key or mic PTT switch releases the scan. The flashing dot will stop.	• Lights



### (3) Releasing memory scan or programmable scan

To release scan operation, normally depress the A/B key or the mic PTT switch once. During scan, the mic PTT switch operation will release the scan but not transmit.

During scan operation, the following operations will release the scan.

- Depressing the COM\*, MR key.
- Turning off the POWER switch.
- Depressing the UP and DWN keys simultaneously during programmable scan.

## ■ ALERT OPERATION

Used to monitor the frequency stored in memory channel 1, whether or not it is busy, during any mode operation.

When memory channel 1 is busy, two beeps sound.

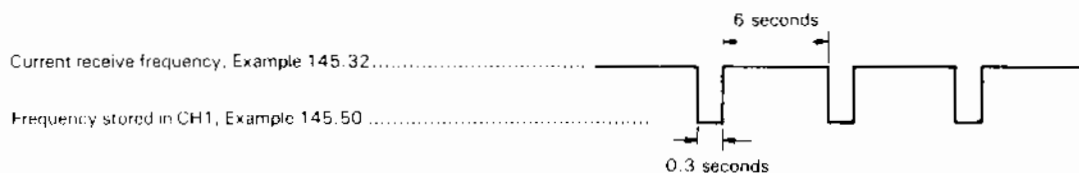

When the ALERT operation is in use, memory channel 1 is monitored once every 6 seconds. During this period, voice is silenced. **During the 3 seconds required to scan the priority channel key operation to inhibited.**

# 5. MAINTENANCE AND ADJUSTMENT

## ■ COVER REMOVAL

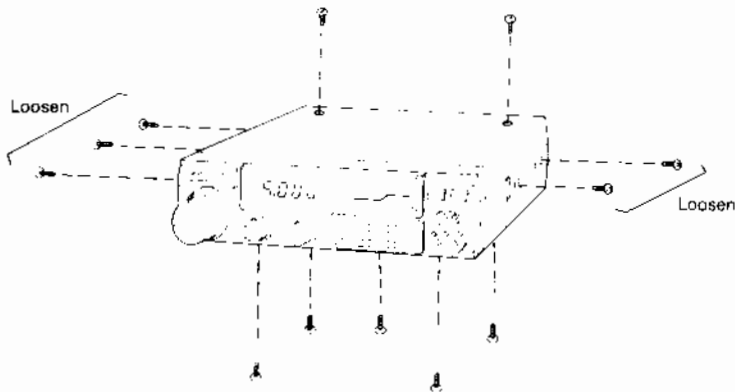

- 1 Loosen 5 screws ( $\phi 2.6 \times 5$  mm) of the side panels.
- 2 To remove the top cover, remove 2 screws ( $\phi 2.6 \times 5$  mm).
- 3 To remove the bottom cover, remove 5 screws ( $\phi 2.6 \times 5$  mm).

## ■ BEEPER ADJUSTMENT

Adjust VR1 on unit B (X53-1340-11/61) to the desired level.

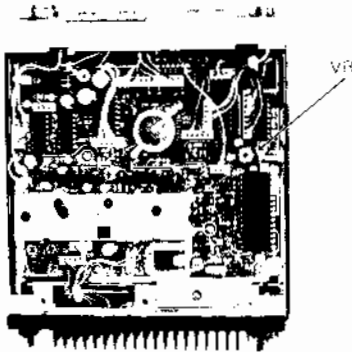

## ■ LITHIUM BATTERY

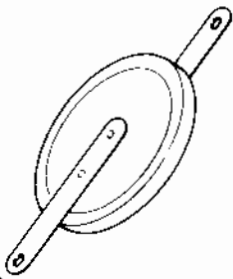

A lithium battery is contained in the transceiver to retain memory. Therefore, turning off the POWER switch, disconnecting the power cable, or a power failure will not clear the memory. The battery will last approximately five years. When the battery discharges an erroneous display may appear on the LCD. Lithium battery replacement should be performed by an authorized TRIO-KENWOOD service facility either your TRIO-KENWOOD dealer, or the factory.

**Note:**

When the lithium battery is replaced, the microprocessor must be reset.

**Note:**

Removing the battery does not require reprogramming the operating system, only your memory channel information etc.

## ■ MICROCOMPUTER RESET

Depress the reset switch with a nonconductive rod, through the reset opening of the bottom cover as shown.

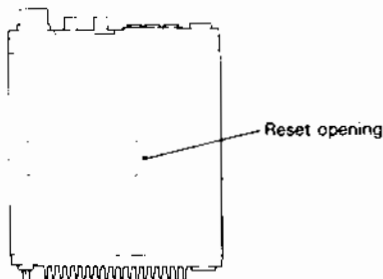

# 6. ACCESSORIES

## ■ USE OF THE REMOTE FREQUENCY CONTROL (OPTION)

Connecting the remote frequency control (FC-10) allows you to operate the transceiver more handily.

**Note:** When connecting or disconnecting the FC-10 from the transceiver, the POWER switch of the transceiver should be set to OFF, or the FC-10 may be damaged.

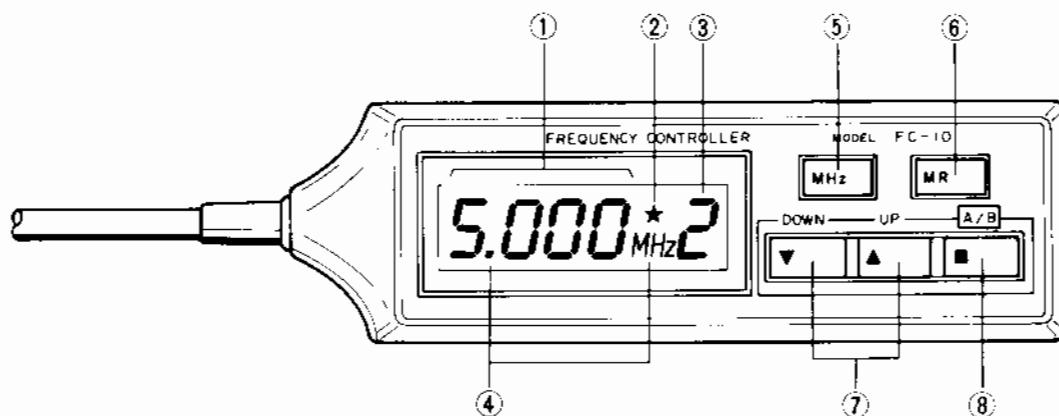

1) Display (The following numbers correspond to those in the figure above.)

- ① Frequency display: Indicates in four digits. Example: Indication 5 000 MHz denotes 145.0 MHz.
- ② ALERT display: During ALERT operation, the (★) lights.
- ③ VFO A/B: (A) denotes VFO A; (B) denotes VFO B. (C) denotes COM\* operation; (1 - 5) denotes memory channel 1 - 5.
- ④ Scan display: Flashes during scan operation. In memory scan, memory address is displayed at ③. In programmable scan, (A) or (B) is displayed at ③.

2) Keyboard

- ⑤ MHz key: When used, the VFO displayed frequency is shifted up in 1 MHz steps.
- ⑥ MR key: This key has two functions: Memory recall; and COM\* recall.

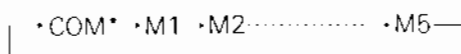

The VFO frequency is not memorized during [A/B] → [MR] → [A/B] key operation. After [A/B] key is pushed twice, push [MR] key so that the VFO frequency can be recalled.

- ⑦ UP/DWN key: These keys function the same as those of the microphone.
- ⑧ A/B key: This switch functions the same as that of the transceiver. With this switch, COM\* operation can be released.

■ PS-430 POWER SUPPLY

■ PG-3A LINE FILTER

■ MC-55 (8P) MOBILE MICROPHONE

■ MC-60A/80/85 DESK TOP MICROPHONE

■ MA-4000 MOBILE ANTENNA

■ SW-100A/100B SWR METER

■ SW-200A/200B SWR METER

■ SWT-1/SWT-2 ANTENNA TUNER

■ PG-2K DC CABLE

## ■ TU-3/TU-3A (TWO-TONE UNIT: OPTION)

### • Accessories

1. Diode Matrix (D9).....1
2. Adhesive Cushion.....1
3. Tone Frequency Name Plate.....1
4. Instruction Manual.....1

### • Tone Frequency Setting

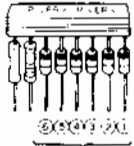

To set subtone, cut diode(s) according to the table.

Diode Matrix (D9) Setting

### • Tone unit Installation

1. Select the desired first tone frequency by cutting selected diodes from diode array D9, referring to the table.

**Example: To set to 94.8 Hz, cut D9 diodes as shown.**

To install D9, use a 45-W (or less) soldering pencil and solder carefully, heating the connections only long enough to insure a good solder joint. Do not over heat.



2. Select the desired second tone frequency by setting the 6-bit dip switch, referring to the table.

**Example: To set to 100.0 Hz, set the dip switch as shown.**



1. Install the supplied diode array D9 (frequency preset) in the TU-3 unit as shown.
2. Loosen five screws on both sides of the transceiver.
3. Remove two screws from the top cover. Lift the rear part of the cover and remove it.
4. Peel the waxed sheet off the cushion and affix the cushion to the TU-3 PC board.
5. Peel the waxed sheet off the cushion affixed to the TU-3 unit. Affix the TU-3 unit to the mounting space of the transceiver.
6. Plug the 5-pin connector into its mating jack on the TU-3 unit.
7. Replace the transceiver top cover and secure with two screws.
8. Tighten five screws on both side of the transceiver.
9. Affix the supplied tone frequency name plate on the transceiver bottom cover.

**Downloaded by  
RadioAmateur.EU**

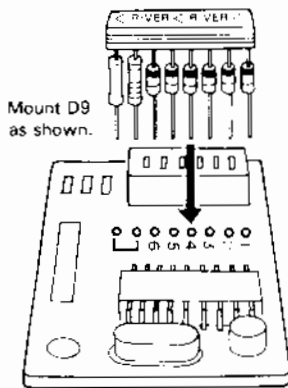

Mount D9 as shown.

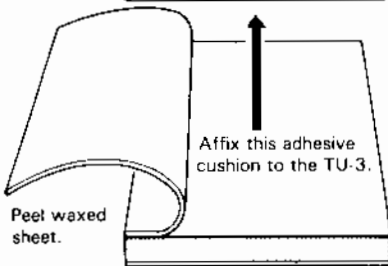

Affix this adhesive cushion to the TU-3.

Peel waxed sheet.

Cushion Attachment

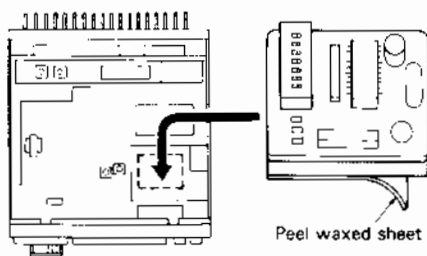

TU-3 Unit Installation

Peel waxed sheet

### EIA Specification Group

#	EIA Specification Group	Hz	Program Lines (ON=1, OFF=0)						#	EIA Specification Group	Hz	Program Lines (ON=1, OFF=0)					
			1	2	3	4	5	6				1	2	3	4	5	6
1	A	67.0	1	1	1	1	1	1	21	A	141.3	1	1	1	1	1	1
2	B	71.9	1	1	1	1	1	1	22	B	146.2	1	1	1	1	1	1
3	C	74.1	1	1	1	1	1	1	23	A	151.4	1	1	1	1	1	1
4	A	77	1	1	1	1	1	1	24	B	156.7	0	1	1	1	1	1
5	C	79.7	1	1	0	1	1	1	25	A	162.0	0	1	1	0	0	1
6	B	82.5	1	1	1	0	1	1	26	B	167.3	1	1	0	1	0	1
7	C	85.4	1	1	1	0	1	1	27	A	172.8	1	1	1	0	0	1
8	A	88.4	1	1	1	0	0	1	28	B	178.3	1	1	1	0	0	1
9	C	91.5	1	1	1	0	1	1	29	A	183.9	1	1	1	0	0	1
10	B	94.8	1	1	0	1	1	1	30	B	192.8	1	0	1	1	0	1
11	A	100.0	1	1	0	1	0	0	31	A	203.5	0	0	1	1	0	0
12	B	103.5	1	1	0	0	0	1	32	B	215.7	0	1	0	0	1	1
13	A	107.9	1	1	0	0	0	0	33	A	218.1	0	0	1	0	0	0
14	B	110.9	1	0	1	0	1	1	34	B	225.7	0	0	0	1	1	1
15	A	114.8	1	0	1	0	0	0	35	A	233.6	0	0	0	1	0	0
16	B	118.8	1	0	1	0	0	1	36	B	241.8	0	0	0	0	0	1
17	A	123.5	1	0	1	0	0	0	37	A	250.3	0	0	0	0	0	0
18	B	127.3	1	0	0	1	0	1									
19	A	131.8	1	0	0	1	0	0									
20	B	136.5	1	0	0	0	0	1									

---

## ■ GENERAL INFORMATION

Your TM-201B has been factory aligned and tested to specification before shipment. Under normal circumstances, the transceiver will operate in accordance with these operating instructions.

If your transceiver fails to work, contact the authorized dealer from which you purchased it for quick, reliable repair. All adjustable trimmers and coils in your transceiver were preset at the factory and should only be readjusted by a qualified technician with proper test equipment.

Attempting service or alignment without factory authorization, may void the warranty, proceed with caution!

## ■ HOW THE TX FINAL MODULE IS PROTECTED

Final module protection is provided by sampling the reflected power. As the reflected power is increased (higher SWR) transmitter drive is reduced, thus decreasing input to the final module. This in turn reduces collector loss, protecting the final transistor.

## ■ BATTERY PRECAUTION

When charging your vehicle battery, or when jumpstarting a dead battery, ALWAYS disconnect the power cable from the back of the transceiver, or serious damage may result.

## ■ ORDERING SPARE PARTS

When ordering replacement or spare parts for your equipment, be sure to specify the following:

- Model and serial number of your transceiver. Schematic number of the part. Printed circuit board number on which the part is located. Part number and name, if known, and quantity desired.

## ■ SERVICE

Should it ever become necessary to return the equipment for repair, pack it in its original box and packing, and include a full description of the problems involved. Also include your telephone number. You need not return accessory items unless directly related to the service problem. Tag all returned items with your call for identification.

Please mention the model and serial number of your radio in any correspondence, whether phone or written. For future reference, record this information in the space provided on the back cover of this manual.

**Note:**

**When claiming warranty service, a photocopy of the bill of sale, or other proof of purchase showing the date of sale, is required.**



# 8. SPECIFICATIONS

## [General]

Semiconductors .....	MPU	1
	ICs	18
	Transistors	48
	FETs	5
	Diodes	42
Frequency range .....	144.000 to 147.995 MHz	
Mode .....	FM (F3)	
Antenna impedance .....	50 ohms	
Power requirement .....	13.8V DC $\pm$ 15%	
Grounding .....	Negative	
Operating temperature .....	- 20°C to + 50°C	
External speaker impedance .....	8 ohms	
Current drain .....	0.5 A in receive mode with no input signal Max. 5.5 A in HI transmit mode 2.5 A in LOW transmit mode (Approx.)	
Dimensions .....	141 mm wide 39.5 mm high 200 mm deep (projections not included)	
Weight .....	1.2 kg (2.64 lbs)	

## [Transmitter]

RF output power (at 13.8V DC, 50 $\Omega$ load) .....	HI 45 Watts min. Low 5 Watts approx.
Modulation .....	Reactance
Frequency tolerance (- 20°C ~ + 50°C) .....	Less than $\pm 15 \times 10^{-6}$
Spurious radiation .....	HI Less than - 70 dB LOW Less than - 60 dB
Maximum frequency deviation (FM) .....	$\pm 5$ kHz
Audio distortion .....	3% max. (300 Hz ~ 3000 Hz)

## [Receiver]

Circuitry .....	Double superheterodyne
Intermediate frequency .....	1st 10.695 MHz 2nd 455 kHz
Receiver sensitivity .....	SINAD 12 dB less than 0.22 $\mu$ V S + N/N more than 50 dB at 1.0 mV input
Receiver selectivity .....	More than 12 kHz (- 6 dB) Less than 24 kHz (- 60 dB)
Spurious response .....	Better than 70 dB (except $f_0$ -IF/2)
Squelch sensitivity .....	Less than 0.16 $\mu$ V (threshold)
Auto scan stop level .....	Less than 0.2 $\mu$ V (threshold)
Audio output .....	More than 2.0 watts across 8 ohms load (5% dist.)

## [Auto patch microphone (MC-48) supplied] — For U.S.A. version only

Semiconductors .....	IC	1
	Transistors	3
	Diodes	3
Impedance .....	500 ohms	

Note: Circuit and ratings are subject to change without notice due to developments in technology.

Downloaded by  
RadioAmateur.EU

**Model TM-201B**

**Serial No.** \_\_\_\_\_

**Date of Purchase** \_\_\_\_\_

**Dealer** \_\_\_\_\_

## TRIO-KENWOOD CORPORATION

Shionogi Shibuya Building, 17-5, 2-chome Shibuya, Shibuya-ku, Tokyo 150, Japan

**TRIO-KENWOOD COMMUNICATIONS**

1111 West Walnut Street, Compton, California 90220, U.S.A.

**TRIO-KENWOOD COMMUNICATIONS**

**DIVISION OF TRIO-KENWOOD ELECTRONICS GmbH**

Rembrücker Str. 15, 6056 Heusenstamm, West Germany

**TRIO-KENWOOD ELECTRONICS, N.V.**

Leuvensesteenweg 504, B-1930 Zaventem Belgium

**TRIO-KENWOOD (AUSTRALIA) PTY. LTD. (INCORPORATED IN N.S.W.)**

4E, Woodcock Place, Lane Cove, N.S.W. 2066, Australia



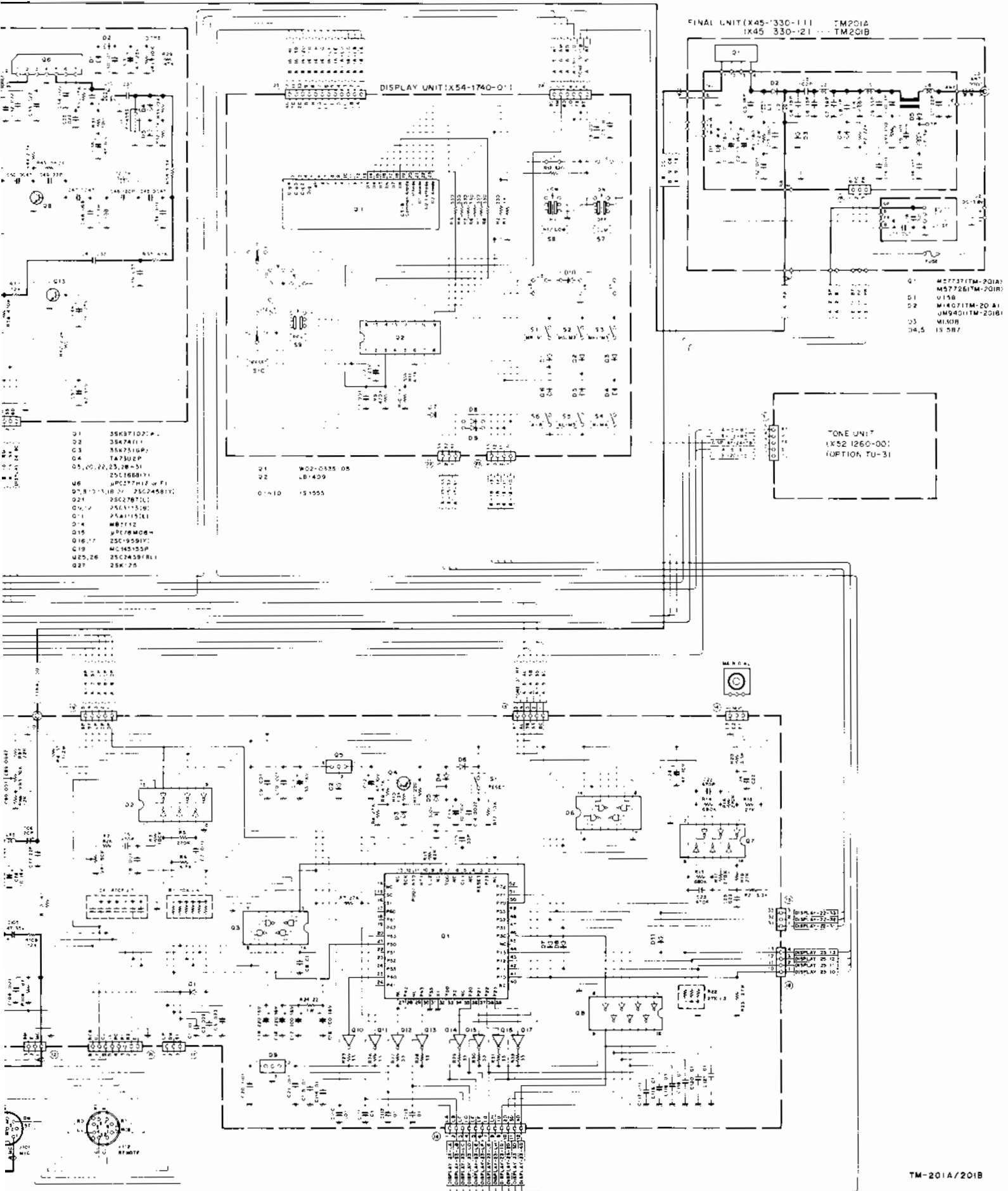

- Q1 35K7102P
- Q2 35K7411
- Q3 35K7516P
- Q4 TA7502P
- Q5, Q6, Q7, Q8, Q9, Q10, Q11, Q12, Q13, Q14, Q15, Q16, Q17, Q18, Q19, Q20, Q21, Q22, Q23, Q24, Q25, Q26, Q27

- Q1 W02-0335 08
- Q2 LB-409
- Q1+10 1S-1555

- FINAL UNIT (X45-330-111) TM201A  
 (X45-330-21) TM201B
- Q1 M07737(TM-201A)
  - M57726(TM-201B)
  - Q1 V15B
  - Q2 M14071(TM-20 A)
  - UM9401(TM-201B)
  - M100B
  - Q4,5 1S-5B7

TONE UNIT  
 (X52-1260-00)  
 (OPTION TU-3)

# SCHEMATIC DIAGRAM

