

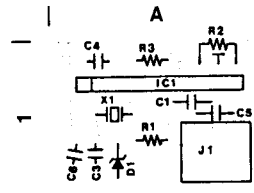

ICOM

### tone call unit



### SENSOR BOARD

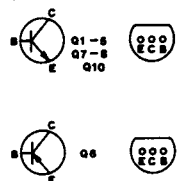
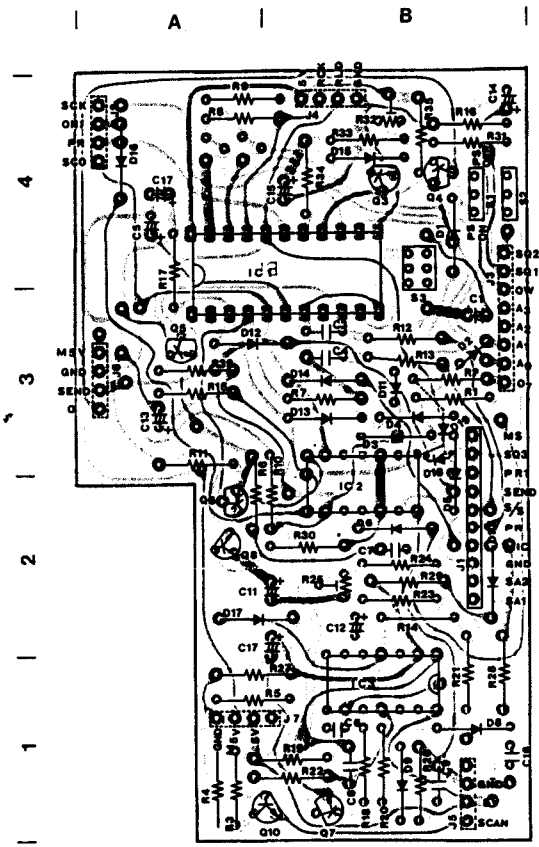

D E

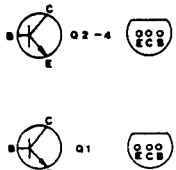
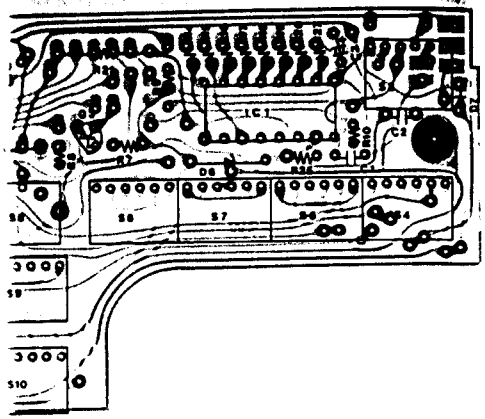

F

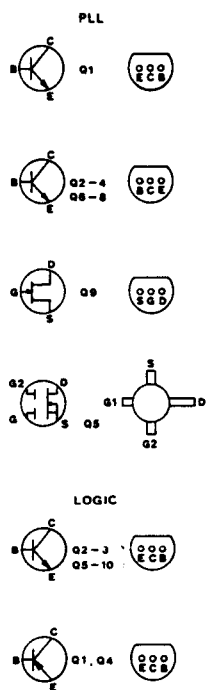
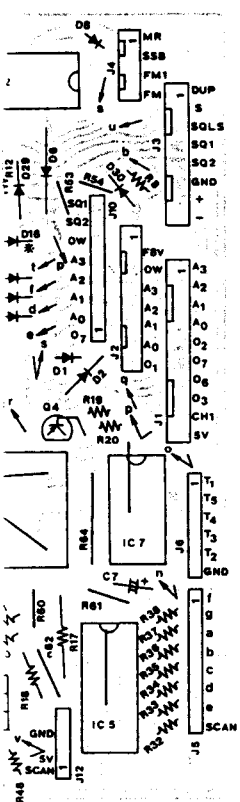

\* USA ONLY  
\* EUR ONLY

### UNIT LAYOUT

LED BOARD



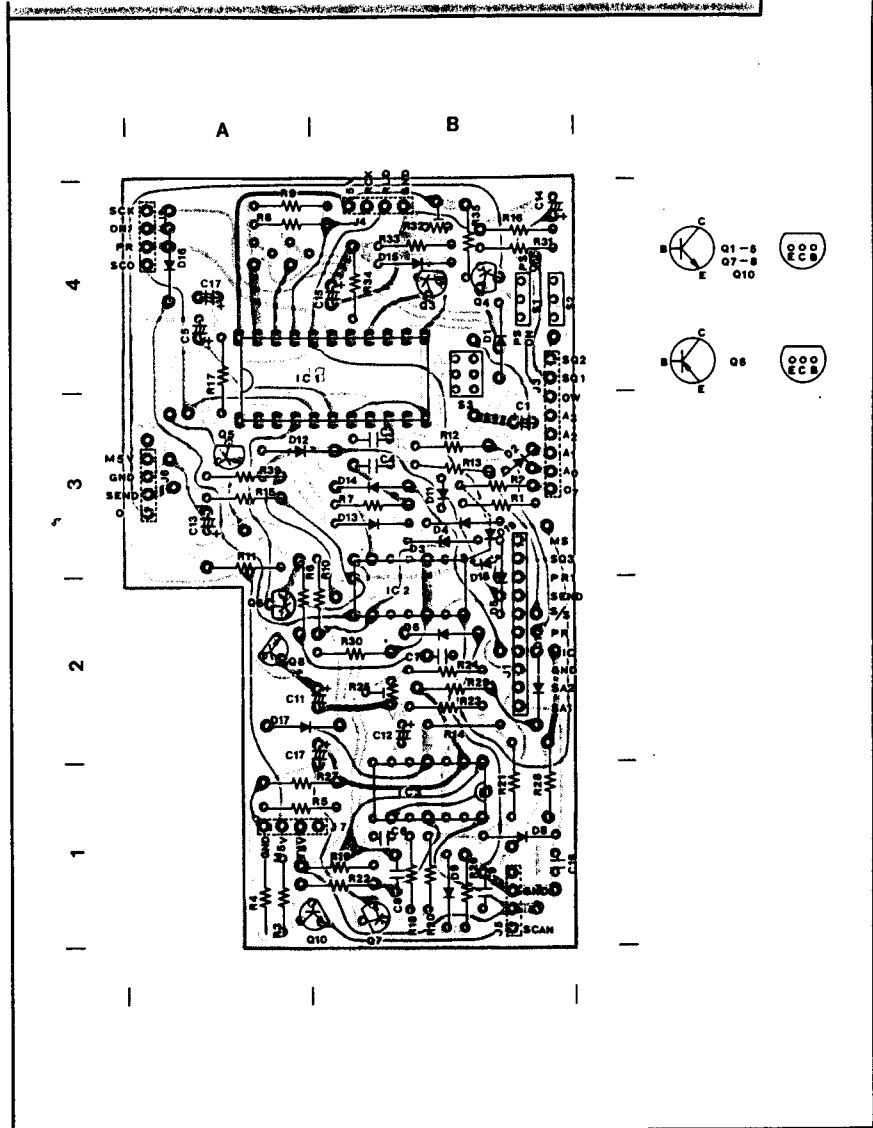
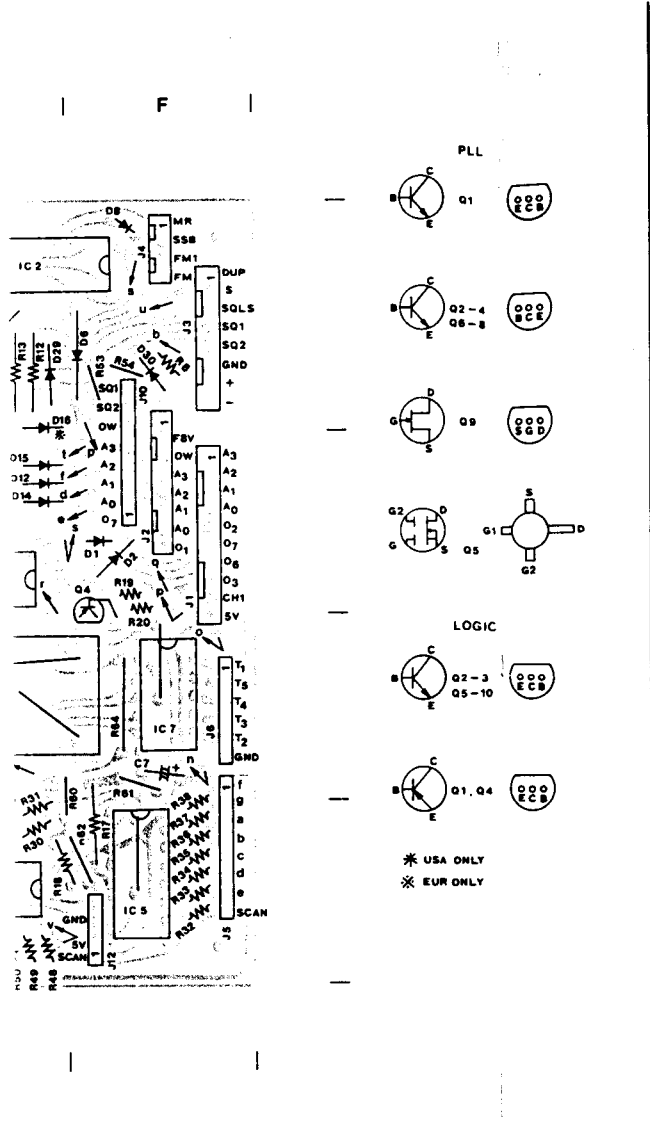

**UNIT LAYOUT**

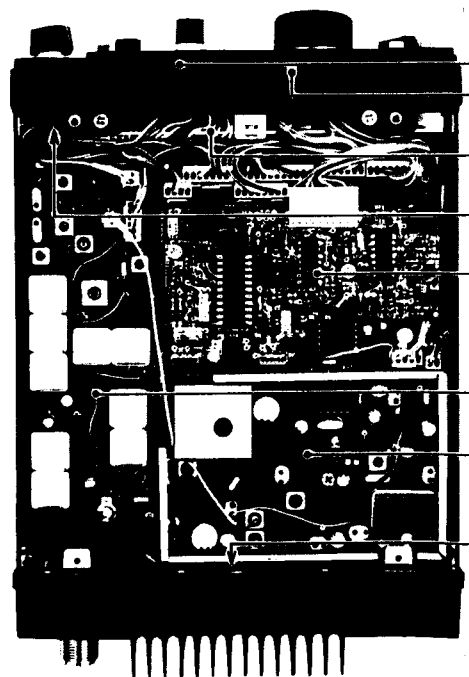

- LED BOARD
- DISPLAY BOARD
- F SW BOARD
- CH SW BOARD
- SENSOR UNIT
- RF·YGR UNIT
- PLL·LOGIC UNIT
- PA UNIT

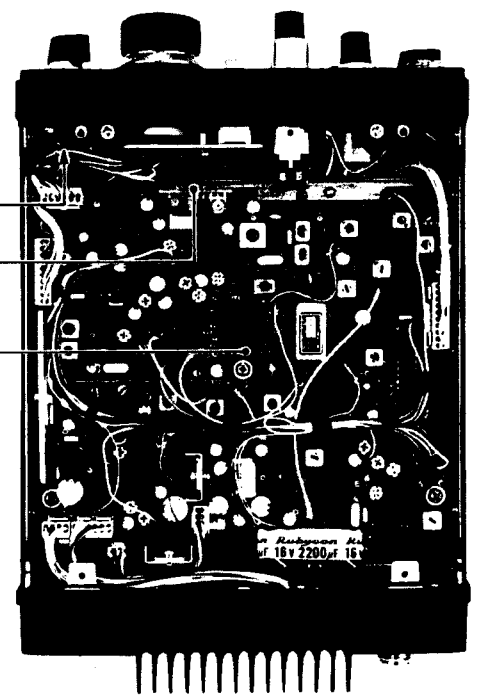

- M SW BOARD
- TONE CALL UNIT
- MAIN UNIT

**ICOM INCORPORATED**

Some components subject to change for an improvement without notice.

Printed in Japan

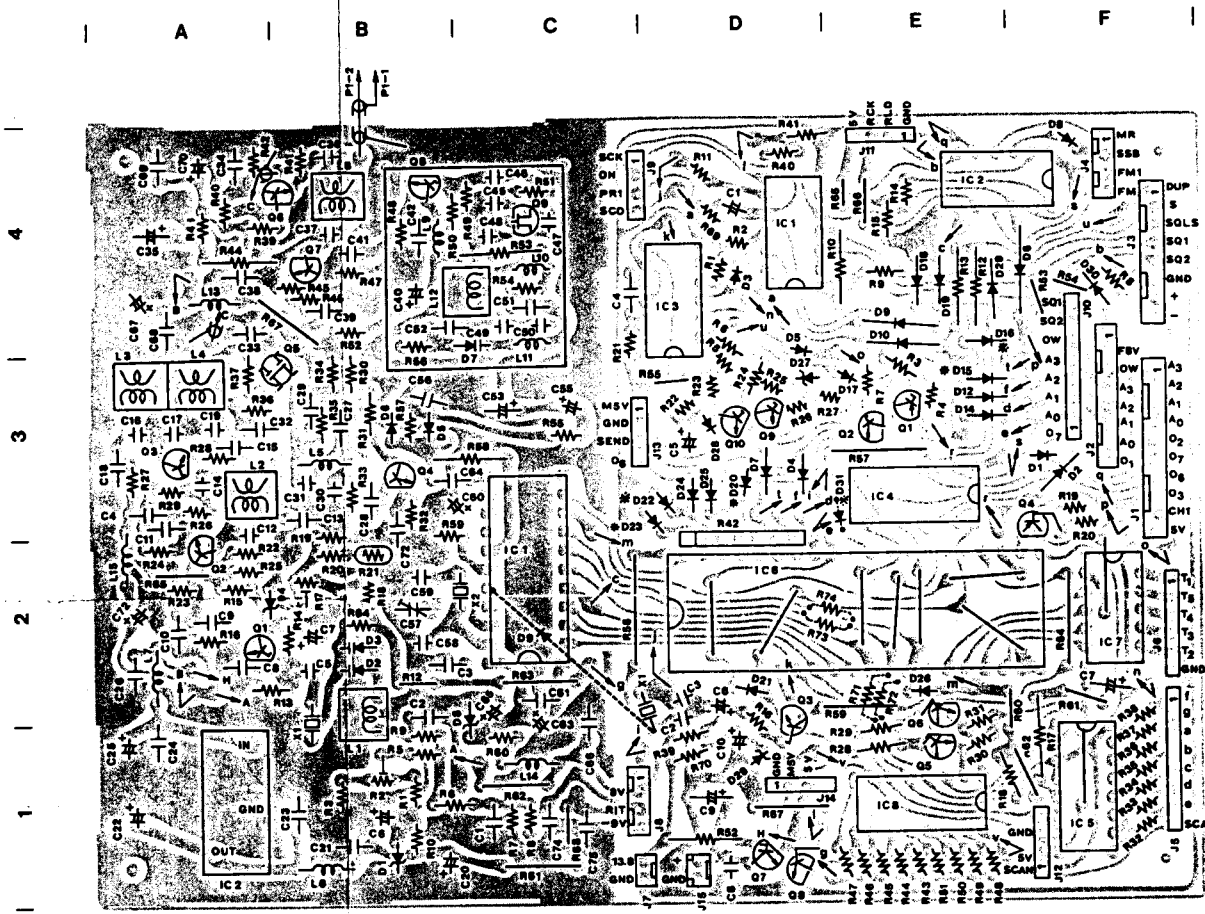

### PA UNIT

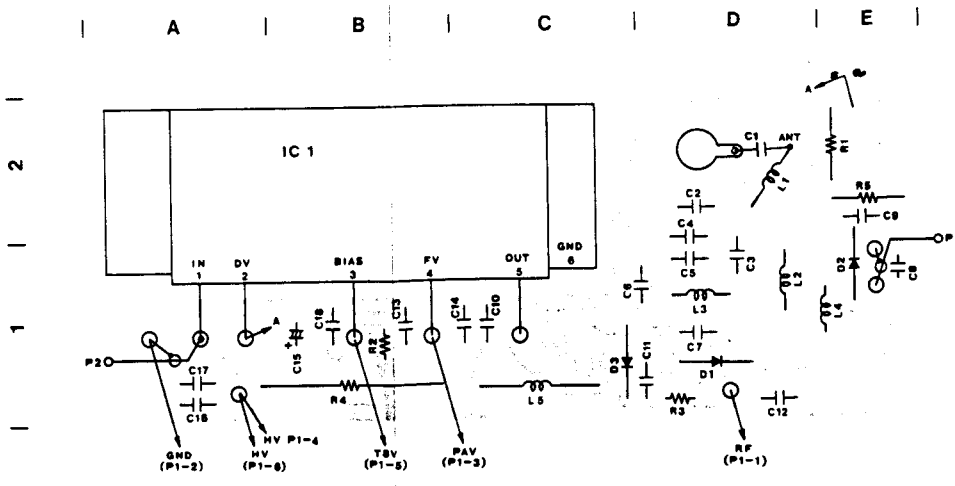

### UNIT LAYOUT

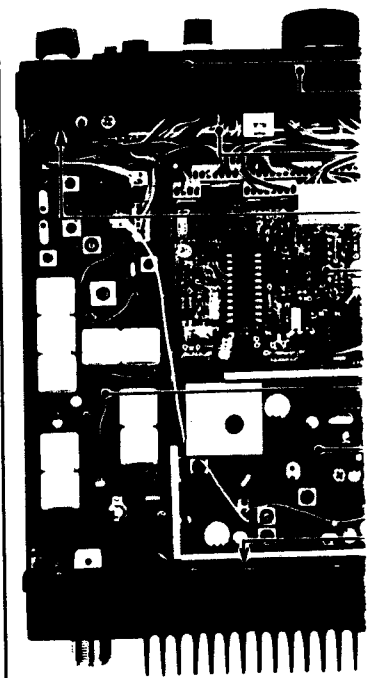

A | B | C | D | E | F

5  
4  
3  
2  
1

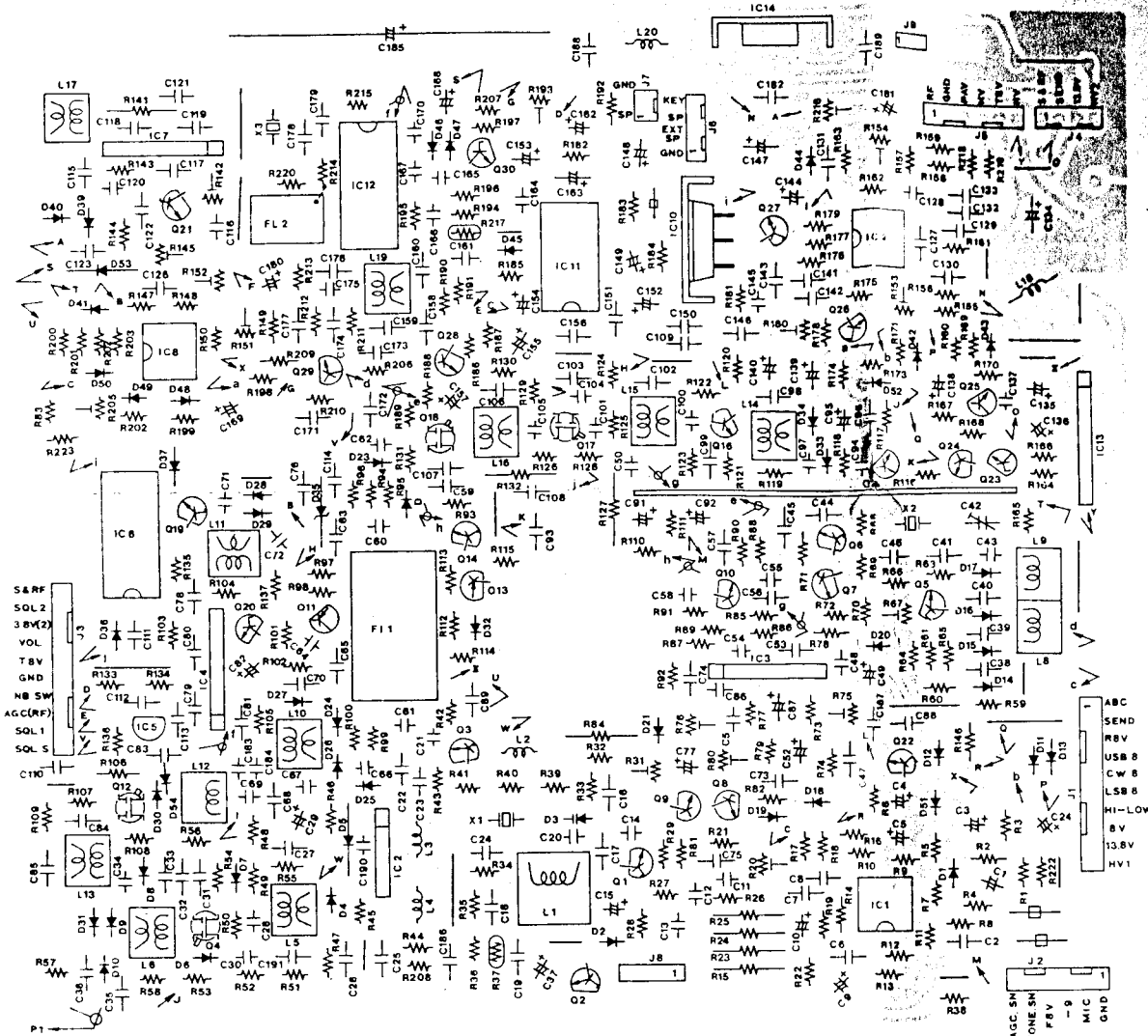

A | B | C | D | E | F

2  
1

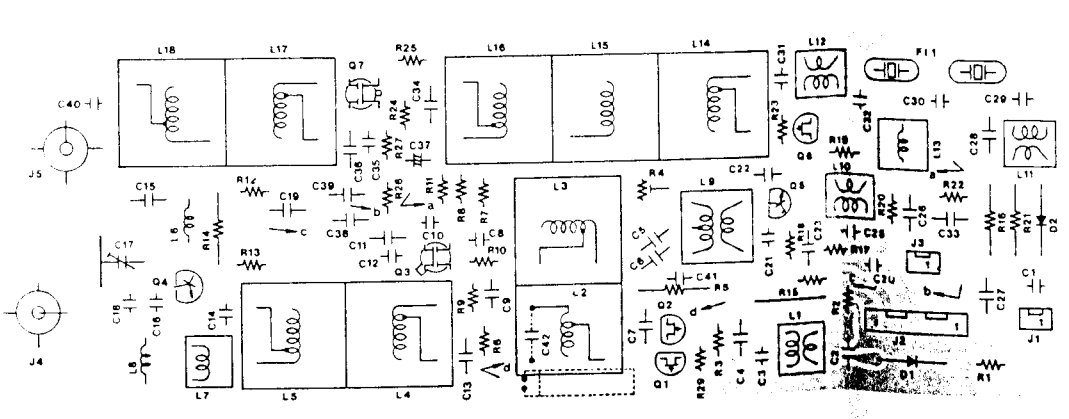

# IC-290A/E

# BOARD LAY

## EF UNIT

### CH SW BOARD

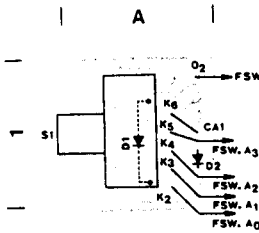

### LED BOARD

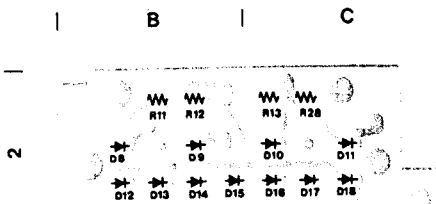

### DISPLAY BOARD

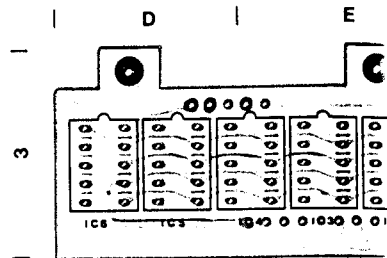

## MAIN UNIT

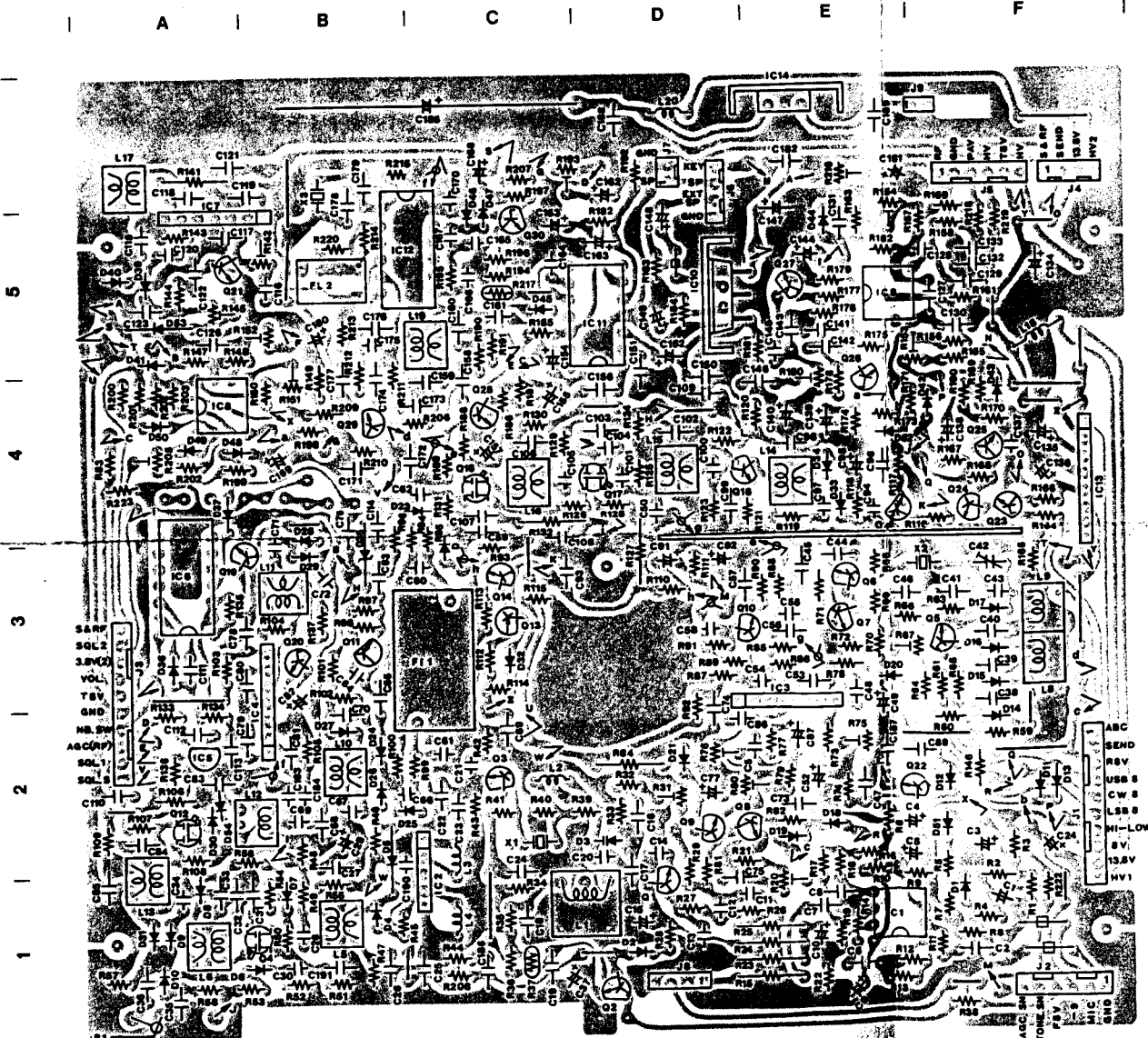

# LAYOUT

## Y BOARD

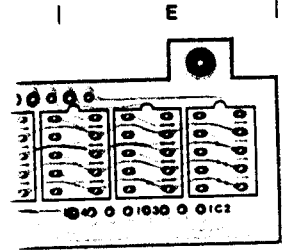

## M SW BOARD

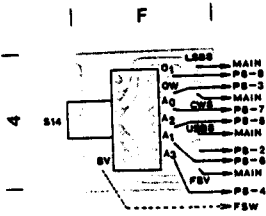

## F SW BOARD

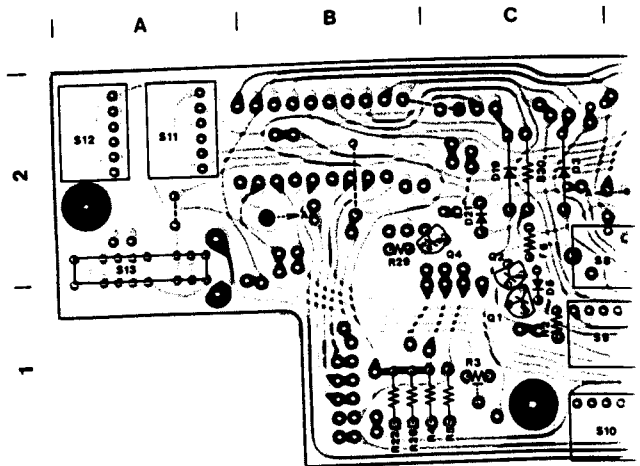

## PLL LOGIC UNIT

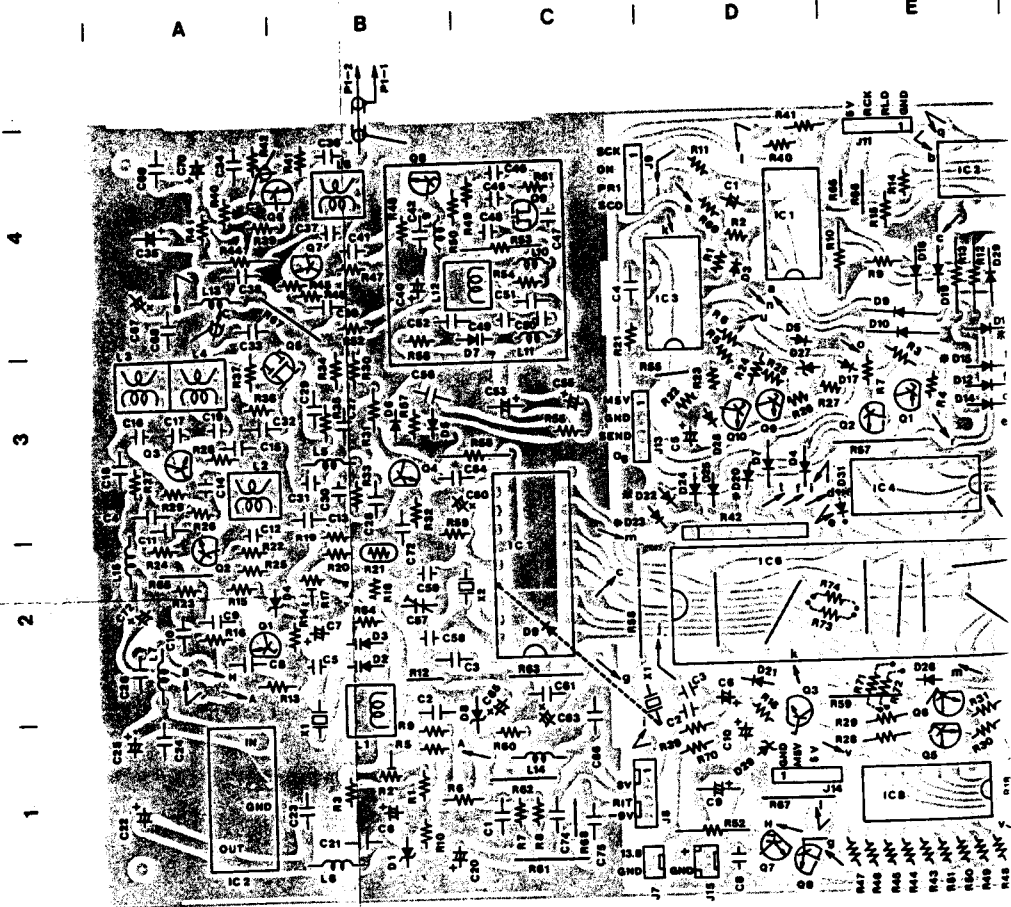

## PA UNIT

