

YAESU
The radio

FTM-3207DR/DE

Operating Manual

**UHF DIGITAL/ANALOG TRANSCEIVER
C4FM/FM**

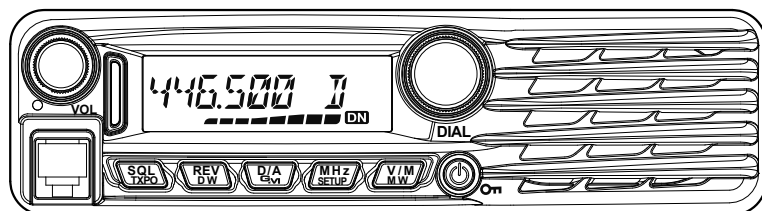

Contents

Safety Precautions (Be Sure to Read)	3	DCS Operation	28
FTM-3207DR/DE Quick Reference Guide	5	DCS Search	29
Introduction	6	EPCS (Enhanced Paging & Code Squelch) Operation	29
Features of this radio	6	Split Tone Operation	29
Accessories & Options	7	DTMF Operation	29
Supplied Accessories	7	Memory Operation	30
Optional Accessories	7	Memory Storage	30
Installation	8	Split Memory	30
Connecting the Microphone	8	Naming a Memory Channel	30
Connecting the Antenna	8	Memory Recall.....	31
Mobile Installation.....	9	Memory Recall from the Microphone Keypad.....	31
Power connection	10	Moving Memory Data to the VFO	31
Base Station Installation	11	Memory Only Mode	31
AC Power Supplies.....	11	Masking Memories	32
Front Panel Controls & Switches	12	Unmasking Memories.....	32
Front Panel	12	HOME Channel Memory	32
Microphone Switches	14	Changing the frequency of the home channel.....	32
Microphone (MH-48A6JA).....	14	Scanning	33
[P1] button	14	Basic Scanner Operation	33
[P2] button	14	Scan Resume Options	33
[P3] button (Wires-X).....	14	Memory Skip Scanning.....	33
[P4] button (TX PW/T.CALL).....	14	Preferential Memory Scan	33
Rear Panel Connectors	15	Programmable Memory Scan (PMS).....	33
Rear Panel.....	15	Priority Channel Scanning (Dual Watch).....	33
Basic Operation	16	GM Function	34
Turning the Transceiver ON and OFF	16	What is the GM (Group Monitor) Function?.....	34
Inputting the call sign	16	Displaying all the stations using the GM function	34
Adjusting the Audio Volume Level	16	Reset Procedure/Clone	35
Adjusting the Squelch Setting.....	16	Reset Procedure	35
Frequency Navigation.....	17	Microprocessor Resetting.....	35
Using the Dial	17	Setup (Menu) Mode Resetting.....	35
Using the MH-48A6JA Microphone.....	17	Clone	35
Channel Step Selection	17	Connecting the WIRES-X feature	36
Selecting the communication mode.....	18	What is WIRES-X?	36
Setting the transmission mode when using the AMS function	19	Connecting to a WIRES-X digital node (Recommended).....	36
Transmission	20	Connecting to the other node ID or the other room ID.....	36
Adjusting the transmit power	21	Connect and communicate with WIRES-X in analog mode	39
Lock Feature.....	21	Disconnecting from the node or room.....	39
Advanced Operation	22	Miscellaneous Settings	40
About the Digital Group ID (DG-ID) feature	22	Programming the Key Assignments	40
Register the DG-ID number in the DG-ID memory.....	22	Keyboard Beeper.....	40
Recall and use the DG-ID number registered in the DG-ID memory.....	23	Display Brightness.....	40
Restore the DG-ID number to "00" for both transmit and receive without using the DG-ID memory.....	24	Time-Out-Timer (TOT).....	40
Use the GM (Group Monitor) with the DG-ID function	24	Automatic Power Off (APO).....	40
Digital Personal ID (DP-ID) feature	25	Busy Channel Lock-Out (BCLO)	40
Registering the DP-ID to a DR-2X digital repeater	25	TX Deviation Level	40
Register the transceivers	25	MIC Gain Setting	40
Deleting the registered DP-ID.....	26	Displaying the Supply Voltage.....	41
Advanced Operation	27	Displaying the Temperature	41
Repeater Operation	27	Band Edge Beeper	41
Checking the Repeater	27	Setup (Menu) Mode	42
Uplink (Input) Frequency	27	Maintenance	45
Tone Calling (1750 Hz)	27	Care and maintenance	45
CTCSS Operation.....	28	Replacing the fuse	45
Tone Search.....	28	Replacing the fuse of the DC power supply cable.....	45

Safety Precautions (Be Sure to Read)

Be sure to read these important precautions, and use this product safely.

Yaesu is not liable for any failures or problems caused by the use or misuse of this product by the purchaser or any third party. Also, Yaesu is not liable for damages caused through the use of this product by the purchaser or any third party, except in cases where ordered to pay damages under the laws.

Types and meanings of the marks



DANGER

This mark indicates an imminently hazardous situation, which, if not avoided, could result in death or serious injury.



WARNING

This mark indicates a potentially hazardous situation, which, if not avoided, could result in death or serious injury.



CAUTION

This mark indicates a potentially hazardous situation, which, if not avoided, may result in minor or moderate injury or only property damage.

Types and meanings of symbols



These symbols signify prohibited actions, which must not be done to use this product safely. For example:  indicates that the product should not be disassembled.



These symbols signify required actions, which must be done to use this product safely. For example:  indicates that the power plug should be disconnected.



DANGER



Do not use the device in "regions or aircrafts and vehicles where its use is prohibited" such as in hospitals and airplanes.

This may exert an impact on electronic and medical devices.



Do not use this product while driving or riding a motorbike. This may result in accidents.

Make sure to stop the car in a safe location first before use if the device is going to be used by the driver.



Do not operate the device when flammable gas is generated.

Doing so may result in fire and explosion.



Never touch the antenna during transmission.

This may result in injury, electric shock and equipment failure.



Do not transmit in crowded places in consideration of people who are fitted with medical devices such as heart pacemakers.

Electromagnetic waves from the device may affect the medical device, resulting in accidents caused by malfunctions.



When an alarm goes off with the external antenna connected, cut off the power supply to this radio immediately and disconnect the external antenna from this radio.

If not, this may result in fire, electric shock and equipment failure.



Do not touch any liquid leaking from the liquid display with your bare hands.

There is a risk of chemical burns occurring when the liquid comes into contact with the skin or gets into the eyes. In this case, seek medical treatment immediately.



WARNING



Do not use voltages other than the specified power supply voltage.

Doing so may result in fire and electric shock.



Do not transmit continuously for long periods of time.

This may cause the temperature of the main body to rise and result in burns and failures due to overheating.



Do not dismantle or modify the device.

This may result in injury, electric shock and equipment failure.



Do not handle the power plug and connector etc. with wet hands. Also do not plug and unplug the power plug with wet hands.

This may result in injury, liquid leak, electric shock and equipment failure.



When smoke or strange odors are emitted from the radio, turn off the power and disconnect the power cord from the socket.

This may result in fire, liquid leak, overheating, damage, ignition and equipment failure. Please contact our company amateur customer support or the retail store where you purchased the device.



Keep the power plug pins and the surrounding areas clean at all times.

This may result in fire, liquid leak, overheating, breakage, ignition etc.



Disconnect the power cord and connection cables before incorporating items sold separately and replacing the fuse.

This may result in fire, electric shock and equipment failure.



Never cut off the fuse holder of the DC power cord.

This may cause short-circuiting and result in ignition and fire.



Do not use fuses other than those specified.

Doing so may result in fire and equipment failure.



Do not allow metallic objects such as wires and water to get inside the product.

This may result in fire, electric shock and equipment failure.



Do not place the device in areas that may get wet easily (e.g. near a humidifier).

This may result in fire, electric shock and equipment failure.



When connecting a DC power cord, pay due care not to mix up the positive and negative polarities.

This may result in fire, electric shock and equipment failure.



Do not use DC power cords other than the one enclosed or specified.

This may result in fire, electric shock and equipment failure.



Do not bend, twist, pull, heat and modify the power cord and connection cables in an unreasonable manner.

This may cut or damage the cables and result in fire, electric shock and equipment failure.



Do not pull the cable when plugging and unplugging the power cord and connection cables.

Please hold the plug or connector when unplugging. If not, this may result in fire, electric shock and equipment failure.



Refrain from using headphones and earphones at a loud volume.

Continuous exposure to loud volumes may result in hearing impairment.



Do not use the device when the power cord and connection cables are damaged, and when the DC power connector cannot be plugged in tightly.

Please contact our company amateur customer support or the retail store where you purchased the device as this may result in fire, electric shock and equipment failure.



Follow the instructions given when installing items sold separately and replacing the fuse.

This may result in fire, electric shock and equipment failure.



Do not use the device when the alarm goes off.

For safety reasons, please pull the power plug of the DC power equipment connected to the product out of the AC socket.

Never touch the antenna as well. This may result in fire, electric shock and equipment failure due to thunder.



CAUTION



Do not place this device near a heating instrument or in a location exposed to direct sunlight.

This may result in deformation and discoloration.



Do not place this device in a location where there is a lot of dust and humidity.

Doing so may result in fire and equipment failure.



Stay as far away from the antenna as possible during transmission.

Long-term exposure to electromagnetic radiation may have a negative effect on the human body.



Do not wipe the case using thinner and benzene etc.

Please use a soft and dry piece of cloth to wipe away the stains on the case.



Keep out of the reach of small children.

If not, this may result in injuries to children.



Do not put heavy objects on top of the power cord and connection cables.

This may damage the power cord and connection cables, resulting in fire and electric shock.



Do not transmit near the television and radio.

This may result in electromagnetic interference.



Do not use optional products other than those specified by our company.

If not, this may result in equipment failure.



When using the device in a hybrid car or fuel-saving car, make sure to check with the car manufacturer before using.

The device may not be able to receive transmissions normally due to the influence of noises from the electrical devices (inverters etc.) fitted in the car.



For safety reasons, switch off the power and pull out the DC power cord connected to the DC power connector when the device is not going to be used for a long period of time.

If not, this may result in fire and overheating.



Do not throw or subject the device to strong impact forces.

This may result in equipment failure.



Do not put this device near magnetic cards and video tapes.

The data in the cash card and video tape etc. may be erased.



Do not turn on the volume too high when using a headphone or earphone.

This may result in hearing impairment.



Do not place the device on an unsteady or sloping surface, or in a location where there is a lot of vibration.

The device may fall over or drop, resulting in fire, injury and equipment failure.



Do not stand on top of the product, and do not place heavy objects on top or insert objects inside it.

If not, this may result in equipment failure.



Do not use a microphone other than those specified when connecting a microphone to the device.

If not, this may result in equipment failure.



Do not touch the heat radiating parts.

When used for a long period of time, the temperature of the heat radiating parts will get higher, resulting in burns when touched.



Do not open the case of the product except when replacing the fuse and when installing items sold separately.

This may result in injury, electric shock and equipment failure.

② VOL Knob

Adjusts the audio volume level.

③ Frequency DIAL Knob

Selects the operating Frequency.

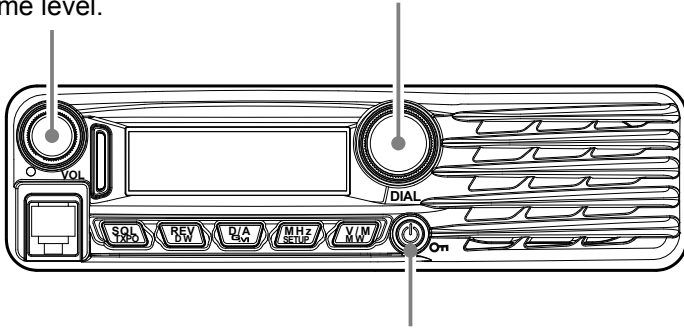

① Power Switch

Press and hold for one second.

④ Transmission Switch

Speak into the microphone in a normal voice level while pressing this switch.

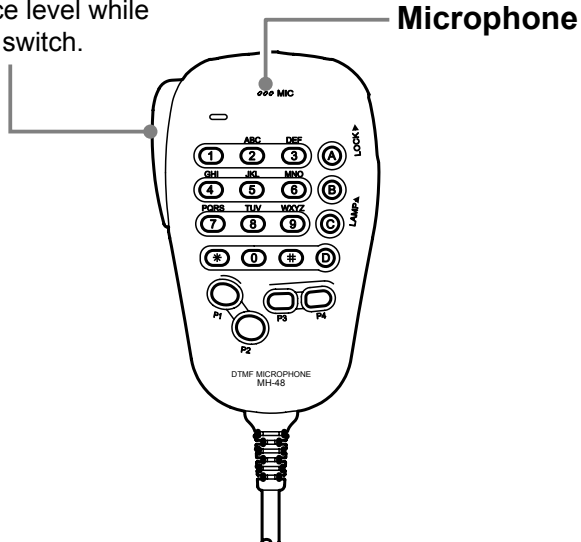

Features of this radio

- 430 MHz mobile radio, equipped with a C4FM communication modem
- 55 Watts of power output, with selection of three power levels for every operating situation
- Clear audio and data communication is achieved using the C4FM modem functions
- Expanded receiver coverage: 420-470 MHz
- With the GD-ID (Digital Group ID) feature, the Group Monitor (GM) feature enables automatically locating, and communicating with other stations that have the same DG-ID number within contact range, by utilizing a matching group ID number from 00 to 99.
- The Digital Personal ID (DP-ID) feature supports communication specifically with transceivers registered with the individual ID information. The DP-ID is different for each transceiver and is included in each C4FM transmission.
- Easily connect with the WIRES-X linking system
- Keyboard entry of operating frequencies from the microphone
- 220 memories (199 “basic” memory channels, 10 sets of band-edge memory channels, and one “Home” channel) which can store repeater shifts, odd repeater shifts, CTCSS/DCS tones, and 8-character Alpha-Numeric labels for easy channel recognition
- Built-in CTCSS and DCS Encoder/Decoder circuits
- Extensive Menu system, which allows customization of a number of transceiver performance characteristics
- Equipped with the GM (Group Monitor) function

Additional features include a transmit Time-Out-Timer (TOT), Automatic Power-Off (APO), and Automatic Repeater Shift (ARS). Also included is an RF Squelch circuit that allows the owner to set the squelch to open at a programmed setting of the S-Meter, thus reducing guesswork in setting the squelch threshold.

Congratulations on your purchase of the FTM-3207DR/DE! Whether this is your first rig, or if Yaesu equipment is already the backbone of your station, the Yaesu organization is committed to ensuring your enjoyment of this high-performance transceiver. It should provide you with many years of satisfying operation. Our dealer network and technical support personnel stand behind every product we sell, and we invite you to contact us should you require technical advice or assistance.

We recommend that you read this manual in its entirety prior to installing the FTM-3207DR/DE, so that you fully understand the capabilities of your new transceiver.

Supplied Accessories

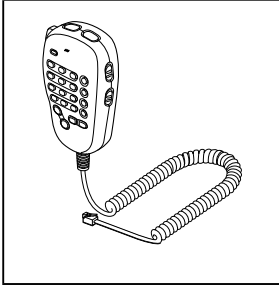

DTMF Microphone
MH-48A6JA

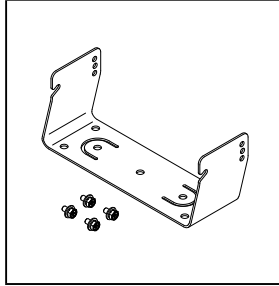

Mobile Mounting Bracket
(Attachment screw set)

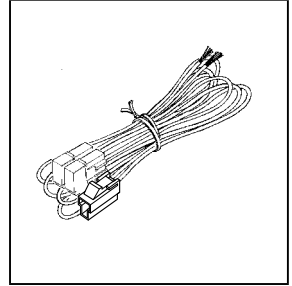

DC power cable w/Fuse

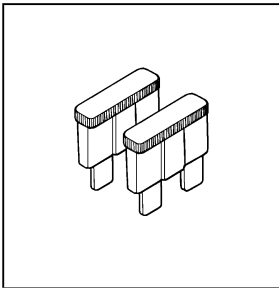

Spare fuse (25 A)
(20 A, European version)

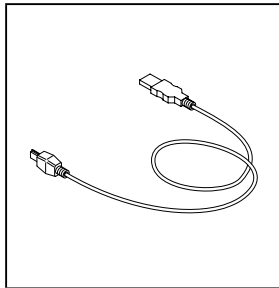

USB cable

Operating Manual
Warranty Card

Optional Accessories

MH-42C6J	Microphone
MH-48A6JA	DTMF Microphone
MLS-100	High-Power External Speaker
FP-1030A	AC Power Supply (USA/EXP market only)

Installation

Connecting the Microphone

Connect the supplied MH-48A6JA microphone to the FTM-3207DR/DE.
Plug the microphone connector into the MIC jack on the front panel until it clicks.

Note: When disconnecting the microphone, pull the cable while pressing the connector latch.

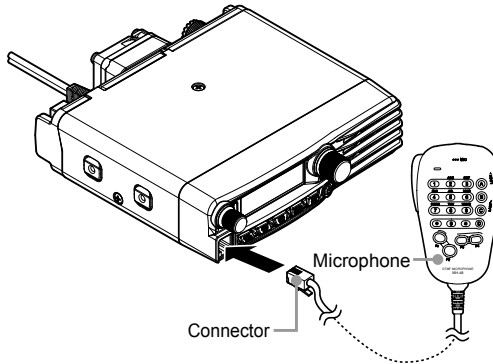

Connecting the Antenna

Connect the coaxial cable to the body.
Plug the coaxial cable jack into the ANT terminal on the rear panel of the body, then rotate and tighten it.

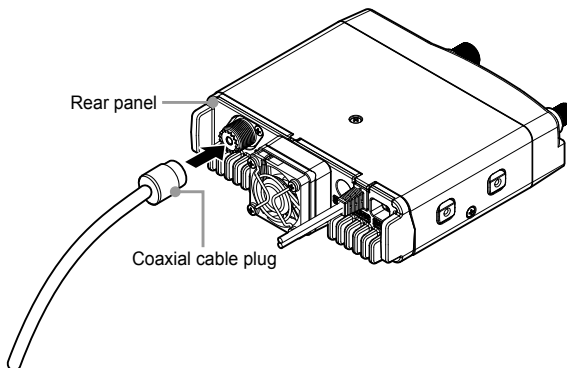

Mobile Installation

The FTM-3207DR/DE must only be installed in vehicles having a 13.8 Volt negative ground electrical system. Mount the transceiver where the display, controls, and microphone are easily accessible, using the supplied mounting bracket.

The transceiver may be installed in almost any location, but should not be positioned near a heating vent nor anywhere where it might interfere with driving (either visually or mechanically).

Make sure to provide plenty of space on all sides of the transceiver so that air can flow freely around the radio's case. Refer to the diagrams showing proper installation procedures.

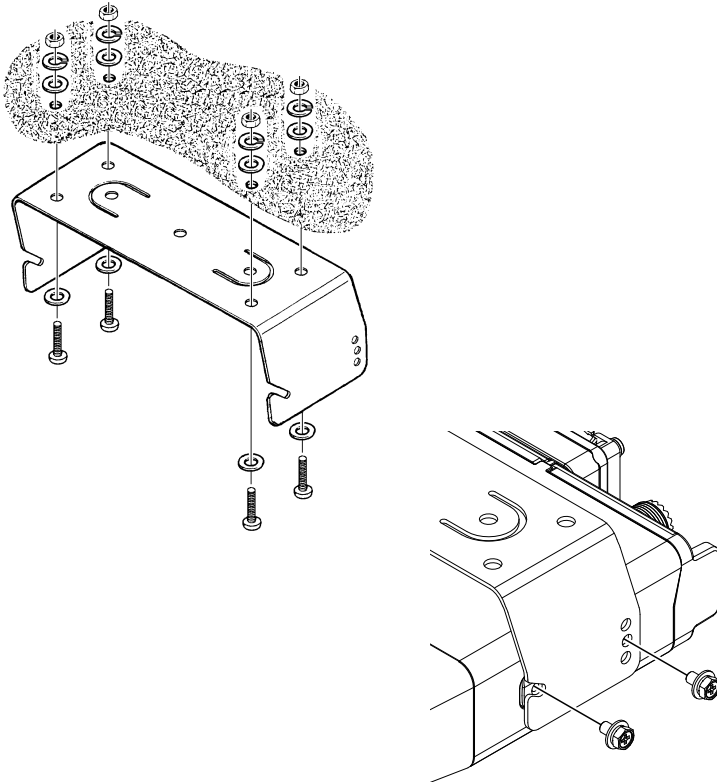

Installation

Power connection

To minimize voltage drop and avoid blowing the vehicle's fuses, connect the supplied DC power cable directly to the battery terminals. Do not attempt to defeat or bypass the DC cable fuse - it is there to protect you, your transceiver, and your vehicle's electrical system.

Warning!

Never apply AC power to the power cable of the FTM-3207DR/DE, nor DC voltage greater than 15.8 Volts. When replacing the fuse, only use a 25-A (20-A, European version) fuse. Failure to observe these safety precautions will void the Limited Warranty on this product.

- Before connecting the transceiver, check the voltage at the battery terminals while revving the engine. If the voltage exceeds 15 Volts, adjust the vehicle's voltage regulator before proceeding with installation.
- Connect the **RED** power cable lead to the **POSITIVE (+)** battery terminal, and the **BLACK** power cable lead to the **NEGATIVE (-)** terminal. If you need to extend the power cable, use #12 AWG or larger insulated, stranded copper wire. Solder the splice connections carefully, and wrap the connections thoroughly with insulating electrical tape.
- Before connecting the cable to the transceiver, verify the voltage and polarity at the voltage at the transceiver end of the DC cable, using a DC voltmeter. Now connect the transceiver to the DC cable.

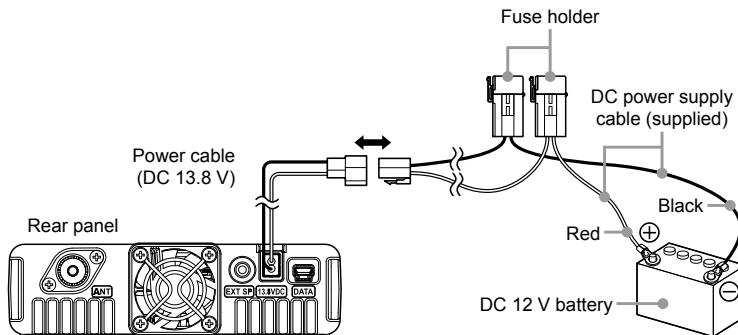

Warning!

- **Do not use a DC power supply cable other than the one that is supplied or specified.**
- **Do not place anything on the DC power supply cable or step on it.**
- **Do not use the DC power supply cable with the fuse holder cut off.**
- **Do not reverse the polarity (positive and negative) when connecting the battery.**

Base Station Installation

The FTM-3207DR/DE is ideal for base station use as well as in mobile installations. The FTM-3207DR/DE is specifically designed to integrate into your station easily, using the following information as a reference.

AC Power Supplies

Operation of the FTM-3207DR/DE from an AC line requires a power source capable of providing at least 20 Amps continuously at 13.8 Volts DC. The FP-1023 (USA market only) and FP-1030A (USA/EXP market only) AC Power Supplies are available from your Yaesu dealer to satisfy these requirements. Other well-regulated power supplies may be used as well, if they meet the above voltage and current specifications.

Use the DC power cable supplied with the transceiver to make the power connection to the power supply. Connect the **RED** power cable lead to the **POSITIVE (+)** power supply terminal, and connect the **BLACK** power cable lead to the **NEGATIVE (-)** power supply terminal.

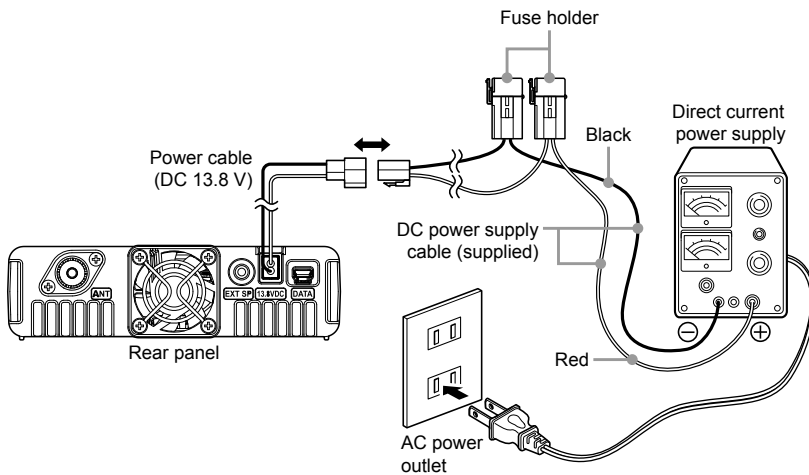

Front Panel Controls & Switches

Front Panel

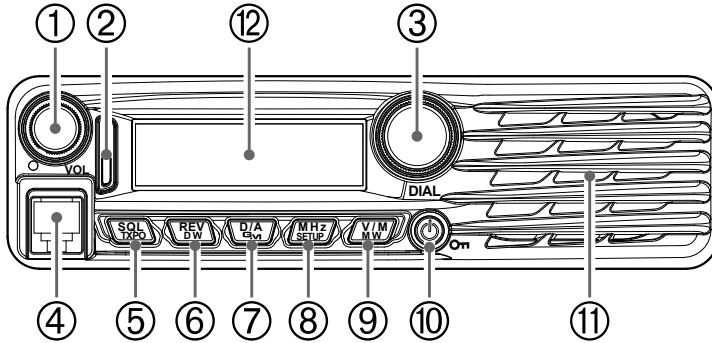

① VOL knob

Turning the knob clockwise increases the volume, whereas turning it counterclockwise decreases the volume.

② Mode/Status indicator

Indicates the transmission/reception status with a two-color combination on the upper and lower portions of the mode/status indicator.

Communication status	Upper portion	Lower portion
Receiving analog audio	Green	Green
Transmitting analog audio	Red	Red
Receiving digital audio	Green	Blue
Transmitting digital audio	Red	Blue
Receiving digital data	Green	White
Transmitting digital data	Red	White
Receiving signals with unmatched audio or data conditions*	Green	Blink in Blue

- * Receiving signals with unmatched tone frequency or DCS code.
- Receiving analog audio in digital mode.
- Receiving signals with unmatched SQL code in digital mode.
- Receiving a signal level less than the RF Squelch S-meter level setting.

③ DIAL Knob

- Allows setting the operating band frequency.
Turning clockwise increases the frequency, whereas turning counterclockwise decreases the frequency.
- Allows selecting the desired items for setup, memory registration, group monitoring operation, etc.

④ MIC Jack

Connect the provided microphone cable.

⑤ **[SQL(TXPO)]** key

Press and hold the key in for over one second to select the transmit power (HIGH: 55 W / MID: 25 W / LOW: 5 W).

⑥ **[REV(DW)]** key

During split-frequency operation, such as through a repeater, this key reverses the transmit and receive frequencies.

Press and hold the key in for over one second to activate the Dual Watch feature.

Note: For details, refer to the Advanced Manual (download from the Yaesu website).

⑦ **[D/A(GM)]** key

Briefly pressing each time switches the operating band communication mode.

Press and hold in this key for over one second to activate the GM (Group Monitor) function.

Note: For details on the GM function, see “GM (Group Monitor) Function” on 34

⑧ **[MHz(SETUP)]** key

This key allows tuning in 1 MHz steps (the MHz digits will blink on the display).

Press and hold this key in for over one second to activate the Setup (Menu) Mode.

⑨ **[V/M(MW)]** key

Pressing this key briefly, switches between VFO mode and memory mode. Press and hold the key for over one second to display the memory registration screen.

⑩ **Power/Lock** key

Press and hold in this key for over one second to switch the power between ON and OFF. Briefly pressing the key while the transceiver is turned ON engages or releases the key lock.

⑪ **Speaker**

The internal speaker is located here.

⑫ **LCD Display**

The main digits on the display may show the operating frequency, memory name, or any of many parameters during Menu setup.

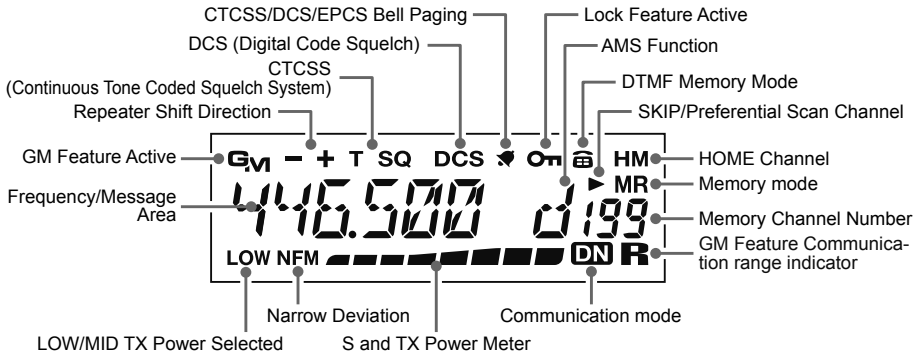

Microphone (MH-48A6JA)

① PTT Switch

Press this switch to transmit, and release it to receive.

② KEY Pad

These 16 keys generate DTMF tones during transmission.

In the receive mode, these 16 keys can be used for direct frequency entry and/or direct numeric recall of the Memory channels.

③ [P1] / [P2] keys

[P1] button

Press this button to recall the DG-ID memory.

[P2] button

Press and hold this button to enter the DGID memory screen.

[P3] / [P4] keys

These two keys are user programmable, allowing quick access to features used often. The default functions are described below.

[P3] button (Wires-X)

Press this button to activate the Wires-X feature.

[P4] button (TX PW/T.CALL)

In the USA version, pressing this button activates TX power setting.

In the EXP/European version, pressing this button activates T.CALL (1750 Hz) for repeater access.

You can reprogram the [P3], and [P4] buttons for other functions, if desired.

Note: For details, refer to the Advanced Manual (download from the Yaesu website).

④ MIC

Speak into this port during transmission.

⑤ [UP] / [DWN] keys

Press (or hold in) either of these buttons to tune (or scan up or down) the operating frequency or through the memory channels. In many ways, these buttons emulate the function of the (rotary) **DIAL** knob.

⑥ LOCK switch

This switch locks out the Microphone buttons (except for the keypad and **PTT** switch).

⑦ LAMP switch

This switch illuminates the Microphone keypad.

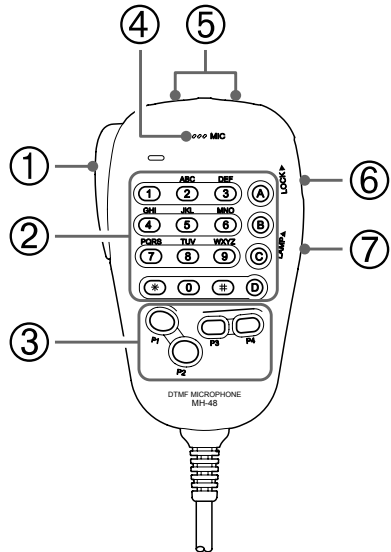

Rear Panel Connectors

Rear Panel

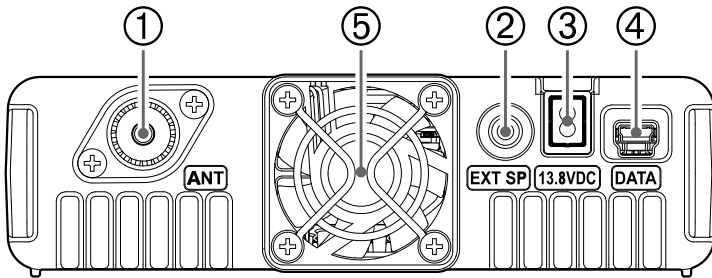

① ANT Coaxial Socket

Connect a 430 MHz antenna to this type-M (SO-239) socket using 50-Ohm coaxial cable and a type-M (PL-259) plug. Make sure the antenna is designed specifically for use on the operating frequency.

② EXT SP Jack

This 2-contact 3.5-mm mini phone jack provides receiver audio output for an optional external speaker. The audio impedance is 4 Ohms, and the level varies according to the setting of the front panel **VOL** control. Inserting a plug into this jack disables audio from the transceiver's internal speaker.

③ 13.8 V DC Cable

Connect the provided DC power supply cable (with fuse attached).

④ DATA Jack

Use this jack when updating the firmware. When a new firmware update for the FTM-3207DR/DE is available, go to the YAESU website to download the programming data and update the FTM-3207DR/DE to its newest state.

⑤ Cooling Fan

Basic Operation

Turning the Transceiver ON and OFF

1. To turn the transceiver ON, press and hold the **PWR/LOCK** key for one second.
2. To turn the transceiver OFF, again press and hold the **PWR/LOCK** key for one second.

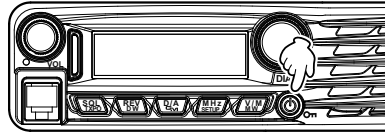

You can compose any desired Opening Message (up to 8 characters) via Setup Menu Item “**OPEN MSG 27**” see 43 for details.

Inputting the call sign

A screen requesting input of a call sign appears when turning the transceiver on for the first time, or after resetting the transceiver. The call sign is used to identify the transmitting station when communicating in digital mode.

1. Press the **[V/M(MW)]** key.
2. Rotate the **DIAL** knob to select characters, then press the **[V/M(MW)]**.

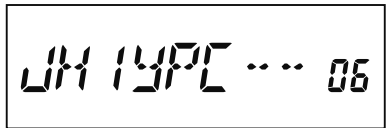

By rotating the **DIAL** knob, you can switch the characters in the following order:

“space” ⇨ “-” ⇨ “/” ⇨ “0” to “9” ⇨ “A” to “Z”

- Up to 10 characters (alphanumeric characters including hyphen) can be entered.
 - “space”, “-”, and “/” are not selectable for the first character.
3. Press and hold the **[MHz(SETUP)]** key for one second to save the call sign and exit to normal operation.

Adjusting the Audio Volume Level

Rotate the **VOL** knob to adjust the receiver volume. Clock-wise rotation increases the audio output level.

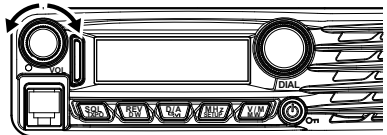

Adjusting the Squelch Setting

1. Press the **[SQL(TXPO)]** key, then rotate the **DIAL** knob to select the Squelch level.
2. Press the **[SQL(TXPO)]** key again.

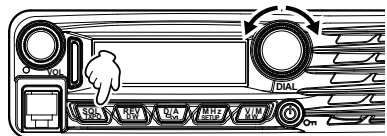

Note: A special “RF Squelch” feature is provided on this radio. This feature allows setting the squelch so that only signals exceeding a certain S-meter level will open the squelch. For details, refer to the Advanced Manual (download from the Yaesu website).

Frequency Navigation

Using the Dial

Rotating the **DIAL** knob allows tuning in the pre-programmed steps. Clockwise rotation tunes the frequency upwards, whereas counterclockwise rotation tunes the frequency downwards.

- Press the [**MHz(SETUP)**] key momentarily, then rotate the **DIAL** knob, to change the frequency steps to 1 MHz per step.

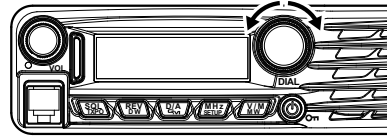

Using the MH-48A6JA Microphone

Using the [UP] and [DWN] key:

Pressing [**UP**] momentarily, tunes the frequency upwards. Whereas pressing [**DWN**] momentarily tunes the frequency in the downward direction.

Using the number keys:

Use the [0] to [9] number keys to directly input the frequency.

There is no “decimal point” key on the MH-48A6JA keypad. However, there is a short-cut for frequencies ending in zero: press the [#] key after the last non-zero digit.

- Examples:** To enter 446.520 MHz, press [4] ➡ [4] ➡ [6] ➡ [5] ➡ [2] ➡ [0]
 To enter 446.000 MHz, press [4] ➡ [4] ➡ [6] ➡ [#]

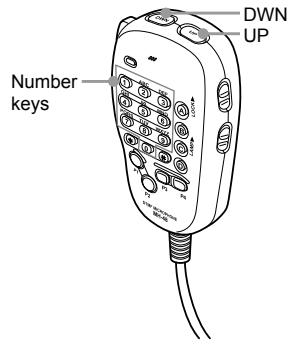

Channel Step Selection

The frequency tuning step of the **DIAL** and the microphone [**UP**]/[**DWN**] keys can be changed.

Note: See Setup Menu Item “**STEP 41**” on 44

Basic Operation

Selecting the communication mode

The FTM-3207DR/DE transceiver is equipped with the AMS (Automatic Mode Select) function which automatically selects from two modes of transmission corresponding to the signal being received.

The transmit mode is selected according to the received signal so that C4FM digital signals, and analog signals are received and transmitted automatically.

Press **[D/A(GM)]** key to display “**DN**” (blinks) icon on the screen.

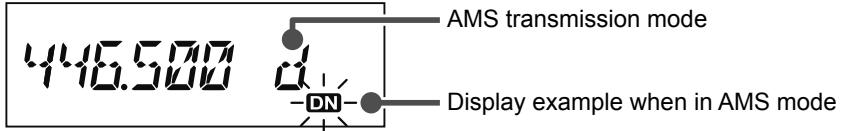

To operate in fixed communication mode, press **[D/A(GM)]** key to switch the communication mode.

Each time **[D/A(GM)]** key is pressed, the communication mode changes in the following order:

AMS (“**DN**” blinks) → V/D (“**DN**” lights up) → FM (no icon) →

Communication mode	Icon	Description of modes
AMS (Automatic Mode Select)	DN (blinks)	Transmit mode is automatically selected from 3 types according to the signal received. The AMS function operation can be changed from the Setup menu setting. See “Setting the transmit mode when using the AMS function (DIG AMS 12)” on 42
V/D Mode (Voice/Data simultaneous transmission mode)	DN (light up)	Calls are less prone to interruptions due to detection and correction of voice signals during digital voice signal transmission. This is the standard mode for C4FM Digital.
Analog FM Mode	no icon	Analog communication using FM mode. Effective when the signal is weak and audio is susceptible to interruption in digital mode.

Setting the transmission mode when using the AMS function

TXMANUAL (“DN” blinks: 1 sec on, 0.5 sec off)

Automatically selects one of the two communication modes according to the received signal. Briefly pressing [PTT] on the microphone switches between digital mode and analog mode.

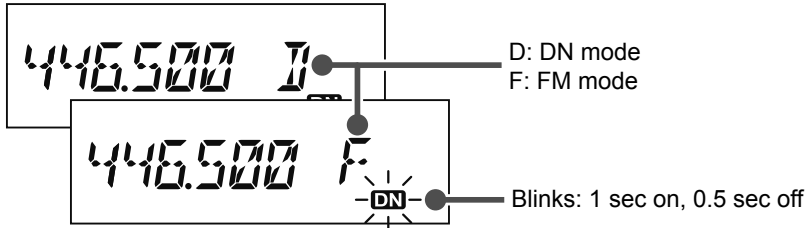

TX FMFIX (“DN” blinks: 0.5 sec on, 0.5 sec off)

Automatically selects one of the two communication modes according to the received signal. Always switches to FM mode for transmission.

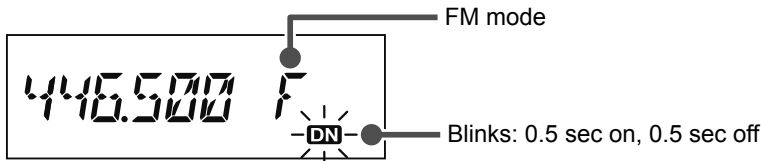

TX DNFIX (“DN” blinks: 0.5 sec on, 0.5 sec off)

Automatically selects one of the two communication modes according to the received signal. Always switches to DN mode for transmission.

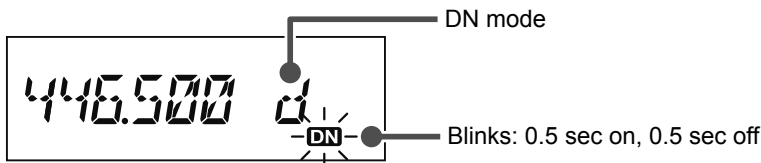

AUTO (“DN” blinks: 0.5 sec on, 0.5 sec off)

Automatically selects one of the two communication modes according to the received signal.

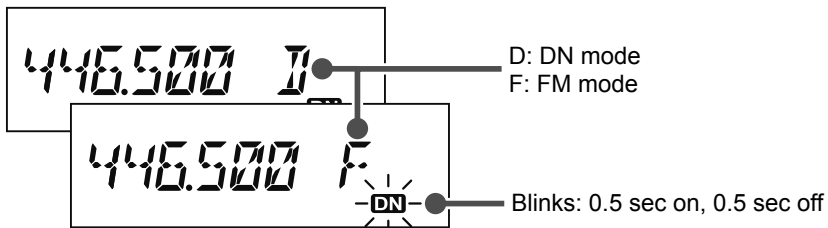

Basic Operation

Transmission

1. Press and hold **PTT** on the microphone.

In analog mode, both the upper and lower portions of the PTT mode/status indicator light red.

In digital mode, the upper portion of the mode/status indicator lights red and the lower portion of the mode/status indicator lights blue.

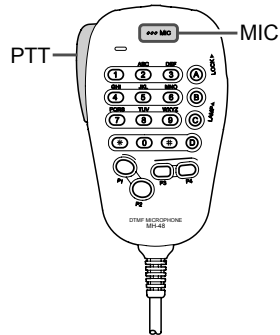

Analog mode: Both the upper and lower portions light red

Digital mode: The upper portion lights red and the lower portion lights blue

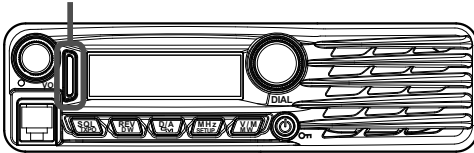

2. Speak into **MIC** on the microphone.

Note: Keep the microphone about 5 cm away from your mouth.

The sensitivity (gain) of the microphone can be adjusted. For details, refer to the Advanced Manual (download from the Yaesu website).

3. Release **PTT**.

The transmit mode/status indicator turns off and the transceiver returns to the receive mode.

Caution: Do not continue transmitting for a prolonged period. The transceiver may overheat, resulting in malfunction or injury.

Note: "ERROR" appears if you attempt to transmit on an unavailable frequency.

Adjusting the transmit power

When communicating with a nearby station, the transmit power level may be lowered to reduce the battery power consumption.

1. Press and hold the **[SQL(TXPO)]** key for over one second.
2. Rotate the **DIAL** to select the transmit power.

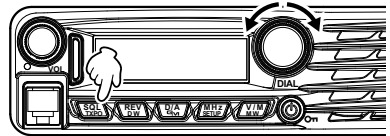

Note: The default setting: HIGH



HIGH (55 W)



MID (25 W)



LOW (5 W)

3. Press the **[SQL(TXPO)]** key to save the new setting and exit to normal operation.

Lock Feature

To activate the key-lock feature, press the **[Power(Lock)]** key. The "On" icon will appear on the LCD.

To cancel key-lock, press the **[Power(Lock)]** key again.

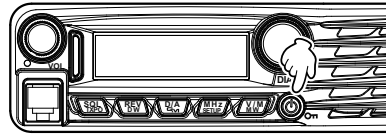

To select which keys are locked, use the Setup Menu Item "**LOCK 23**" see 43 for details.

About the Digital Group ID (DG-ID) feature

The DG-ID function can set up two-digit DG-ID numbers from “00” to “99” separately for Transmit and Receive. By setting both transmit and receive to “00” (default), you can communicate with all the other stations in the digital C4FM mode.

By matching the transmit DG-ID number to the uplink DG-ID number set in the club DR-2X/XE System Fusion II digital repeater, you can access the digital repeater DR-2X/XE used in the club.

For communication only among a group of friend’s transceivers, you can all match the same DG-ID number; then only your friend’s voices will be heard. Also, by using the GM function you can check whether stations with the same DG-ID are in the communication range. The FTM-3207DR/DE may register transmit and receive DG-ID numbers in the DG-ID memories (up to 10 pairs), and then use the [P1] / [P2] keys on the microphone to easily recall a Group ID.

Register the DG-ID number in the DG-ID memory

Example: Enter the transmit DG-ID number “50” and the receive DG-ID number “00” into the DG-ID memory “01”

1. Press and hold the [P2] key on the microphone.
The DG-ID memory number at the bottom right of the screen blinks.
2. Rotate the **DIAL** knob to select the DG-ID memory number to be stored to the “01” register.
3. Press the [P2] key on the microphone.
The transmit DG-ID number “T00” blinks.
4. Rotate the **DIAL** knob to set the transmit DG-ID number to “T50”.
5. Press the [P2] key on the microphone.
The transmit DG-ID number blinks.
6. Rotate the **DIAL** knob to set the receive DG-ID to “R00”.
7. Press the [P2] key on the microphone.
 - The input screen of the DG-ID tag is displayed.

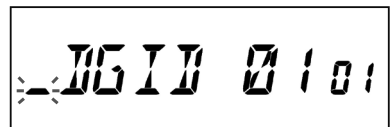
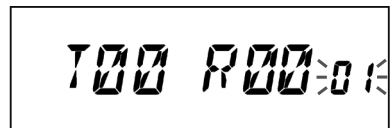

- Use the numeric keys on the microphone or the **DIAL** knob to input the characters of the DG-ID tag. Up to 8 characters can be entered.

Press the **[P3]** key on the microphone or **[SQL (TXPO)]** key to move the cursor to the left.

Press the **[P4]** key on the microphone or **[V/M (MW)]** key to move the cursor to the right.

8. Press and hold the **[P2]** key on the microphone to save the setting and return to normal operation.

Notes:

- The DG-ID memory “00” is fixed at “T00 R00” and cannot be changed.
- By pressing and holding the **[P2]** key on the microphone in the middle of the setting, the setting so far will write and then return to the normal screen.
- When the **[P2]** key on the microphone is not pressed while writing, after five seconds elapse the operation will return to the normal screen without saving the setting.

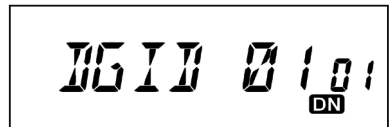

Recall and use the DG-ID number registered in the DG-ID memory

1. Press the **[P1]** key on the microphone, the information of the current DG-ID is displayed.
2. Rotate the **DIAL** knob to select the number of DG-ID List to recall.
3. Press the **PTT** button to select the DG-ID number and return to the frequency display screen. Or if five seconds passes, the selected screen will return to frequency screen automatically.
 - When using the DG-ID memory, the tag of the DG-ID memory being used is displayed every 5 seconds.
 - If the DG-ID memory is “00”, DG-ID memory tag is not displayed.

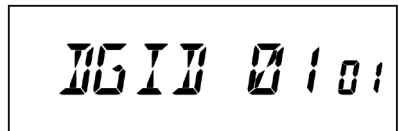

DG-ID Tag display

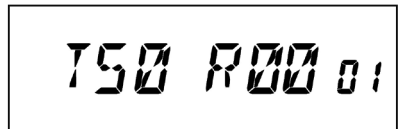

DG-ID Number display



Advanced Operation

- Press the **[P1]** key on the microphone to switch to the DG-ID number display as shown below. When the DG-ID memory is "00", no DG-ID tag is displayed, only the DG-ID number "00" is displayed.

DG-ID Tag display →

DG-ID Number display →

Normal Screen

- If there is no operation for more than five seconds, the display returns to the normal frequency display screen.



Normal Screen (Frequency)

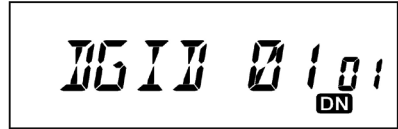

Normal Screen (DG-ID Tag)

Restore the DG-ID number to "00" for both transmit and receive without using the DG-ID memory

- Press and hold the **[P1]** key on the microphone while on the frequency display screen. The DG-ID memory returns to DG-ID memory "00" with one touch.

Use the GM (Group Monitor) with the DG-ID function

- Press and hold the **[D/A(GM)]** key to turn the GM (Group Monitor) function ON, then you can check whether or not other Group Member stations are operating within communications range.



- The "GM" icon is displayed at the upper left of the display.
- The other stations also need to turn the GM function ON.
- While operating in the GM function, the call sign of a maximum 24 stations turned the GM function ON, and that are within the communication range, may be checked.
- Rotate the **DIAL** knob to select the other stations.

- Press and hold the **[D/A(GM)]** key to turn the GM (Group Monitor) function OFF.

Notes:

- The DG-ID memory "00" is fixed at "T00 R00" and can not be changed.
- If the DG-ID memory is "00", DG-ID memory tag is not displayed every 5 seconds.
- If the receive DG-ID number is set to other than "00", note that you cannot receive signals other than the same DG-ID number.

Digital Personal ID (DP-ID) feature

Every C4FM digital transmit communication contains the individual ID information (Radio ID) of each transceiver. The DP-ID function uses this individual ID information.

When communicating with another transceiver, if the DP-ID of the stations are registered in each other's transceivers, they can communicate even if the DG-ID numbers are different.

Registering the DP-ID to a DR-2X digital repeater

Note: To register the transceiver DP-ID in the System Fusion II, DR-2X C4FM digital repeater, refer to the instruction manual of the DR-2X.

By registering the transceiver's DP-ID in the DR-2X, you can remotely control the settings and functions of DR-2X. Remote control cannot be performed from a transceiver that does not register the DP-ID, so it is possible to securely manage repeaters.

DR-2X Remote Control Feature

- Activate the repeater operation
- Deactivate the repeater operation
- Set the repeater to C4FM mode
- Set the transmit power
- Voice Message Control (Rec / Play / Stop)
- Set the Emergency Call

Register the transceivers

1. Press and hold the [MHz(SETUP)] key to enter the Setup Menu.
2. Rotate **DIAL** knob to select "DPID LST 14".
3. Press the [MHz(SETUP)] key.

The DP-ID List is displayed.



4. While the DP-ID list is displayed, a transmission in the digital C4FM mode from the other transceiver will register the DP-ID.

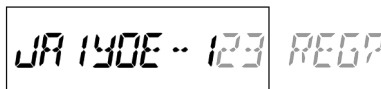

When a signal from the other station is received, the call sign is displayed on the LCD.

Notes:

- When a signal from the already registered transceiver is received, the display of DP-ID list does not change.
- When registering a transceiver already registered with a different call sign, the call sign registered in the DP-ID list is changed to registrar the new call sign.

Advanced Operation

- Press and hold the **[D/A(GM)]** key to save the setting.
 - When registering in the DP-ID list is finished, "Completed" is displayed, then the display returns to the DP-ID list screen.
 - To continue operating without registering the DP-ID, press the **[D/A(GM)]** key.
 - If registering several DP-IDs, repeat steps 4 to 5.
 - A maximum of 24 stations may be registered.
- Press and hold the **[MHz(SETUP)]** key to return to normal operation.
Register the DP-ID of all the transceivers in the group to another transceiver using the same operation.

Notes:

- Once the DP-ID is registered, the DP-ID is stored until the DG-ID is deleted.
- Register with the another transceiver while each other's transceivers are nearby.

Deleting the registered DP-ID

- Press and hold the **[MHz(SETUP)]** key to enter the Setup Menu.
- Rotate **DIAL** knob to select "**DPID LST 14**".
- Press the **[MHz(SETUP)]** key.
The DP-ID List is displayed.

The LCD display shows the call sign "JA 140E" followed by a dash and the number "1", with another "1" on the right side of the display.

- Rotate the **DIAL** knob to select the call sign.
- Press and hold the **[D/A(GM)]** key
The confirmation screen is displayed.

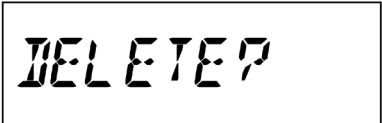
The LCD display shows the word "DELETE?" in a large, blocky font.

- Press and hold the **[D/A(GM)]** key again to delete.
 - When deleting in the DP-ID list is finished, "COMPLETE" is displayed for three seconds, then the display returns to the DP-ID list screen.
 - To return to normal operation without deleting the DP-ID, press the **[D/A(GM)]** key.
 - If deleting several DP-IDs, repeat steps 4 to 6.
- Press and hold the **[MHz(SETUP)]** key to return to normal operation.

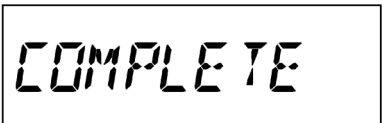
The LCD display shows the word "COMPLETE" in a large, blocky font.The LCD display shows the call sign "JA 140E" followed by a dash and the number "1", with another "1" on the right side of the display.

Repeater Operation

The FTM-3207DR/DE includes the ARS (Automatic Repeater Shift) function, which permits communication through repeaters automatically, by simply setting the receiver to the repeater frequency.

1. Tune to the repeater frequency.
2. Press the **PTT** to transmit.

During transmission, radio waves having an 100.0 Hz* tone signal are emitted on the frequency offset from the receive frequency by 5.0 MHz*.

*: Depends on the transceiver version.

Note: From the Setup Menu, you can change the repeater setting.

RPT ARS 34 ➡ Deactivates the ARS function.

RPT FREQ 35 ➡ Allows changing the repeater shift frequency offset.

RPT SFT 36 ➡ Allows setting the repeater shift direction.

Checking the Repeater Uplink (Input) Frequency

It is often helpful to be able to check the uplink (input) frequency of a repeater, to see if the calling station is within direct (“Simplex”) range.

To do this, just press the **[REV(DW)]** key. You’ll notice that the display has shifted to the repeater uplink frequency. Press the **[REV(DW)]** key again to cause operation to revert to normal monitoring of the repeater downlink (output) frequency. While listening on the repeater input frequency using the **[REV(DW)]** key, the repeater offset icon will blink.

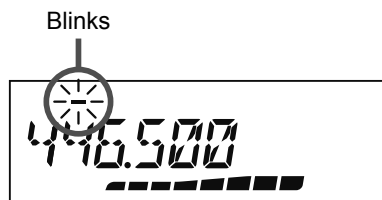

Tone Calling (1750 Hz)

If your transceiver is FTM-3207DE (European version), press and hold in the program key **[P4]** of the microphone (MH-48) to generate a 1750 Hz burst tone to access the European repeater. The transmitter will automatically be activated, and a 1750 Hz audio tone will be superimposed on the carrier. Once access to the repeater has been gained, you may release the **[P4]** key, and use the **PTT** for activating the transmitter thereafter.

Advanced Operation

CTCSS Operation

This radio is equipped with the CTCSS (Continuous Tone-coded Squelch System) that allows audio to be heard only when receiving signals containing a tone corresponding to the tone squelch menu setting. By matching the CTCSS tone with the partner station in advance, quiet standby monitoring is possible.

Caution: CTCSS does not function in digital mode. To transmit a signal using a CTCSS code, use the [D/A(GM)] key to switch the communication mode to AMS (Auto Mode Select function) or analog (FM) mode.

1. Press and hold the [MHz(SETUP)] key for over one second.
The Setup menu appears.
2. Rotate the **DIAL** knob to select “SQL TYPE 40”, then press the [MHz(SETUP)] key.
3. Rotate the **DIAL** knob to select “TSQL”, then press and hold the [MHz(SETUP)] key for over one second.

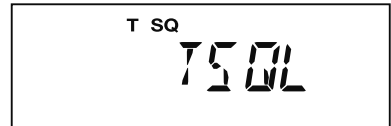

“T SQ” is displayed on the screen. Now the squelch opens only when receiving tone signals of the set frequency.

Note: From the Setup Menu, you can change the CTCSS setting.

tone FRQ 43 ▶▶ The tone frequency can be selected from 50 frequencies.

BELL 7 ▶▶ A bell tone (beep) may be set to sound when signals containing a corresponding CTCSS tone are received.

Tone Search

When the CTCSS tone being transmitted by another station is not known, you can tune the radio to the incoming signal and activate tone scan to search for and identify the tone being used.

Note: For details, refer to the Advanced Manual (download from the Yaesu website).

DCS Operation

This radio is equipped with a DCS (Digital Coded Squelch) function that allows audio to be heard only when signals containing the corresponding DCS code are received. By matching the DCS code with the partner stations beforehand, a quiet receive standby is possible.

Caution: DCS does not function in digital mode. To transmit a signal with a DCS code, use the [D/A(GM)] key to switch the communication mode to AMS (Auto Mode Select function) or analog (FM) mode.

1. Press and hold the [MHz(SETUP)] key for over one second.
The Setup menu appears.
2. Rotate the **DIAL** knob to select “SQL TYPE 40”, then press the [MHz(SETUP)] key.

3. Rotate the **DIAL** knob to select “**DCS**”, then press and hold the [**MHz(SETUP)**] key for over one second.



Displays “**DCS**” on the screen. The squelch opens only when receiving a signal containing the corresponding DCS code.

Note: From the Setup Menu, you can change the DCS setting.

DCS CODE 10 ▶ The DCS code can be selected from 104 codes.

BELL 7 ▶ A bell tone (beep) may be set to sound when signals containing a corresponding DCS code are received.

DCS Search

When the DCS code being transmitted by another station is not known, you can tune the radio to the incoming signal and activate DCS code scan to search for and identify the DCS code being used.

Note: For details, refer to the Advanced Manual (download from the Yaesu website).

The following features are also available:

EPCS (Enhanced Paging & Code Squelch) Operation

Use the pager code consisting of two CTCSS tones to exchange communications with specified stations.

Note: For details, refer to the Advanced Manual (download from the Yaesu website).

Split Tone Operation

The FTM-3207DR/DE can be operated in a “Split Tone” configuration that enables operation on repeaters using a mix of both CTCSS and DCS control via the Setup menu.

Note: For details, refer to the Advanced Manual (download from the Yaesu website).

DTMF Operation

DTMF tones (Dual Tone Multi Frequencies) are the tones you hear when dialing from a telephone keypad. The FTM-3207DR/DE transceiver can transmit the DTMF codes by using the keys on the microphone or recalling registered number strings from memories. The maximum of 16-digit DTMF codes can be registered in up to 10 memory channels. It is convenient to register telephone patch numbers, and network linking sequences to the DTMF memory channels.

Note: For details, refer to the Advanced Manual (download from the Yaesu website).

Memory Operation

The FTM-3207DR/DE provides a wide variety of memory system resources. These include:

- ❑ 199 “basic” memory channels, numbered “1” through “199”.
- ❑ A “Home” channel, providing storage and quick recall of one prime frequency.
- ❑ 10 sets of band-edge memories, also known as “Programmable Memory Scan” channels, labeled “L0/U0” through “L9/U9”.

Each memory may be appended with an alphanumeric label of up to 8 characters, for quick channel recognition.

Memory Storage

1. In the VFO mode, select the desired frequency, repeater shift, CTCSS/DCS tone, and TX power level.
2. Press and hold the [V/M(MW)] key for one second.

A memory number will appear in the bottom right corner of the display.

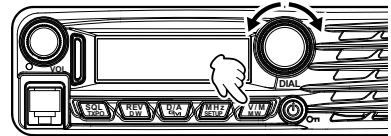

Note: If the channel number is blinking, there currently is no data stored on that channel; if the channel number is not blinking, that channel is currently “occupied” by other frequency data.



3. Within five seconds of pressing the [V/M(MW)] key, use the **DIAL** knob to select the desired memory into which you wish to store the frequency.

Note: While operating in the Memory Storage mode, the keypad of the MH-48A6JA Microphone may be used to enter the memory channel number directly.

To do this, enter the desired Channel Number on the keypad and then press the [#] key. Refer to the “For example” of the “Memory Recall from the Microphone Keypad” on next page.

4. Press the [V/M(MW)] key again, this time momentarily, to store the displayed data into the selected memory channel slot.
5. To store additional frequencies, repeat steps 1 through 4, remembering to set the repeater shift, CTCSS/DCS tone, and TX power level, as appropriate.

Split Memory

A separate transmit frequency may be registered to a memory channel to which a receive frequency has already been registered.

Note: For details, refer to the Advanced Manual (download from the Yaesu website).

Naming a Memory Channel

You may also append an alphanumeric “Tag” (label) to each memory, to aid in recollection of the channel’s use (such as club name, etc.).

Note: For details, refer to the Advanced Manual (download from the Yaesu website).

Memory Recall

Once the desired frequencies are stored into memory channels, switch from the “VFO” mode to the “Memory Recall” mode, to operate on the just-stored memory channels.

1. Press the [V/M(MW)] key, repeatedly if necessary, until the “MR” icon and a memory channel number appear on the display; this indicates that the “Memory Recall” mode is now engaged.
2. When more than one memory has been stored, use the **DIAL** knob to select any of the programmed memories for operation.

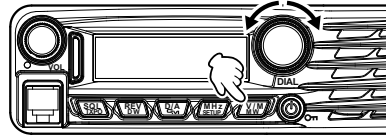

Note: Alternatively, the microphone [UP] or [DWN] button may be used to step or scan through the available memories. When using the microphone buttons, press the button momentarily to move one step up or down; press and hold the [UP] or [DWN] button for one second to begin memory scanning.

Memory Recall from the Microphone Keypad

While operating in the Memory Recall mode, the keypad of the MH-48A6JA Microphone may be used for direct recall of memory channels.

To do this, enter the desired Channel Number on the keypad and then press the [#] key.

For example:

To recall Memory Channel “5”, press [5] ➡ [#]

To recall Memory Channel “123”, press [1] ➡ [2] ➡ [3] ➡ [#]

You may also recall Programmable Memory Scan (PMS) channels (“L0/U0” through “L9/U9”) by entering the channel numbers listed in the below table:

L1	201	L3	205	L5	209	L7	213	L9	217
U1	202	U3	206	U5	210	U7	214	U9	218
L2	203	L4	207	L6	211	L8	215	L0	219
U2	204	U4	208	U6	212	U8	216	U0	220

Moving Memory Data to the VFO

Data stored on memory channels can easily be moved to the VFO.

Note: For details, refer to the Advanced Manual (download from the Yaesu website).

Memory Only Mode

Once memory channel programming has been completed, you may place the radio in a “Memory Only” mode, whereby VFO operation is impossible.

Note: For details, refer to the Advanced Manual (download from the Yaesu website).

Memory Operation

Masking Memories

There may be situations where you want to “Mask” memories so they are not visible during memory selection or scanning. (except for Memory Channel “1”, the Priority Channel, and the Home Channel).

1. In the Memory Recall mode, press and hold the [V/M(MW)] key for one second, then rotate the **DIAL** knob to select the memory channel you wish to mask.
2. Press the [SQL(TXPO)] key.
The erase confirmation screen appears.
3. Press the [SQL(TXPO)] key.
The previously selected memory will be “masked”.

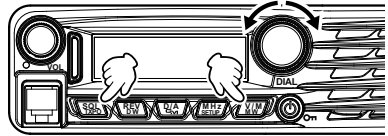

Note: Press any key, other than [SQL(TXPO)], to cancel the memory mask.

Unmasking Memories

1. To Unmask a hidden memory, in the Memory Recall mode, press and hold the [V/M(MW)] key for one second.
2. Rotate the **DIAL** knob to select the masked memory number.
3. Press the [SQL(TXPO)] key to restore the memory channel data.

HOME Channel Memory

A convenient one-touch “Home” channel memory is available to simplify returning to an often used frequency.

To recall the Home channel, just press the [V/M(MW)] key, repeatedly if necessary, until the “**HM**” icon appears on the display; this indicates that the Home Channel has been recalled.

Note: When shipped from the factory, the Home Channel is set to 446.000 MHz (USA version) or 433.000 MHz (EXP/ European version).

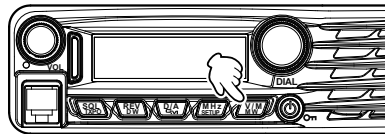

Changing the frequency of the home channel

The default frequency setting of the home channel can be changed.

1. In the VFO mode, tune to the desired Home channel frequency.
2. Press and hold the [V/M(MW)] key for one second, and then press the [REV(DW)] key.
The overwrite confirmation screen appears.
3. Press the [REV(DW)] key.
The home channel frequency is overwritten.

Basic Scanner Operation

Before activating the scanner, make sure that the Squelch is set to silence the background noise when no signal is present. Scanning is not possible while the Squelch is open (if noise or signals are being heard).

Scanning may be started or stopped using the microphone [UP] or [DWN] button.

The following techniques are used for scanning:

- in the **VFO mode**, press and hold either the [UP] or [DWN] button for one second, to start upward or downward scanning of the band.
- In the **Memory mode**, press and hold either the [UP] or [DWN] button for one second to start channel scanning toward a higher or lower-numbered memory channel, respectively.

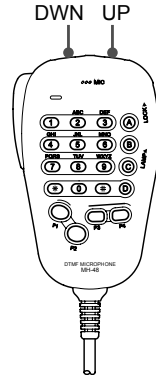

- Scanning pauses when a signal opens the squelch, and the decimal point on the display will blink. You can choose one of three scan-resume modes (described later).
- To halt the scan manually, the easiest way is to push the **PTT** switch on the microphone momentarily (no transmission will occur while you are scanning). The scan may also be halted manually by pressing the microphone [UP] or [DWN] button, or the [V/M(MW)] key.

Scan Resume Options

Select which of the three resume scan modes is to be performed after the scanning stops.

Note: For details, refer to the Advanced Manual (download from the Yaesu website).

Memory Skip Scanning

Memory channels which you do not want to receive can be skipped during scanning.

Note: For details, refer to the Advanced Manual (download from the Yaesu website).

Preferential Memory Scan

Set up a “Preferential Scan List” of channels which you can “flag” within the memory system.

Note: For details, refer to the Advanced Manual (download from the Yaesu website).

Programmable Memory Scan (PMS)

Using the dedicated PMS memory channels, only the frequencies within the specified frequency range will be scanned.

Note: For details, refer to the Advanced Manual (download from the Yaesu website).

Priority Channel Scanning (Dual Watch)

Scanning features include a two-channel scanning capability which allows you to operate on a VFO, Memory channel, or Home channel, while periodically checking a user defined Memory Channel for activity.

Note: For details, refer to the Advanced Manual (download from the Yaesu website).

What is the GM (Group Monitor) Function?

The GM function automatically monitors the channel for any other stations with the GM function in operation on the same frequency, or stations transmitting in DN mode that are within communication range. You can be notified of GM stations operating within communications range, and the detected call signs are displayed on the transceiver screen.

Caution: The GM function does not work while in the analog (FM) mode.

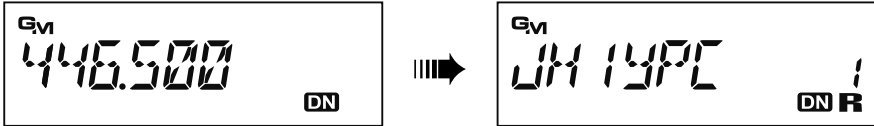

Displaying all the stations using the GM function

1. Tune to the designated frequency.
2. Press and hold the **[D/A(GM)]** key for one second.

The GM function is activated, and up to 24 stations using the GM mode, or stations operating in DN mode on the channel frequency, within the communication range are displayed

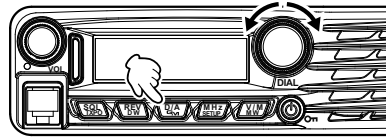

- Displays “**R**” for stations within your communication range.
 - Displays “**R**” (blinks) for stations outside of your communication range.
 - Turn the **DIAL** knob to select a station and display its communication range information.
3. Press and hold the **[D/A(GM)]** key for one second to disable the GM function and return to the frequency screen.

Reset Procedure

In some instances of erratic or unpredictable operation, the cause may be corruption of data in the microprocessor (due to static electricity, etc.). If this happens, resetting the microprocessor may restore normal operation. Note that all memories will be erased if you do a complete microprocessor reset, as described below.

Microprocessor Resetting

To clear all memories and other settings to factory defaults:

1. Turn the radio OFF.
2. Press and hold the [D/A(GM)], [MHz(SETUP)], and [V/M(MW)] keys while turning the radio on. The “ALL RESET PUSH V/M KEY” notation will scroll on the display.



ALL RESET PUSH V/M KEY

3. Press the [V/M(MW)] key momentarily to reset all settings to their factory defaults (press any other key to cancel the Reset procedure).

Setup (Menu) Mode Resetting

To reset the Setup (Menu) Mode settings to their factory defaults, while leaving other settings unchanged:

1. Turn the radio OFF.
2. Press and hold the [D/A(GM)] and [MHz(SETUP)] keys while turning the radio on. The “SET MODE RESET PUSH V/M KEY” notation will scroll on the display.



SET MODE RESET PUSH V/M KEY

3. Press the [V/M(MW)] key momentarily to reset the Setup (Menu) Mode settings to their factory defaults (press any other key to cancel the Reset procedure).

Clone

The FTM-3207DR/DE includes a convenient “Clone” feature, which allows the memory and configuration data from one transceiver to be transferred to another FTM-3207DR/DE.

This can be particularly useful when configuring a number of transceivers for a public service operation.

Note: For details, refer to the Advanced Manual (download from the Yaesu website).

Connecting the WIRES-X feature

What is WIRES-X?

WIRES-X is an Internet communication system which expands the range of amateur radio communication. You may employ Internet communications by connecting from your transceiver to a WIRES-X local node station.

***FTM-3207DR/DE** does not accommodate the transmission/reception of messages, images, audio messages, or location information.

Connecting to a WIRES-X digital node (Recommended)

*Ascertain the DSQ code or the DG-ID setting of the WIRES-X node station. Connecting to the WIRES-X node requires the transceiver DG-ID be set according to the DSQ code or the DG-ID code set on the WIRES-X node station.

*Confirm that the operating mode of WIRES-X node has been set to the C4FM digital mode.

1. Set the transmit/receive DG-ID to the same ID number as the node station.

For more details on the DG-ID number, see page 22

2. Transmit on the corresponding transmit/receive frequency.

- If the signal is received from the node, continue to transmit using the DGID setting as is.
- If the signal is not received from the node, ► proceed to “Connecting to the other node ID or the other room ID”

Connecting to the other node ID or the other room ID

1. Press and hold the [**MHz(SETUP)**] key to enter the Setup Menu.
2. Rotate the **DIAL** knob to select “**W-DGID 49**”, then press the [**MHz(SETUP)**] key.
3. Rotate the **DIAL** knob to set the WIRES-X DG-ID to the same ID number as the node station.

Display	Description
DGID01-99	Only nodes matching the set DG-ID number may be connected.
AUTO (default setting)	Only open nodes, set to the DG-ID number "00" may be connected.

4. Press the **PTT** switch, or press and hold the [**MHz(SETUP)**] key to save the new setting and return to normal operation.
5. Press the [**P3**] key.
“WIRES” blinks.



Connecting the WIRES-X feature

After successfully connecting to the node, one of the following screens is displayed indicating the node status.

1. Node ID screen (the Node Lc screen)

- This screen is displayed if the node is disconnected from the other node or the room on the Internet.
- The node station's node ID is displayed.
- Continue to select a connecting node ➡ proceed to step 6



2. Connecting to a node ID or room ID screen (the Cn screen)

- This screen is displayed when the node has been connected to a node or room on the Internet.
- The connecting node station's node ID is displayed.
- If not changing the connecting node/room ➡ proceed to step 7
- When changing the connecting node/room ➡ proceed to step 6



Note: If the node connection is not successful, the beep sound is emitted and the transceiver returns to the normal operation.

6. Rotate the **DIAL** knob to select one of the connection screens (see below information), and connect to the desired node/room.

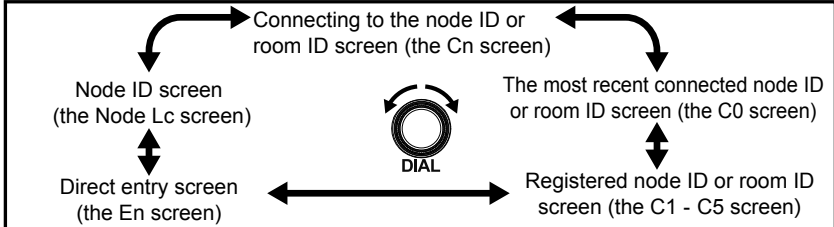

The most recent connected node ID or room ID screen (the C0 screen)

Most recent connected node ID or room ID is displayed. A single press of the [#] key on this screen will connect to the most recent node/room.

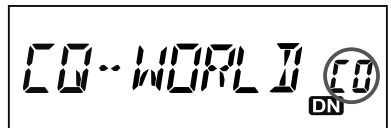

Registered node ID or room ID screen (the C1-C5 screen)

Rotate the **DIAL** knob to select a previously registered node/room (maximum 5 nodes/rooms) on the C1-C5 screen and, then press the [#] key or the **PTT** switch to connect to the node/room.

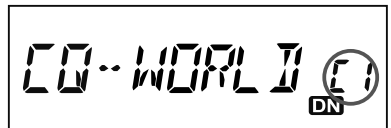

Connecting the WIRES-X feature

- **Registering the node/room:** Press and hold the [1]-[5] key to register the node/room (C1-C5) on the connected node ID or room ID (Cn).
- **Cancelling the connected node/room:** Select the node/room (C1-C5) then press and hold the [C] key to delete the registered node/room.

☐ Direct entry screen (En)

Direct connection to a node or room may be made by inputting the other node ID or room ID (5 digits) manually.



- Pressing the numeric keys (5 digits), and then press the [#] key, will request connection with another node ID or room ID.
- **Clearing the input node ID or room ID:** Press and hold the [C] key
- **Cancelling the input node ID or room ID:** Pressing the [*] key to return to the node ID screen (Lc) or the connecting node ID or room ID screen.

Note: When a node has been connected, the node or room connection may be changed by inputting a different node ID or room ID.

When connecting to a node or room, "CONNECT" is displayed on the screen, and the display is automatically switched to the connecting node ID or room ID screen (Cn).



Note: In the case when the selected node or room is not connected, the screen will display one of the below icons.

"OFFLINE" (Node or room is not in operation.)

"BUSY" (Another node is connecting.)

7. Transmit to communicate with the WIRES-X Internet Link.

Note: Operations of the microphone [#], PTT, [*], and [D] keys, are described in the below chart:

Operation method (operation screen)	Description
Press the [#] key or the PTT switch (C0 / C1 to C5 / En screen*)	Connect to the displayed node/room or change the destination connection. (*The PTT switch is disabled on the En screen)
Press and hold the [*] key (Lc / Cn / C0 / C1 to C5 / En screen)	Disconnect from the connected node or room.
Press and hold the [1] to [5] key (Cn screen)	The connected node or room ID is registered to the memory of the number when it is pressed and held (In case the memory is already written, the registration is overwritten).

Connecting the WIRES-X feature

Press the [D] key
(On activating WIRES-X)

Temporarily displays the operating frequency (when calling C4FM digital signal, the callsign of the other station is displayed). Press the [D] key again to return to the previous screen.

8. When communication is completed, press and hold the microphone [P3] key to Exit WIRES-X mode.

Note: About WIRES-X open node stations

A listing of the WIRES-X open node stations, with their location, operation mode, etc. is posted on the Yaesu WIRES-X website.

<https://www.yaesu.com/jp/en/wires-x/index.php>

Connect and communicate with WIRES-X in analog mode

In analog mode, specify the connection destination using DTMF signals.

1. In the normal operating screen, press the [D/A(GM)] key to set the analog FM mode, and then tune to the frequency of the node station.

Note: When DTMF function is set to "AUTO" (DTMF Icon displayed on the LCD), change to "MANUAL" using the following steps.

Press and hold the [MHz(SETUP)] key \blacktriangleright Rotate the **DIAL** knob to select "DT AUTO 15" \blacktriangleright Press the [MHz(SETUP)] key \blacktriangleright Rotate the **DIAL** knob to select "MANUAL" \blacktriangleright Press and hold the [MHz(SETUP)] key

2. While holding down the **PTT** switch on the microphone, press the [#] key and then enter the 5 digit ID number of the node or room to be connected, the DTMF code will be sent to the node station.

3. Keep the transceiver in receive mode for about 10 seconds. Once connection is established, you will be able to hear audio.

Note: The connected destination screen will not appear.

4. Face the microphone and speak.

Disconnecting from the node or room

1. While pressing the **PTT** switch, then enter the "#99999" (DTMF disconnect command) keys.

Note: In analog mode, the excellent C4FM features such as clear voice, digital information etc cannot be used, so we recommend using digital C4FM when communicating with the WIRES-X Internet Linking System

Miscellaneous Settings

Programming the Key Assignments

Default FTM-3207DR/DE key functions have been assigned to the Microphone's [P3]/[P4] keys at the factory. The user may change these key function assignments, if quick access to another function is desired.

Note: For details, refer to the Advanced Manual (download from the Yaesu website).

Keyboard Beeper

A key/button beeper provides useful audible feedback whenever a key/button is pressed. If you want to turn the beeper off (or back on again).

Note: If you want to turn the beeper off (or back on again), see Setup Menu Item “**BEP KEY 3**” on 42.

Display Brightness

You can adjust the display brightness.

Note: See Setup Menu Item “**LCD DMMR 22**” on 43.

Time-Out-Timer (TOT)

The “Time-Out Timer” (TOT) feature is designed to force the transceiver into the “receive” mode after a preset time period of continuous transmission (the default is 3 minutes).

Note: See Setup Menu Item “**TOT 44**” on 44.

Automatic Power Off (APO)

The “Automatic Power-Off” (APO) feature will turn the radio completely off after a user defined period of PTT or key/button inactivity.

Note: See Setup Menu Item “**APO 1**” on 42.

Busy Channel Lock-Out (BCLO)

The BCLO feature prevents the transmitter from being activated whenever a signal strong enough to break through the “noise” squelch is present on the frequency.

Note: See Setup Menu Item “**BCLO 2**” on 42.

TX Deviation Level

You can reduce the receiver bandwidth and transmit deviation when operating on closely spaced frequencies (channel spacing of 12.5 or 15 kHz). The reduced transmitter deviation will minimize adjacent channel interference to other users.

Note: See Setup Menu Item “**W/N DEV 48**” on 44.

MIC Gain Setting

At the factory, the microphone gain has been programmed so that it should be satisfactory for the supplied MH-48A6JA Microphone. If you use an after-market microphone or connect a TNC, you may wish to set a different Mic Gain level.

Note: See Setup Menu Item “**MIC GAIN 24**” on 43.

Displaying the Supply Voltage

Display the Power Supply voltage.

Note: See Setup Menu Item “**DC VOLT 9**” on 42.

Displaying the Temperature

Indicates the current temperature inside the transceiver’s case.

Note: See Setup Menu Item “**TEMP 42**” on 44.

Band Edge Beeper

The FTM-3207DR/DE will automatically “beep” when the receiver’s band edge is encountered during scanning (either in standard VFO scanning or during PMS operation). You may additionally enable this feature (band edge beeper) when the frequency reaches the band edge while selecting the VFO frequency manually, using the **DIAL** knob.

Note: For details, refer to the Advanced Manual (download from the Yaesu website).

Setup (Menu) Mode

The FTM-3207DR/DE Setup (Menu) mode, already described in parts of many previous chapters, is easy to activate and setup. The Menus may be used to configure many of transceiver parameters, some of which have not been detailed previously. Use the following procedure to activate the Setup (Menu) mode:

1. Press and hold the **[MHz(SETUP)]** key for one second to enter the Setup menu.
2. Rotate the **DIAL** knob to select the Menu Item to be adjusted.
3. Press the **[MHz(SETUP)]** key momentarily to enable adjustment of the selected Menu item, and then rotate the **DIAL** knob to perform the actual adjustment.
4. After completing the selection and adjustment, press and hold the **[MHz(SETUP)]** key for one second to exit the Setup menu and resume normal operation.

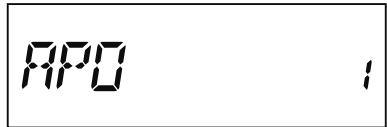
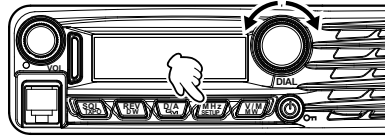

Note: For details, refer to the Advanced Manual (download from the Yaesu website).

Menu Item	Function	Available Values	Default
1: APO	Enables/Disables the Automatic Power Off feature.	0.5H to 12H (0.5H step)/OFF	OFF
2: BCLO	Enables/Disables the Busy Channel Lock-Out feature.	ON/OFF	OFF
3: BEP KEY	Enables/Disables the key beeper.	KEY+SCAN/KEY/OFF	KEY+SCAN
4: BEP EDGE	Enables/Disable the Band-edge beeper while scanning.	ON/OFF	OFF
5: BEP LVL	Sets the beep level	High/Low	High
6: BEP STBY	Enables/Disable the Standby beep	ON/OFF	ON
7: BELL	Selects the CTCSS/DCS/EPCS Bell Ringer repetitions.	1 to 20/CONTINUE/OFF	OFF
8: CLK TYPE	Shifting of the CPU clock frequency.	A/B	A
9: DC VOLT	Indicates the DC Supply Voltage.	---	---
10: DCS CODE	Setting of the DCS code.	104 standard DCS codes	023
11: DCS INV	Select a combination of DCS inversion codes in terms of communication direction.	NORMAL / INVERT / BOTH	NORMAL
12: DIG AMS	Sets the transmission mode	TXMANUAL/TX FMFIX/TX DNFIX/AUTO	TXMANUAL
13: DI POPUP	Sets the information pop-up time	2/4/6/8/10/20/30/60/CONTINUE/OFF	10 SEC
14: DPID LST	DP-ID list (Display/Register/Clear)	(Registered DP-ID)	---
15: DT AUTO	Enables/Disables the DTMF Autodialer feature.	MANUAL/AUTO	MANUAL

Setup (Menu) Mode

Menu Item	Function	Available Values	Default
16: DT DELAY	Setting of the DTMF Autodialer TX Delay Time.	50/250/450/750/1000	450 MS
17: DT SET	Loading of the DTMF Autodialer Memories.	---	---
18: DT SPEED	Setting of the DTMF Autodialer Sending Speed.	50/100	50 MS
19: DW RVRT	Enables/Disables the "Priority Channel Revert" feature.	ON/OFF	OFF
20: GM RINGR	Enables/Disables the alert sound when detecting stations within communication range	IN RANGE/ALWAYS/OFF	IN RANGE
21: GM INTVL	Selects the automatic sending interval.	NORMAL/LONG	NORMAL
22: LCD DMMR	Setting of the front panel display illumination level.	LEVEL 1/2/3/4	LEVEL 4
23: LOCK	Selects the Control Locking Lockout combination.	KEY + D I A L / P T T / KEY+PTT/DIAL+PTT/ ALL/KEY/DIAL	KEY+DIAL
24: MIC GAIN	Adjust the microphone gain level.	LEVEL 1 to 9	LEVEL 5
25: MEM NAME	Programming an Alpha/Numeric label for a Memory Channel.	---	---
26: MW MODE	Selects the method of selecting of channels for Memory Storage.	NEXT CH/LOWER CH	NEXT CH
27: OPEN MSG	Selects the Opening Message that appears when the radio is powered ON.	OFF/DC/MESSAGE	MESSAGE
28: PAG CD-R	Setting the Receiver Pager Code for the Enhanced CTCSS Paging & Code Squelch function.	---	05 47
29: PAG CD-T	Setting the Transmitting Pager Code for the Enhanced CTCSS Paging & Code Squelch function.	---	05 47
30: PRG P3	Programming the function assigned to Microphone [P3] key.	SQL OFF HOME CD SRCH SCAN T CALL TX POWER DIG/ANA GM WIRES Setup Menu Item #1 to 50	WIRES
31: PRG P4	Programming the function assigned to Microphone [P4] key.		※
32: RADIO ID	Displays the transceiver IDs	※※※※※ (uneditable)	---
33: RF SQL	Adjusts the RF Squelch threshold level.	OFF/S1 to S8	OFF
34: RPT ARS	Activates/Deactivates the Automatic Repeater Shift feature.	ON/OFF	ON
35: RPT FREQ	Sets the magnitude of the Repeater Shift.	0.00 - 150.00 (MHz)	※
36: RPT SFT	Sets the Repeater Shift direction.	-RPT/+RPT/SIMPLEX	SIMPLEX
37: SCAN RSM	Selects the Scan Resume mode.	BUSY/HOLD/2-10 (SEC)	5.0 SEC

Setup (Menu) Mode

Menu Item	Function	Available Values	Default
38: SCAN SKP	Selects the Memory Scan mode.	OFF/SKIP/SELECT	OFF
39: SQL EXP	Enables/Disables the split CTCSS/DCS coding.	ON/OFF	OFF
40: SQL TYPE	Selects the Tone Encoder and/or Decoder mode.	TONE/TSQ/DCS/RV TONE/PAGER/OFF	OFF
41: STEP	Sets the frequency synthesizer steps.	AUTO/5/6.25/10/12.5/15/20/25/50/100 (kHz)	AUTO
42: TEMP	Indicates the current temperature inside the transceiver.	---	---
43: TONE FRQ	Setting of the CTCSS Tone Frequency.	67.0 to 254.1 (Hz)	100.0 HZ
44: TOT	Sets the Time-Out Timer.	0.5 to 10.0 (MIN)/OFF	3.0 MIN
45: TS MUTE	Enables/Disables the receiver audio output while the Tone Search or DCS Search Scanner is activated.	ON/OFF	ON
46: TS SPEED	Selects the Tone Search or DCS Search Scanner speed.	FAST/SLOW	FAST
47: VER DISP	Displays the transceiver software version	CPU x.xx DSP x.xx	---
48: W/N DEV	Reduction of the Microphone Gain/Deviation and receiver bandwidth.	WIDE/NARROW	WIDE
49: W-DGID	Setting of the WIRES-X DGID	AUTO/DGID01-99	AUTO
50: MY CALL	Sets your station call sign	-----	---

※: Depends on the transceiver version.

Care and maintenance

Turn the power OFF before wiping away any dust and stains on the transceiver with a dry soft cloth. For stubborn stains, slightly moisten a soft cloth and wring it out before using it to wipe away the stains.

Caution: Never use washing detergents and organic solvents (thinner, benzene, etc.). Doing so may result in paint flaking or damage to the transceiver finish.

Replacing the fuse

When the fuse of the DC power supply cable blows and the transceiver becomes inoperable, correct the cause of the problem, and then replace the fuse with a new one of the correct rating (USA version: 25 Amp, EXP/European version: 20 Amp).

Caution: When replacing the fuse, be sure to disconnect the power supply cable from the transceiver and from the external DC power supply.

Replacing the fuse of the DC power supply cable

1. Prepare a new fuse.

Use a fuse with a rating of 25 A or 20 A.

Caution: Never attempt to use a fuse that is not of the specified rating.

USA version: 25 Amp

EXP/European version: 20 Amp

2. Open the fuse holder as shown in the diagram on the right.
3. Remove the blown fuse.
4. Attach the new fuse.
5. Close the fuse holder.

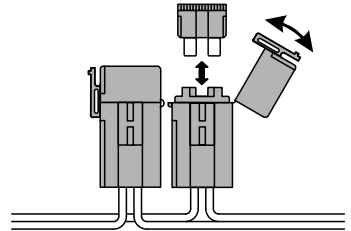

Specifications

General

Frequency Range:	Tx 430 - 450 MHz(USA version) 430 - 440 MHz(European version) 420 - 470 MHz(Asian version) Rx 420 - 470 MHz
Channel Step:	5/6.25/10/12.5/15/20/25/50/100 kHz
Standard Repeater Shift:	±5 / 7.6 MHz
Frequency Stability:	±2.5 ppm [-4 °F to +140 °F (-20 °C to +60 °C)]
Modes of Emission:	F2D/F3E/F7W
Antenna Impedance:	50 Ohms, unbalanced
Supply voltage:	13.8 V DC ±15%, negative ground
Current Consumption (typical):	Rx: less than 0.7 A, less than 0.5 A (squelched) Tx: 10 A (55 W) /6 A (25 W) /3 A (5 W)
Operating Temperature Range:	-4° F to +140° F (-20° C to +60° C)
Case Size (WxHxD):	6.1" x 1.7" x 6.1" (154 x 43 x 155 mm) (w/o knobs)
Weight (Approx.):	2.86 lbs (1.3 kg)

Transmitter

Output Power:	55/25/5 W
Modulation Type:	F2D/F3E: Variable Reactance F7W: 4FSK (C4FM)
Maximum Deviation:	±5 kHz (Wide) ±2.5 kHz (Narrow)
Spurious Radiation:	Better than -60 dB Better than -61.1 dB (European version, 55 W)
Microphone Impedance:	2k Ohms

Receiver

Circuit Type:	Double Conversion Superheterodyne
I _f s:	1st 47.25 MHz, 2nd 450 kHz
Sensitivity (for 12dB SINAD):	0.20 µV (Ham band, wide) 0.22 µV (Ham band, narrow)
Sensitivity (for Digital):	0.22 µV (BER 1%)
Selectivity (-6/-60dB):	12 kHz/28 kHz
Maximum AF Output:	3 W into 4 Ohms with 10% THD

Specifications are subject to change without notice, and are guaranteed within the 430 MHz amateur bands only. Frequency ranges will vary according to transceiver version; check with your dealer.

An amateur band radio doesn't require Certification/Verification for the transmitter under Part 97

- Changes or modifications to this device that are not expressly approved by YAESU MUSEN could void the user's authorization to operate this device.
- This device complies with part 15 of the FCC Rules. Operation is subject to the following two conditions: (1) This device may not cause harmful interference, and (2) this device must accept any interference including received, interference that may cause undesired operation.
- The scanning receiver in this equipment is incapable of tuning, or readily being altered, by the User to operate within the frequency bands allocated to the Domestic public Cellular Telecommunications Service in Part 22.
- The YAESU MUSEN is not responsible for any changes or modifications not expressly approved by the party responsible for compliance. Such modifications could void the user's authority to operate the equipment.

This device complies with ISSED's applicable license-exempt RSS standard(s). Operation is subject to the following two conditions: (1) this device may not cause interference, and (2) this device must accept any interference, including interference that may cause undesired operation of the device.

Le présent appareil est conforme aux CNR d'Industrie Canada applicables aux appareils radio exempts de licence. L'exploitation est autorisée aux deux conditions suivantes : (1) l'appareil ne doit pas produire de brouillage, et (2) l'utilisateur de l'appareil doit accepter tout brouillage radioélectrique subi, même si le brouillage est susceptible d'en compromettre le fonctionnement.

DECLARATION BY MANUFACTURER

The Scanner receiver is not a digital scanner and is incapable of being converted or modified to a digital scanner receiver by any user.

WARNING: MODIFICATION OF THIS DEVICE TO RECEIVE CELLULAR RADIOTELEPHONE SERVICE SIGNALS IS PROHIBITED UNDER FCC RULES AND FEDERAL LAW.

CAN ICES-3 (B) / NMB-3 (B)

This equipment has been tested and found to comply with the limits for a Class B digital device, pursuant to part 15 of the FCC Rules. These limits are designed to provide reasonable protection against harmful interference in a residential installation. This equipment generates, uses, and can radiate radio frequency energy; and, if not installed and used in accordance with the instructions, may cause harmful interference to radio communications. However, there is no guarantee that interference will not occur in a particular installation.

If this equipment does cause harmful interference to radio or television reception, which can be determined by turning the equipment off and on, the user is encouraged to try to correct the interference by one or more of the following measures:

- Reorient or relocate the receiving antenna.
- Increase the separation between the equipment and receiver.
- Connect the equipment into an outlet on a circuit different from that to which the receiver is connected.
- Consult the dealer or an experienced radio/TV technician for help.

YAESU

Declaration of Conformity

Type of Equipment:	UHF DIGITAL/ANALOG TRANSCEIVER
Brand Name:	YAESU
Model Number:	FTM-3207DR
Manufacturer:	YAESU MUSEN CO., LTD.
Address of Manufacturer:	Tennozu Parkside Building, 2-5-8 Higashi-Shinagawa, Shinagawa-ku, Tokyo 140-0002 Japan

This device complies with part 15 of the FCC Rules. Operation is subject to the following two conditions; (1) this device may not cause harmful interference, and (2) this device must accept any interference received, including interference that may cause undesired operation.

The technical documentation as required by the Conformity Assessment procedures is kept at the following address:

Company: Yaesu U.S.A.
Address: 6125 Phyllis Drive, Cypress, CA 90630, U.S.A.
Telephone: (714) 827-7600

EU Declaration of Conformity

We, Yaesu Musen Co. Ltd of Tokyo, Japan, hereby declare that this radio equipment FTM-3207DE is in full compliance with EU Radio Equipment Directive 2014/53/EU. The full text of the Declaration of Conformity for this product is available to view at <http://www.yaesu.com/jp/red>

ATTENTION – Conditions of usage

This transceiver works on frequencies that are regulated and not permitted to be used without authorisation in the EU countries shown in this table. Users of this equipment should check with their local spectrum management authority for licensing conditions applicable for this equipment.

					
AT	BE	BG	CY	CZ	DE
DK	ES	EE	FI	FR	UK
GR	HR	HU	IE	IT	LT
LU	LV	MT	NL	PL	PT
RO	SK	SI	SE	CH	IS
LI	NO	-	-	-	-

Disposal of Electronic and Electrical Equipment

Products with the symbol (crossed-out wheeled bin) cannot be disposed as household waste.

Electronic and Electrical Equipment should be recycled at a facility capable of handling these items and their waste by-products.

Please contact a local equipment supplier representative or service center for information about the waste collection system in your country.



YAESU

The radio

Copyright 2018
YAESU MUSEN CO., LTD.
All rights reserved.

No portion of this manual may be
reproduced without the permission of
YAESU MUSEN CO., LTD.

YAESU MUSEN CO., LTD.

Tennozu Parkside Building
2-5-8 Higashi-Shinagawa, Shinagawa-ku, Tokyo
140-0002 Japan

YAESU USA

6125 Phyllis Drive, Cypress, CA 90630, U.S.A.

YAESU UK

Unit 12, Sun Valley Business Park, Winnall Close
Winchester, Hampshire, SO23 0LB, U.K.

1801I-CO-1
Printed in Japan



E H O 7 5 U 1 0 1