

KENWOOD

INSTRUCTION MANUAL



144/440 MHz FM DUAL BANDER

TM-V71A

144/430 MHz FM DUAL BANDER

TM-V71A/ TM-V71E

This equipment complies with the essential requirements of Directive 1999/5/EC.

The use of the warning symbol  means the equipment is subject to restrictions of use in certain countries.

This equipment is intended for use in all EU countries and CH, LI, IS and NO, and requires a license.

Kenwood Corporation

© B62-1926-00 (K, E, M4)
09 08 07 06 05 04 03 02 01 00

 0682 

THANK YOU

We are grateful you decided to purchase this **Kenwood** FM transceiver. **Kenwood** always provides Amateur Radio products which surprise and excite serious hobbyists. This transceiver is no exception. **Kenwood** believes that this product will satisfy your requirements for both voice and data communications.

FEATURES

This transceiver has the following main features:

- Enhanced Programmable Memory (PM) channels store virtually entire current operating environments for your quick recall.
- Contains a total of 1000 Memory channels to program frequencies and other various data. Allows each Memory channel to be named using up to 6 alphanumeric characters.
- Continuous Tone Coded Squelch System (CTCSS) or Digital Code Squelch (DCS) rejects unwanted calls from other stations.

WRITING CONVENTIONS FOLLOWED IN THIS MANUAL

The writing conventions described below have been followed to simplify instructions and avoid unnecessary repetition.

Instruction	Action
Press [KEY].	Momentarily press KEY.
Press [KEY] (1s).	Press and hold KEY for 1 second or longer.
Press [KEY1], [KEY2].	Press KEY1 momentarily, release KEY1, then press KEY2.
Press [F], [KEY].	Press the F key to enter Function mode, then press KEY to access its secondary function.
Press [KEY] + Power ON.	With the transceiver power OFF, press and hold KEY while turning the transceiver power ON.



Information on Disposal of Old Electrical and Electronic Equipment (applicable for EU countries that have adopted separate waste collection systems)

Products with the symbol (crossed-out wheeled bin) cannot be disposed of as household waste. Old electrical and electronic equipment should be recycled at a facility capable of handling these items and their waste byproducts. Contact your local authority for details in locating a recycle facility nearest to you. Proper recycling and waste disposal will help conserve resources whilst preventing detrimental effects on our health and the environment.

NOTICES TO THE USER

One or more of the following statements may be applicable:

FCC WARNING

This equipment generates or uses radio frequency energy. Changes or modifications to this equipment may cause harmful interference unless the modifications are expressly approved in the instruction manual. The user could lose the authority to operate this equipment if an unauthorized change or modification is made.

INFORMATION TO THE DIGITAL DEVICE USER REQUIRED BY THE FCC

This equipment has been tested and found to comply with the limits for a Class B digital device, pursuant to Part 15 of the FCC Rules. These limits are designed to provide reasonable protection against harmful interference in a residential installation.

This equipment generates, uses and can generate radio frequency energy and, if not installed and used in accordance with the instructions, may cause harmful interference to radio communications. However, there is no guarantee that the interference will not occur in a particular installation. If this equipment does cause harmful interference to radio or television reception, which can be determined by turning the equipment off and on, the user is encouraged to try to correct the interference by one or more of the following measures:

- Reorient or relocate the receiving antenna.
- Increase the separation between the equipment and receiver.
- Connect the equipment to an outlet on a circuit different from that to which the receiver is connected.
- Consult the dealer for technical assistance.

WHEN CONDENSATION OCCURS INSIDE THE TRANSCEIVER

Condensation may occur inside the transceiver in such a case where the room is warmed using a heater on cold days or where the transceiver is quickly moved from a cold room to a warm room. When condensation occurs, the microcomputer and/or the transmit/receive circuits may become unstable, resulting in transceiver malfunction. If this happens, turn OFF the transceiver and just wait for a while. When the condensation droplets disappear, the transceiver will function normally.



WARNING

◆ EXPLOSIVE ATMOSPHERES (GASES, DUST, FUMES, etc.)

Turn OFF your transceiver while taking on fuel or while parked in gasoline service stations. Do not carry spare fuel containers in the trunk of your vehicle if your transceiver is mounted in the trunk area.

◆ INJURY FROM RADIO FREQUENCY TRANSMISSIONS

Do not operate your transceiver when somebody is either standing near to or touching the antenna, to avoid the possibility of radio frequency burns or related physical injury.

◆ DYNAMITE BLASTING CAPS

Operating the transceiver within 150 m (500 feet) of dynamite blasting caps may cause them to explode. Turn OFF your transceiver when in an area where blasting is in progress, or where "TURN OFF TWO-WAY RADIO" signs have been posted. If you are transporting blasting caps in your vehicle, make sure they are carried in a closed metal box with a padded interior. Do not transmit while the caps are being placed into or removed from the container.

PRECAUTIONS

Observe the following precautions to prevent fire, personal injury, and transceiver damage.

- When operating mobile, do not attempt to configure the transceiver while driving; it is too dangerous.
- Do not transmit with high output power for extended periods. The transceiver may overheat.
- Do not disassemble or modify the transceiver for any reason, unless instructed by this manual or by **Kenwood** documentation.
- Do not expose the transceiver to long periods of direct sunlight, nor place it near heating appliances.
- Do not place the transceiver in excessively dusty, humid, or wet areas, nor on unstable surfaces.
- If an abnormal odor or smoke is detected coming from the transceiver, switch the transceiver power off immediately, and contact a **Kenwood** service station or your dealer.
- Use of the transceiver while you are driving may be against traffic laws. Please check and observe the vehicle regulations in your area.
- Do not use options not specified by **Kenwood**.



CAUTION

- ◆ The transceiver is designed for a 13.8 V DC ($\pm 15\%$) power source! Never use a 24 V battery to power the transceiver. Check the battery polarity and voltage of the vehicle before installing the transceiver.
- ◆ Use only the supplied DC power cable or a Kenwood optional DC power cable.
- ◆ Do not insert metal objects into the cooling fan.



WARNING

- ◆ Do not cut and/or remove the fuse holder on the DC power cable. Improper connections and/or current surges may cause smoke or fire.
- ◆ For passenger safety, install the transceiver securely using the supplied mounting bracket and screw set so the transceiver will not break loose in the event of a collision.
- ◆ Various electronic equipment in your vehicle may malfunction if they are not properly protected from the radio frequency energy which is present while transmitting. Electronic fuel injection, anti-skid braking, and cruise control systems are typical examples of equipment that may malfunction. If your vehicle contains such equipment, consult the dealer for the make of vehicle and enlist his/her aid in determining if they will perform normally while transmitting.

CONTENTS

PREPARATION	1
SUPPLIED ACCESSORIES	1
MOBILE INSTALLATION	1
POWER CABLE CONNECTION	2
ANTENNA CONNECTION.....	5
FRONT PANEL ORIENTATION	6
ACCESSORY CONNECTIONS	7
GETTING ACQUAINTED.....	8
FRONT PANEL.....	8
DISPLAY.....	10
REAR PANEL	12
SUB-PANEL	12
MICROPHONE (MC-59)	13
BASIC OPERATIONS.....	14
SWITCHING THE POWER ON/ OFF	14
ADJUSTING THE VOLUME	14
ADJUSTING THE SQUELCH.....	15
SELECTING A BAND.....	15
SELECTING DUAL BAND MODE/ SINGLE BAND MODE	16
SELECTING A FREQUENCY BAND	17
SELECTING AN OPERATING MODE	18
TRANSMITTING	19
MENU MODE	20
MENU ACCESS.....	20
MENU CONFIGURATION	20
CHARACTER ENTRY	24
OPERATING THROUGH REPEATERS	26
REPEATER ACCESS.....	26
TRANSMITTING A 1750 Hz TONE	30
REVERSE FUNCTION.....	30
AUTOMATIC SIMPLEX CHECKER (ASC)	30
TONE FREQUENCY ID	31

MEMORY CHANNELS	32
SIMPLEX & REPEATER OR ODD-SPLIT MEMORY CHANNEL?	32
STORING SIMPLEX AND STANDARD REPEATER FREQUENCIES	33
STORING ODD-SPLIT REPEATER FREQUENCIES	33
RECALLING A MEMORY CHANNEL	34
CLEARING A MEMORY CHANNEL	35
NAMING A MEMORY CHANNEL	35
SWITCHING THE MEMORY NAME/ FREQUENCY DISPLAY	36
MEMORY-TO-VFO TRANSFER.....	36
CHANNEL DISPLAY FUNCTION.....	36
PROGRAMMABLE MEMORY (PM).....	38
APPLICATION EXAMPLES	39
STORING DATA IN PM CHANNELS	40
RECALLING PM CHANNELS	40
AUTO PM CHANNEL STORE.....	41
PM CHANNEL RESET	41
SCAN	42
SELECTING A SCAN RESUME METHOD	43
VFO SCAN.....	43
MEMORY SCAN	44
GROUP SCAN	45
PROGRAM SCAN	46
MHz SCAN.....	48
CALL SCAN.....	48
CONTINUOUS TONE CODED SQUELCH SYSTEM (CTCSS)	49
USING CTCSS.....	49
CTCSS FREQUENCY ID	51
DIGITAL CODED SQUELCH (DCS).....	52
USING DCS	52
DCS CODE ID.....	54
DUAL TONE MULTI-FREQUENCY (DTMF)	55
MANUAL DIALING	55
AUTOMATIC DIALER	56

DTMF KEY LOCK	58
EchoLink®	59
WHAT IS EchoLink?	59
STORING EchoLink MEMORY	59
SETTING UP EchoLink Sysop MODE	61
AUXILIARY FUNCTIONS	62
POWER-ON MESSAGE	62
DISPLAY BRIGHTNESS	62
KEY LOCK	63
KEY BEEP	64
PROGRAMMABLE VFO	64
CHANGING THE FREQUENCY STEP SIZE	65
PROGRAMMABLE FUNCTION KEYS	66
FREQUENCY DIRECT ENTRY	67
AUTOMATIC POWER OFF (APO)	67
S-METER SQUELCH	68
ADVANCED INTERCEPT POINT (AIP)	68
SWITCHING FM/AM MODE	69
BEAT SHIFT	69
SPEAKER MUTE	69
SELECTING AN OUTPUT POWER	70
TIME-OUT TIMER (TOT)	70
EXTERNAL SPEAKER CONFIGURATION	71
MASKING A BAND	71
DISPLAY PARTITION BAR	72
WEATHER ALERT (K TYPE MODELS ONLY)	73
POWER ON PASSWORD	74
VGS-1 OPTIONAL VOICE GUIDE & STORAGE UNIT	75
VOICE ANNOUNCEMENTS	75
VOICE RECORDER	78
CROSS-BAND/ LOCKED-BAND OPERATION (K TYPE MODELS ONLY)	81
REPEATER HOLD	82
REPEATER ID	82

PACKET OPERATION	83
DATA BAND	83
DATA TERMINAL SPEED.....	83
PC PORT SPEED	84
SQC OUTPUT SETTING	84
WIRELESS OPERATION (K TYPE MODELS ONLY).....	85
PREPARATION	85
CONTROL OPERATION	86
TRANSCEIVER RESET	87
OPTIONS	89
MEMORY CONTROL PROGRAM MCP-2A.....	89
CONNECTING THE PG-5G/ PG-5H INTERFACE CABLES.....	90
INSTALLING THE DFK-3D PANEL KIT	90
CONNECTING THE PG-5F EXTENSION CABLE	92
INSTALLING THE VGS-1 UNIT	93
MAINTENANCE	94
GENERAL INFORMATION	94
SERVICE.....	94
SERVICE NOTE.....	94
CLEANING.....	94
TROUBLESHOOTING.....	95
SPECIFICATIONS	96

PREPARATION

SUPPLIED ACCESSORIES

Note: A type code (K, E, or M4) can be found on the label attached to the package box.

Item		Part Number	Quantity
Microphone		T91-0657-XX	1
DC power cable (with 20 A fuses)	K, M4 types	E30-7628-XX	1
	E type	E30-3452-XX	1
Mounting bracket		J29-0628-XX	1
Screw set		N99-0331-XX	1
Fuse (15 A)	K, M4 types	F51-0079-XX	1
	E type	F52-0024-XX	1
Warranty Card	K, E types only	--	1
Instruction manual		B62-1926-XX	1

MOBILE INSTALLATION

Select a safe, convenient location inside your vehicle that will minimize danger to your passengers and yourself while the vehicle is in motion. Consider installing the transceiver under the dash in front of the passenger seat so that knees or legs will not strike the radio during sudden braking of your vehicle. Try to pick well-ventilated location that is shielded from direct sunlight.

Note: You may experience interference on your GPS receiver when using in or around 438.8 MHz (A band) and/or 443.8 MHz (B band). To eliminate the interference, ensure that the transceiver is installed at a location separate from your GPS receiver.

- 1 Install the mounting bracket in the vehicle using the supplied self-tapping screws and flat washers (4 of each are supplied).
 - The bracket can be mounted with the bracket opening facing down, for underdash mounting, or facing up.
 - The bracket must be installed so that the 3 screw slots on the edge of each bracket side are facing the back.

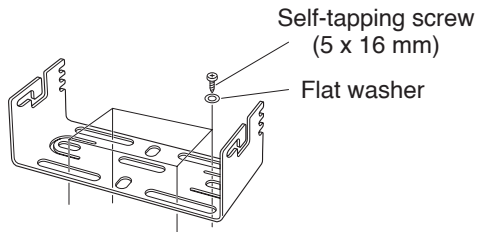

- 2 Position the transceiver, then insert and tighten the supplied hexagon SEMS screws and flat washers (4 of each are supplied, 2 for each side of the bracket).
 - Ensure that all hardware is tightened, to prevent vehicle vibration from loosening the bracket or transceiver.

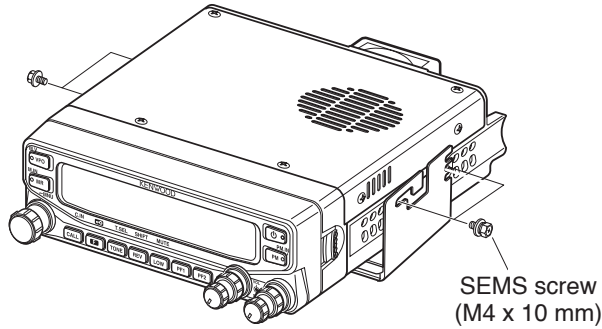

- Set an appropriate angle for the main unit, using the 3 screw slots on the rear edge of each bracket side.

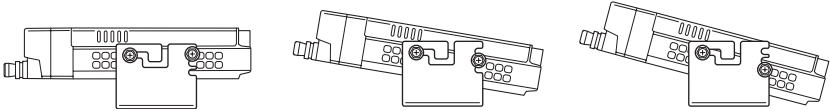

POWER CABLE CONNECTION

■ Mobile Operation

Be sure to use a 12 V vehicle battery that has sufficient current capacity. If the current to the transceiver is insufficient, the display may darken during transmission or the transmit output power may drop excessively. Never connect the transceiver to a 24 V battery

Note: If you use the transceiver for a long period when the vehicle battery is not fully charged or when the engine is OFF, the battery may become discharged and will not have sufficient reserves to start the vehicle. Avoid using the transceiver under these conditions.

- 1 Route the DC power cable supplied with the transceiver directly to the vehicle's battery terminals using the shortest path from the transceiver.
 - When using a noise filter, it should be installed with an insulator to prevent it from touching metal on the vehicle.
 - We do not recommend using a cigarette lighter socket as some cigarette lighter sockets introduce an unacceptable voltage drop.
 - If the power cable must be routed through a hole in the vehicle chassis or body, for example in the firewall at the front of the passenger compartment, use a rubber grommet to protect the cable from abrasion. Dismantle the fuse holder to pass the cable through the firewall.
 - The entire length of the cable must be dressed so it is isolated from heat, moisture, and the engine secondary (high voltage) ignition system/ cables.

- 2 After the cable is in place, wind heat-resistant tape around the fuse holder to protect it from moisture. Tie down the full run of cable.
- 3 To prevent the risk of short circuits, disconnect other wiring from the negative (-) battery terminal before connecting the transceiver.
- 4 Confirm the correct polarity of the connections, then attach the power cable to the battery terminals; red connects to the positive (+) terminal and black connects to the negative (-) terminal.
 - Use the full length of the cable without cutting off excess, even if the cable is longer than required. In particular, never remove the fuse holders from the cable.
- 5 Reconnect any wiring removed from the negative terminal.
- 6 Connect the DC power cable to the transceiver.
 - Press the connectors firmly together until the locking tab clicks.

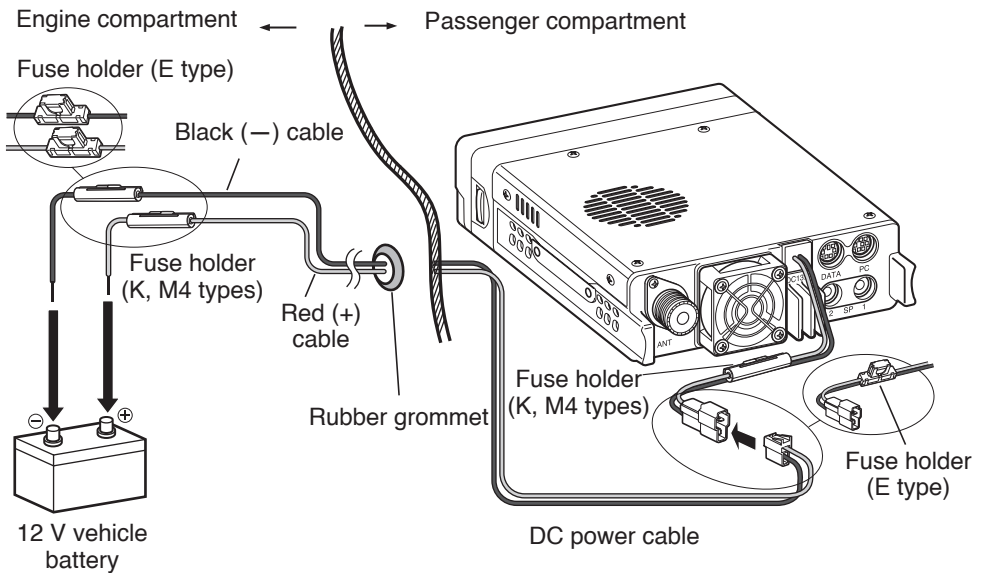

■ Fixed Station Operation

In order to use this transceiver for fixed station operation, you will need a separate 13.8 V DC power supply that must be purchased separately. The recommended current capacity of the power supply is 12 A.

Note: Do not plug the DC power supply into an AC outlet until you make all connections.

- 1 Ensure that the transceiver and DC power supply are both OFF.
- 2 Connect the DC power cable to the regulated DC power supply and ensure that the polarities are correct (Red: positive, Black: negative).
 - Use the supplied DC power cable to connect the transceiver to a regulated power supply. Do not directly connect the transceiver to an AC outlet.
 - Do not substitute the cable with smaller gauge wires.

3 Connect the DC power cable to the transceiver.

- Press the connectors firmly together until the locking tab clicks.

Note: For your transceiver to fully exhibit its performance capabilities, we recommend using an optional PS-33 (20.5 A, 25% duty cycle) power supply.

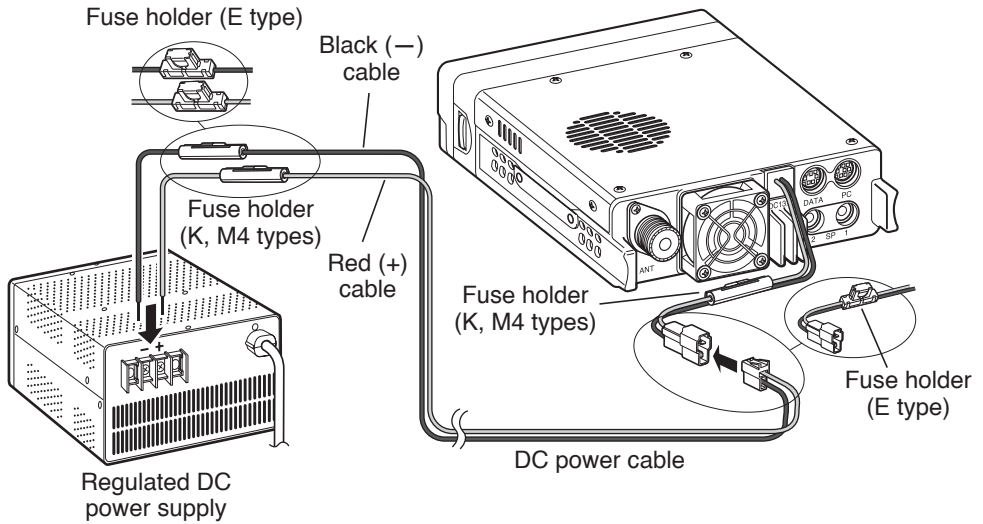

■ Replacing Fuses

If the fuse blows, determine the cause, then correct the problem. After the problem is resolved, replace the fuse. If newly installed fuses continue to blow, disconnect the power cable and contact your authorized **Kenwood** dealer or an authorized **Kenwood** service center for assistance.

Fuse Location	Fuse Current Rating
Transceiver (located on the DC connector)	15 A
Supplied DC power cable	20A



Only use fuses of the specified type and rating; otherwise the transceiver could be damaged.

Fuse holder (E type)

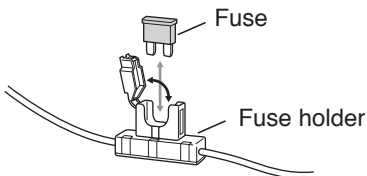

Fuse holder (K, M4 types)

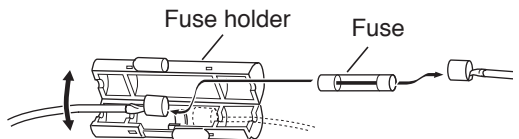

ANTENNA CONNECTION

Before operating, you must first install an efficient, well-tuned antenna. The success of your installation will depend largely on the type of antenna and its correct installation. The transceiver can give excellent results if the antenna system and its installation are given careful attention.

Use a low-loss coaxial feed line that also has a characteristic impedance of $50\ \Omega$, to match the transceiver input impedance. Coupling the antenna to the transceiver via feed lines having an impedance other than $50\ \Omega$ reduces the efficiency of the antenna system and can cause interference to nearby broadcast television receivers, radio receivers, and other electronic equipment.



CAUTION

- ◆ Transmitting without first connecting an antenna or other matched load may damage the transceiver. Always connect the antenna to the transceiver before transmitting.
- ◆ All fixed stations should be equipped with a lightning arrester to reduce the risk of fire, electric shock, and/or transceiver damage.

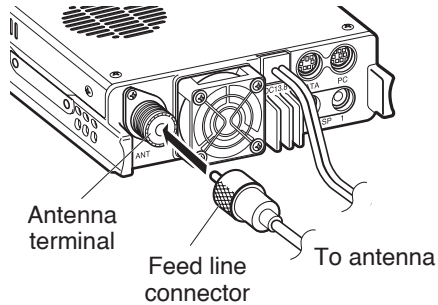

FRONT PANEL ORIENTATION

This transceiver allows you to change the orientation of the front panel. Depending on where/how you installed the transceiver you may wish to flip the front panel upside-down for easier operation.

- 1 On the right side of the front panel, pull the panel release latch forward.

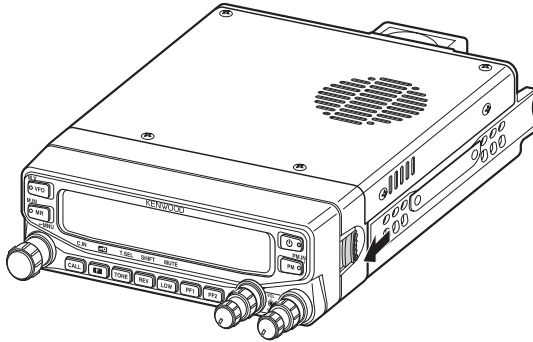

- 2 Slide the front panel to the left, then pull it away from the main body of the transceiver.

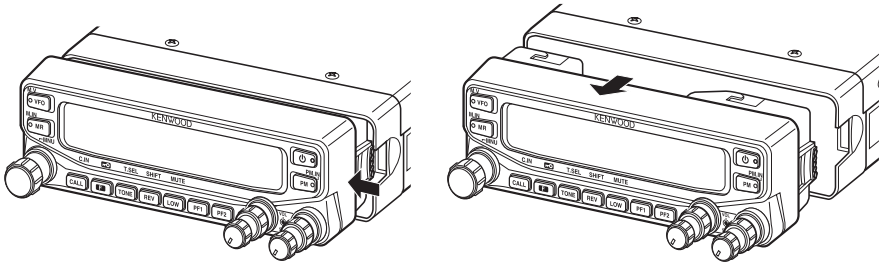

- 3 Flip the front panel upside-down, then reattach it to the main body of the transceiver.

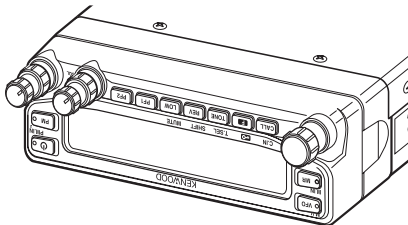

ACCESSORY CONNECTIONS

External Speakers

If you plan to use external speakers, choose speakers with an impedance of 8 Ω. The external speaker jacks accept a 3.5 mm (1/8") mono (2-conductor) plug. We recommend using SP-50B speakers.

There are 2 speaker jacks on the rear of the transceiver: SP 1 and SP 2. Refer to page 71 to determine how the speakers will be used.

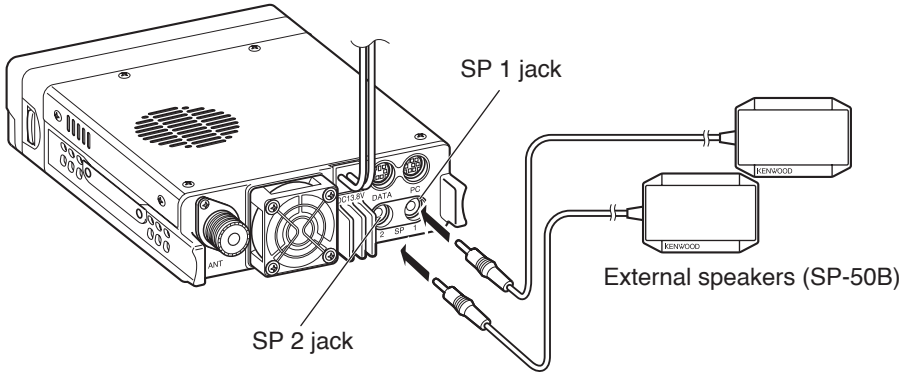

Microphone

To communicate using voice, connect the supplied microphone to the MIC jack on the left side of the transceiver. Press firmly on the plug until the locking tab clicks.

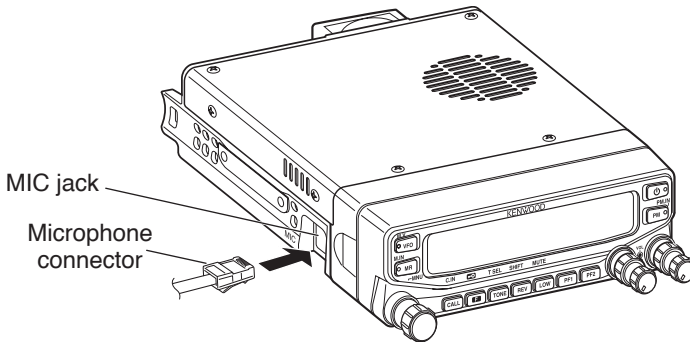

GETTING ACQUAINTED

FRONT PANEL

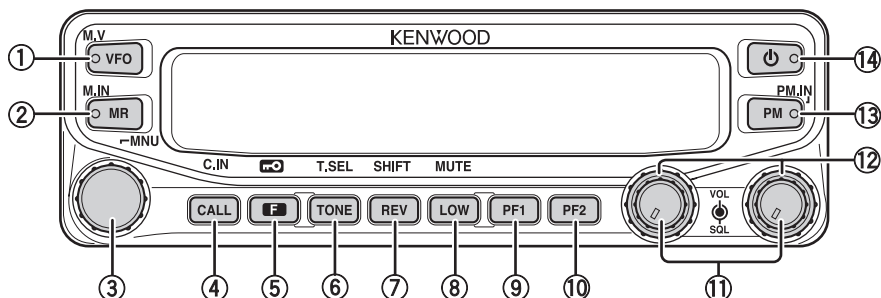

- ① **VFO**
Press **[VFO]** to enter VFO mode {page 18}, then rotate the **Tuning** control to select an operating frequency. Press **[VFO] (1s)** to start VFO scan {page 43}. Press **[F], [VFO]** to copy the current Memory channel or Call channel to the VFO (memory shift) {page 36}.
- ② **MR**
Press **[MR]** to enter Memory Channel mode {page 18}, then rotate the **Tuning** control to select a Memory channel. Press **[MR] (1s)** to start Memory scan {page 44}. Select a Memory channel, then press **[F], [MR]** to store the current operating frequency in the Memory channel {page 33}.
- ③ **Tuning Control**
Rotate to select an operating frequency or Memory channel, change the scan direction, select a tone frequency, etc. Press the **Tuning** control to enter MHz mode (while in VFO or Call mode) or to toggle the display between the channel name and frequency (while in Memory Channel mode). Press **[F]**, then press the **Tuning** control to enter Menu mode {page 20}. Press the **Tuning** control **(1s)** to start MHz scan {page 48} or Group scan {page 45}.
- ④ **CALL**
Press **[CALL]** to select the Call channel. Press **[CALL] (1s)** to start Call scan {page 48}. Press **[F], [CALL]** to store the current operating frequency to the Call channel {page 33}.
- ⑤ **F**
Press **[F]** to enter Function mode. Press **[F] (1s)** to turn the transceiver key lock function ON or OFF {page 63}.
- ⑥ **TONE**
Press **[TONE]** to turn the Tone function ON. Continually press **[TONE]** to toggle the functions as follows: Tone ON >> CTCSS ON >> DCS ON >> OFF. While Tone, CTCSS, or DCS is ON, press **[F], [TONE]** to enter CTCSS or DCS setup mode.

⑦ **REV**

Press **[REV]** to turn the Reverse function ON or OFF {page 30}. Press **[REV]** (**1s**) to turn the Automatic Simplex Checker ON {page 30}. Press **[F]**, **[REV]** to enter Offset Direction selection mode. Each time you press **[F]**, **[REV]**, the offset direction toggles as follows:
plus (+) direction → minus (-) direction → -7.6 MHz (E type only) → OFF.

⑧ **LOW**

Press **[LOW]** to toggle the transmit output power as follows: High Power (K, E types only) → Middle Power → Low Power {page 70}. Press **[F]**, **[LOW]** to turn the Mute function ON or OFF {page 69}.

⑨ **PF1**

Press **[PF1]** to activate its programmable function {page 66}. The default function is "Frequency Band Select".

⑩ **PF2**

Press **[PF2]** to activate its programmable function {page 66}. The default function is "Operation Band Select".

⑪ **BAND SEL (VOL) Control**

Rotate the **[BAND SEL]** control to adjust the speaker volume {page 14}. Press the left **[BAND SEL]** to select the A band. Press the right **[BAND SEL]** to select the B band. Press **[BAND SEL]** (**1s**) to toggle between single and dual-band mode.

⑫ **SQL Control**

Rotate the **[SQL]** control to adjust the squelch level. Clockwise opens the squelch and counterclockwise tightens the squelch {page 68}.

⑬ **PM**

Press **[PM]** to enter the PM (Programmable Memory) channel selection mode {page 40}. Press **[F]**, **[PM]** to enter PM Channel registration mode {page 40}.



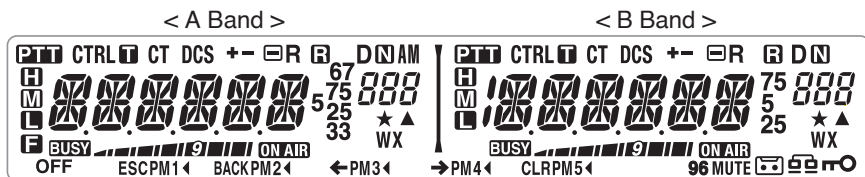

⑭ **⏻**

Press **[⏻]** to turn the transceiver power ON and OFF.

DISPLAY



Indicator	Description
PTT	Appears when there is a transmission band available. Blinks when the cross-band repeater is ON (K type only).
CTRL	Appears when there is an operation band available. Blinks when the wireless remote control is ON (K type only).
T	Appears when the Tone function is ON.
CT	Appears when the CTCSS function is ON.
DCS	Appears when the DCS function is ON.
+	Appears when the Shift function is set to plus.
-	Appears when the Shift function is set to minus.
R	Appears when the Reverse function is ON.
R	Appears when the ASC function is ON. Blinks when the ASC function is performing an OK check.
AM	Appears while in AM mode.
N	Appears while in Narrow FM mode.
▲	Appears when the selected channel is registered while in Memory Input mode.
888	Displays the Memory channel and Menu number.
★	Appears when the Memory Channel Lockout function is ON.
H	Appears while using High output power. Blinks when the temperature protection circuit turns on.
M	Appears while using Middle output power. Blinks when the temperature protection circuit turns on.
L	Appears while using Low output power.
10.000000	Displays the operating frequency, Memory channel name, and Menu.
BUSY	Appears when receiving a busy signal.
▬▬▬▬▬▬▬▬▬▬▬▬	Performs as an S meter when receiving a signal and displays the selected power level while transmitting.
ON AIR	Appears while transmitting.

Indicator	Description
D	Appears while using the data band.
96	Appears when the data terminal is set as 9600 (bps).
25	Appears when the frequency is set to ***,***,250 Hz.
5	Appears when the frequency is set to ***,***,500 Hz.
75	Appears when the frequency is set to ***,***,750 Hz.
33	Appears when the frequency is set to ***,***,333 Hz.
67	Appears when the frequency is set to ***,***,666 Hz.
	Appears when the F key is pressed.
MUTE	Appears when mute has been turned ON.
	Appears while making a conversation recording.
	Appears while in EchoLink Sysop mode.
	Appears when the Key Lock function is ON.
OFF	Appears when making a PM channel call.
ESC	Appears while in Menu mode and when the Tone/CTCSS/DCS code is selected.
PM1 ◀	Blinks when recalling a PM channel and while writing to memory. Only the “1” will blink while recording or in playback mode.
BACK	Appears while accessing the Menu.
PM2 ◀	Blinks when recalling a PM channel and while writing to memory. Only the “2” will blink while recording or in playback mode.
←	Appears when entering characters in Menu mode or entering a code.
PM3 ◀	Blinks when recalling a PM channel and while writing to memory. Only the “3” will blink while recording or in playback mode
→	Appears when entering characters in Menu mode or entering a code.
PM4 ◀	Blinks when recalling a PM channel and while writing to memory. Only the “4” will blink while recording or in playback mode.
CLR	Appears when entering characters in Menu mode or entering a code.
PM5 ◀	Blinks when recalling a PM channel and while writing to memory.
WX	Appears when Weather Alert is ON. Blinks when receiving a signal (K type only).

REAR PANEL

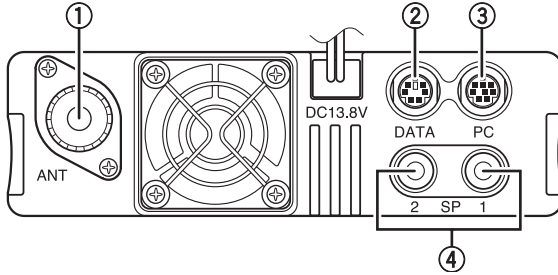

- ① **ANT**
Connect an M-type (TM-V71A) or N-type (TM-V71E) external antenna to this terminal {page 5}. When making test transmissions, connect a dummy load in place of the antenna. The antenna system or load should have an impedance of 50 Ω .
- ② **DATA**
Connect a TNC unit to this terminal, via a 6-pin mini DIN connector.
- ③ **PC**
Connect a personal computer to this terminal, via an 8-pin mini DIN connector.
- ④ **SP (SP 1 / SP 2)**
If desired, connect 1 or 2 external speakers for clearer audio. These jacks accept 3.5 mm (1/8") diameter, 2-conductor plugs {page 7}. Refer to page 71 to determine how the speakers will be used.

SUB-PANEL

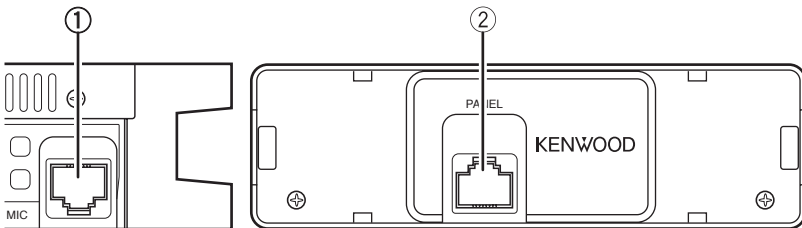

- ① **MIC**
Connect the supplied microphone to this jack {page 7}.
- ② **PANEL**
When using an optional panel kit, attach the panel to this terminal using the cable that comes with the panel kit.

MICROPHONE (MC-59)

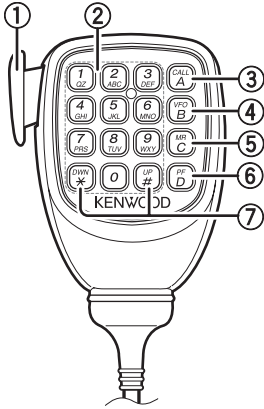

Microphone Jack

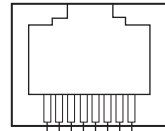

- ⑧ Keypad serial data
- ⑦ No Connection
- ⑥ MIC, 600 Ω impedance
- ⑤ GND (MIC)
- ④ PTT
- ③ GND
- ② DC 8 V, 100 mA max
- ① No Connection

- ① **PTT switch**
Press and hold, then speak into the microphone to transmit.
- ② **DTMF keypad**
Press these keys to make DTMF calls, enter frequencies, or enter characters.
- ③ **CALL/ A**
Functions the same as the transceiver front panel **[CALL]** key. This is also the PF4 key and can be reprogrammed with a programmable function {page 66}.
- ④ **VFO/ B**
Functions the same as the transceiver front panel **[VFO]** key. This is also the PF3 key and can be reprogrammed with a programmable function {page 66}.
- ⑤ **MR/ C**
Functions the same as the transceiver front panel **[MR]** key. This is also the PF2 key and can be reprogrammed with a programmable function {page 66}.
- ⑥ **PF/ D**
Press to toggle between bands A and B. This is also the PF1 key and can be reprogrammed with a programmable function {page 66}.
- ⑦ **UP/ DWN**
Functions the same as the transceiver **Tuning** control.

BASIC OPERATIONS

SWITCHING THE POWER ON/ OFF

Press the **[PWR]** switch to switch the transceiver ON.

- The power on message momentarily appears on the display.
- If the transceiver power on password has been activated {page 74}, you must first enter your password before you can operate the transceiver.

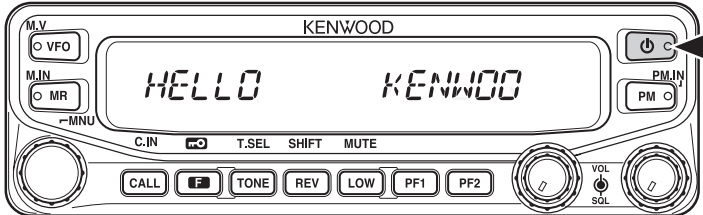

Press the **[PWR]** switch again to switch the transceiver OFF.

ADJUSTING THE VOLUME

Rotate the **[BAND SEL] (VOL)** control of your selected band clockwise to increase the volume and counterclockwise to decrease the volume.

Note: Some functions of this transceiver, such as the beep and voice announcements, have their own volume settings. Adjust those settings to your desired values.

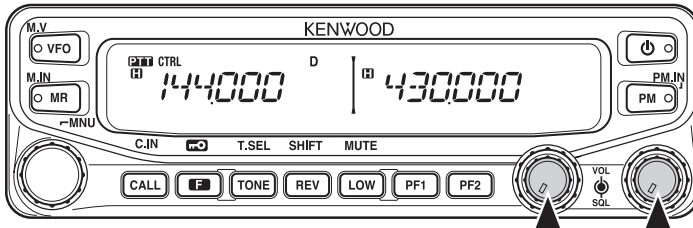

ADJUSTING THE SQUELCH

Squelch is used to mute the speaker when no signals are present. With the squelch level set correctly, you will hear sound only while actually receiving a signal. The higher the squelch level selected, the stronger the signals must be in order to hear them.

Rotate the **[SQL]** control of your selected band, when no signals are present, and select the squelch level at which the background noise is just eliminated.

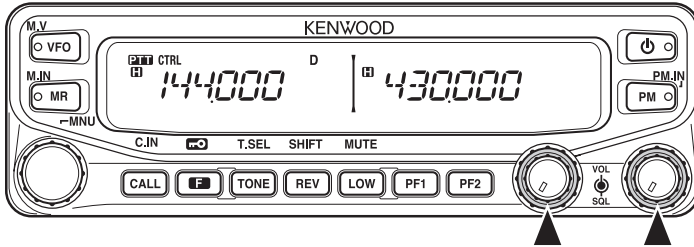

SELECTING A BAND

Press the left **[BAND SEL]** control to select band A and the right **[BAND SEL]** control to select band B.

- The **CTRL** icon appears at the top of the band on which you are operating and the **PTT** icon appears at the top of the band on which you are currently set to transmit.

Band A (left **[BAND SEL]** control):

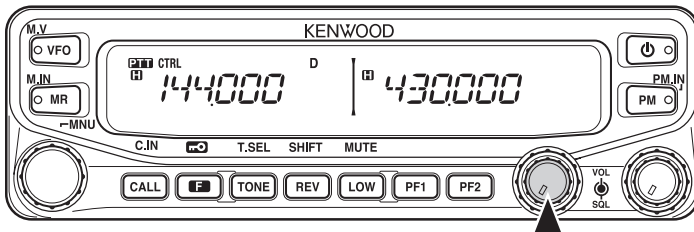

Band B (right **[BAND SEL]** control):

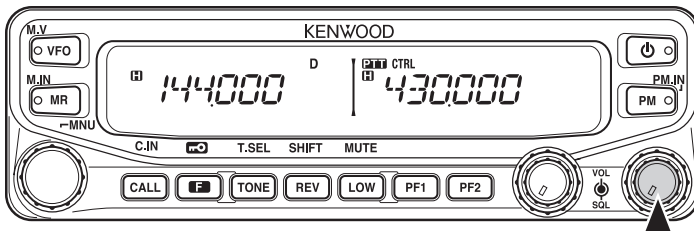

Pressing **[PF2]** allows you to switch the operating band between bands A and B, while maintaining the original band as the transmit band.

Band A is the transmit band and band B is the operating band:

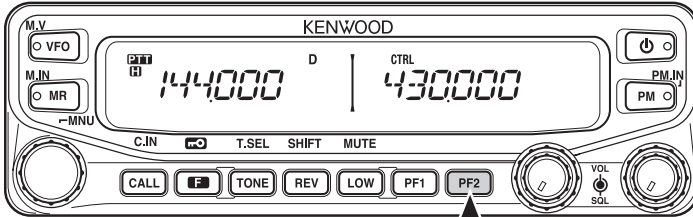

Band A is both the transmit and operating band:

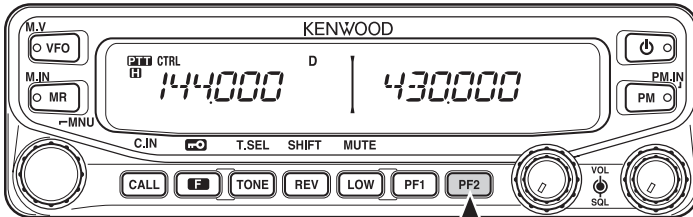

SELECTING DUAL BAND MODE/ SINGLE BAND MODE

You can switch the transceiver between dual band operation and single band operation by pressing **[BAND SEL] (1s)** of your selected band.

Dual band mode:

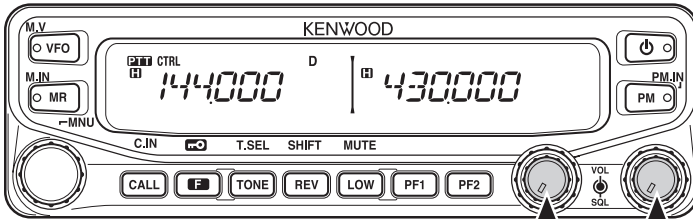

Single band mode (band A only):

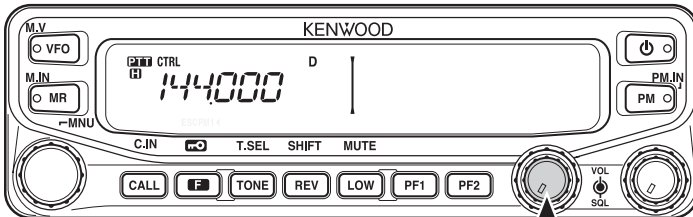

Note: You can also turn the center portion display off {page 72}.

SELECTING A FREQUENCY BAND

You can change the default frequency bands for bands A and B.

- 1 Select band A or B by pressing the **[BAND SEL]** control or **[PF2]**.
- 2 Press **[F]**, **[BAND SEL]** of your selected band.
 - Each time you press **[F]**, **[BAND SEL]**, you cycle to the next frequency band.
 - The default setting of the **[PF1]** key also allows you to cycle to the next frequency band.
 - When masking a band {page 71}, you are restricted to using only the selectable band.
 - When receiving 2 signals on the same band, the image interference, sensitivity, etc., performance will decrease.
 - Band A: 118 >> 144 (default) >> 220 >> 300 >> 430/440 (MHz).
 - Band B: 144 >> 220 >> 300 >> 430/440 (default) >> 1200 (MHz).

Note:

- ◆ M4 type models do not have the following frequency bands available:
118, 220, 300, or 1200 (MHz).
 - ◆ E and M4 type models use the 430 MHz band and K type models use the 440 MHz band.
-

Frequency ranges:

- 118 MHz: 118 ~ 135.995 MHz
- 144 MHz: 136 ~ 199.995 MHz
- 220 MHz: 200 ~ 299.995 MHz
- 300 MHz: 300 ~ 399.995 MHz
- 430/440 MHz: 400 ~ 523.995 MHz
- 1200 MHz: 800 ~ 1299.995 MHz (excluding cellular band)

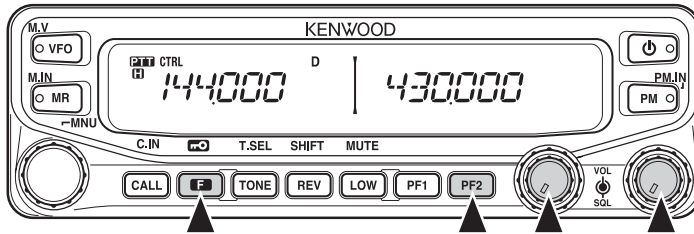

SELECTING AN OPERATING MODE

There are 3 operating modes available to choose from: VFO mode, Memory Channel mode, and Call Channel mode.

■ VFO Mode

VFO mode allows you to manually change the operating frequency.

- 1 Press **[VFO]** to enter VFO mode.

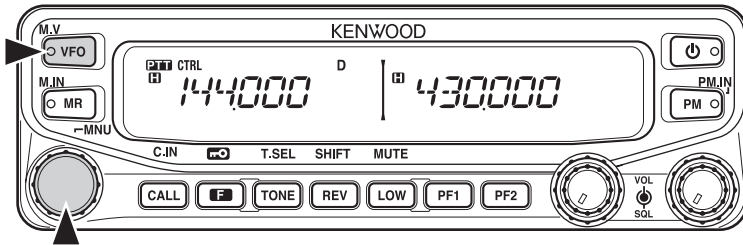

- 2 Rotate the **Tuning** control to select your desired operating frequency.
 - You can also adjust the frequency by using the microphone **[UP]/[DWN]** keys.
 - The default step frequency for the **Tuning** control varies according to the type and operating band:

Type	144 MHz	430/440 MHz
K	5 kHz	25 kHz
E	12.5 kHz	25 kHz
M4	10 kHz	10 kHz

- To adjust the frequency by a larger amount, you can press the **Tuning** control to enter MHz mode. While in MHz mode, rotate the **Tuning** control to adjust the frequency in steps of 1 MHz. Press the **Tuning** control again to exit MHz mode and adjust the frequency using the normal step frequency. Using the MCP-2A (Memory Control Program), you can set the MHz mode step frequency to 10 MHz. Pressing the **Tuning** control will switch between 10 MHz, 1MHz, and off.

■ Memory Channel Mode

Memory Channel mode allows you to quickly select a frequently used frequency and related data which you have saved in the transceiver memory.

- 1 Press **[MR]** to enter Memory Channel mode.

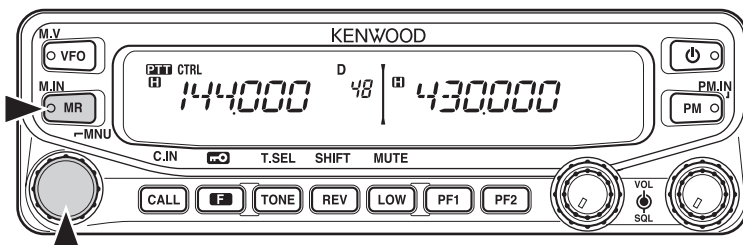

- 2 Rotate the **Tuning** control to select your desired Memory channel.

■ Call Channel Mode

Call Channel mode allows you to quickly select a preset channel to allow immediate calls on that frequency. The Call channel can be conveniently used as an emergency channel within your group.

- 1 Select your desired band (A or B).
 - The Call channel has a dedicated frequency for both bands A and B. The default frequency for band A is 144 MHz. The default frequency for band B is 430/440 MHz.
- 2 Press **[CALL]** to enter Call Channel mode.
 - “C” appears on the display.

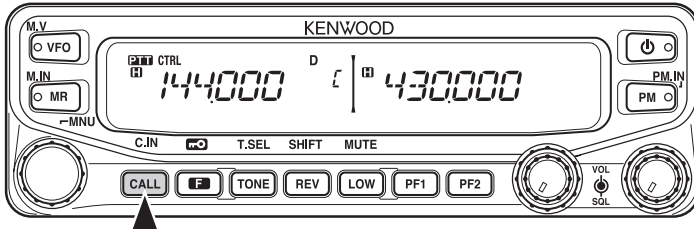

- 3 Press **[CALL]** again to return to your previous operating frequency.

TRANSMITTING

- 1 Select your desired band and frequency/channel.
- 2 Press and hold the microphone **[PTT]** switch and speak into the microphone to transmit.
 - The **ON AIR** icon and the RF power meter appear on the display for the selected transmit band. The RF power meter shows the relative transmit output power.
 - The **[H]** **[M]** **[L]** icon appears on the display, depending on what output power you have selected {page 70}.
 - Speak into the microphone in your normal voice, while keeping the microphone approximately 5 cm from your mouth. Speaking too close to the microphone or too loudly may increase distortion and reduce intelligibility of your signal at the receiving station.

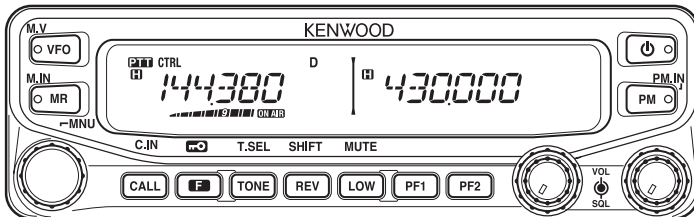

- 3 When you finish speaking, release the **[PTT]** switch.

MENU MODE

Many functions on this transceiver are selected or configured through the Menu instead of physical controls. Once you become familiar with the Menu system, you will appreciate the versatility it offers.

MENU ACCESS

- 1 Press **[F]**, **Tuning** control to access the Menu.
 - The Menu name and number appears on the display.



- 2 Rotate the **Tuning** control to select your desired Menu.
- 3 Press the **Tuning** control to set up the current Menu.

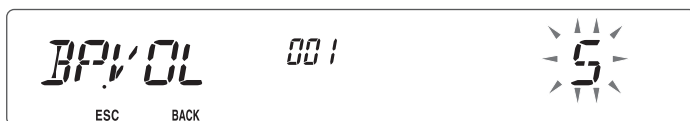

- 4 Rotate the **Tuning** control to select your desired value for the selected Menu.
- 5 Press the **Tuning** control to set the selected value.
- 6 Repeat steps 2 to 5 to set up additional Menus.
 - Press **[F]** (**ESC**) at any time to exit Menu mode.
 - Press **[TONE]** (**BACK**) at any time to cancel the Menu setup and return to the Menu selection.

MENU CONFIGURATION

Menu No.	Display	Description	Setting Values	Default Setting	Ref. Page
000	BEEP	Beep sound	OFF/ ON	ON	64
001	BP.VOL	Beep volume level	1 ~ 7	5	64
002	EXT.SP	External speaker output mode	MODE 1/ MODE 2	MODE 1	71
003 ¹	ANN	Voice announcement mode	OFF/ AUTO/ MANUAL	AUTO	75
004 ¹	ANN.LNG	Voice announcement language	ENG/ JPN	ENG	77
005 ¹	ANN.VOL	Voice announcement volume	1 ~ 7	5	77

Menu No.	Display	Description	Setting Values	Default Setting	Ref. Page
006 ¹	ANN.SPD	Voice announcement speed	0 ~ 4	1	77
007 ¹	PLAY.BK	Recording playback repeat	OFF/ ON	OFF	80
008 ¹	P.BK.INT	Playback repeat interval time	0 ~ 60 (seconds)	10	80
009 ¹	CON.REC	Conversation recording	OFF/ ON	OFF	79
100	PRG.VFO	Programmable VFO setup	Varies with the selected frequency band	–	64
101	STEP	Step frequency	Varies with the selected frequency band	–	65
102	MODLAT	Modulation/demodulation mode	Varies with the selected frequency band	–	69
103	VHF.AIP	VHF band AIP	OFF/ ON	OFF	68
104	UHF.AIP	UHF band AIP	OFF/ ON	OFF	68
105	S.SQL	S-meter squelch	OFF/ ON	OFF	68
106	S.SQ.HNG	S-meter squelch hangup time	OFF/ 125/ 250/ 500 (ms)	OFF	68
107	MUT.HNG	Mute hangup time setup	OFF/ 125/ 250/ 500/ 750/ 1000 (ms)	OFF	70
108	B.SHIFT	Beat shift	OFF/ ON	OFF	69
109	TOT	Time-out timer	3/ 5/ 10 (minutes)	10	70
110 ²	WX.ALT	Weather alert	OFF/ ON	OFF	73
200 ³	M.NAME	Memory name setup	Up to 6 characters	–	35
201	RECALL	Memory channel recall method	ALL/ CURRENT	ALL	34
202 ³	L.OUT	Memory channel lockout	OFF/ ON	OFF	44
203	GR.LINK	Memory group link registration	Up to 10 digits (0 ~ 9)	–	45
204	ELK.MEM	EchoLink memory setting	Up to 8 digits for DTMF code	–	59
205	ELK.SPD	EchoLink memory transmission speed	FAST/ SLOW	FAST	60
300	DT.HOLD	DTMF transmission hold	OFF/ ON	OFF	55
301	DT.MEM	DTMF memory	Up to 16 cdigits for DTMF code	–	56

Menu No.	Display	Description	Setting Values	Default Setting	Ref. Page
302	DT.SPD	DTMF memory transmission speed	FAST/ SLOW	FAST	57
303	DT.PAUS	DTMF pause code time	100/ 250/ 500/ 750/ 1000/ 1500/ 2000 (ms)	500	58
304	DT.LOCK	DTMF key lock	OFF/ ON	OFF	58
400	OFFSET	Offset frequency	See reference page	–	27
401 ⁴	ARO	Auto Repeater Offset	OFF/ ON	ON	29
402	1750.HD	Transmission hold when transmitting a 1750 Hz tone	OFF/ ON	OFF	30
403 ²	RPT.MOD	Repeater mode	CROSS/ A-TX/ B-TX	CROSS	81
404 ²	RPT.HLD	Repeater transmission hold	ON/ OFF	OFF	82
405 ²	RPT.ID	Repeater ID registration	Up to 6 characters	–	82
406 ²	ID.TX	Repeater ID transmission	OFF/ MORSE/ VOICE	OFF	82
500	P.ON.MSG	Power on message setup	Up to 6 characters	HELLO	62
501	BRIGHT	Display brightness	OFF/ 1 ~ 8	8	62
502	AUTO.BR	Display auto brightness	OFF/ ON	OFF	62
503	COLOR	Backlight color	AMBER/ GREEN	AMBER	63
507	PF1	PF1 key programmable function value	See reference page	FR.BAND	66
508	PF2	PF2 key programmable function value	See reference page	CTRL	66
509	MIC.PF1	Microphone PF1 key programmable function value	See reference page	A/B	66
510	MIC.PF2	Microphone PF2 key programmable function value	See reference page	MR	66
511	MIC.PF3	Microphone PF3 key programmable function value	See reference page	VFO	66
512	MIC.PF4	Microphone PF4 key programmable function value	See reference page	CALL (K/ M4 types) 1750 (E types)	66

Menu No.	Display	Description	Setting Values	Default Setting	Ref. Page
513	MIC.LCK	Microphone key lock	OFF/ ON	OFF	63
514	SC.RESM	Scan resume method	TO/ CO/ SEEK	TO	43
516	APO	Auto Power Off time	OFF/ 30/ 60/ 90/ 120/ 180 (minutes)	180	67
517	DAT.BND	Data Band mode	A/ B/ ATX.BRX/ ARX.BTX	A	83
518	DAT.SPD	Data communications speed	1200/ 9600 (bps)	1200	83
519	PC .SPD	PC terminal baud rate speed	9600/ 19200/ 38400/ 57600 (bps)	9600	84
520	SQC.SRC	SQC output type	OFF/ BUSY/ SQL/ TX/ BUSY.TX/ SQL.TX	BUSY.TX	84
521	AUTO.PM	Automatic PM entry	OFF/ ON	ON	41
522 ²	REM.ID	Personal Identificaton Number	000 ~ 999	000	85
523 ²	ANS.BK	Answer back	OFF/ ON	ON	85
527	DP.BAR	Display partition bar	OFF/ ON	ON	72
998	PASSWD	Power on password	OFF/ ON	OFF	74
999	RESET	Reset	VFO/ PART/ PM/ FULL	VFO	88

¹ Menu numbers 03 ~ 09 are available only when the optional VGS-1 unit is installed in the transceiver.

² Menu numbers 110, 403 ~ 406, 522, and 523 are available only for K type models.

³ Menu numbers 200 and 202 are available only if a Memory Channel has been stored in the transceiver.

⁴ Menu number 401 is available only for K and E type models.

CHARACTER ENTRY

Certain menus require you to enter characters, such as the power on message and memory names. When character entry is required, a cursor will appear on the display.

1 Press the **Tuning** control.

- The cursor will blink.



2 Rotate the **Tuning** control to select your desired character.

- You can enter characters as described below:
 - Power on message, memory name, and repeater ID (K type only): 0 ~ 9, A ~ Z, -, /, @, and space
 - DTMF memory code: 0 ~ 9, A ~ F, and space
 - EchoLink memory code: 0 ~ 9, A ~ F
 - Memory group link and wireless remote ID (K type only): 0 ~ 9

3 Press the **Tuning** control to set the selected character.

- The cursor will move to the next digit.

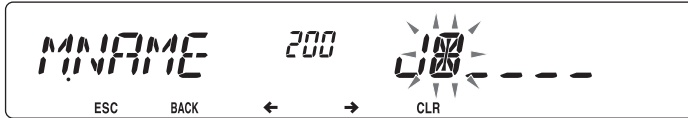

- You can move the cursor to the left or right by pressing **[REV]** (←) or **[LOW]** (→).
- You can delete the selected character by pressing **[PF1]** (CLR).

4 Repeat steps 2 and 3 to enter the remaining characters.

- Press **[F]** (ESC) at any time to exit Menu mode.
- Press **[TONE]** (BACK) at any time to cancel the Menu setup and return to the Menu selection.

■ Microphone Keypad Character Entry

The microphone keys can also be used to enter characters. Refer to the table below for characters corresponding to microphone keys.

Key	Character Display (with each press of the key)			
1	Q	Z	1	
2	A	B	C	2
3	D	E	F	3
4	G	H	I	4
5	J	K	L	5
6	M	N	O	6
7	P	R	S	7
8	T	U	V	8
9	W	X	Y	9
0	(space)	0		
*	Not used			
#	-	/	@	

The microphone **[A]** ~ **[D]** keys have special functions assigned to them:

[A]: Functions the same as **[PF1] (CLR)**

[B]: Functions the same as **[REV] (←)**

[C]: Functions the same as **[LOW] (→)**

[D]: Functions the same as the **Tuning** control

OPERATING THROUGH REPEATERS

Repeaters are often installed and maintained by radio clubs, sometimes with the cooperation of local businesses involved in the communications industry.

Compared to simplex communication, you can usually transmit over much greater distances by using a repeater. Repeaters are typically located on mountain tops or other elevated locations. They generally operate at higher ERP (Effective Radiated Power) than a typical station. This combination of elevation and high ERP allows communications over considerable distances.

TX: 144.725 MHz
TX tone: 88.5 Hz
RX: 145.325 MHz

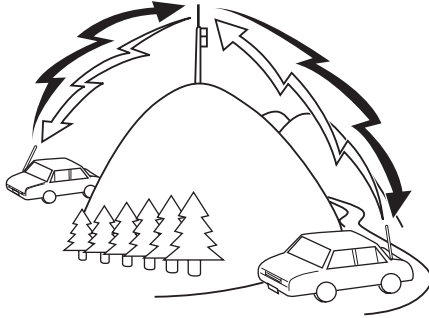

TX: 144.725 MHz
TX tone: 88.5 Hz
RX: 145.325 MHz

REPEATER ACCESS

Most repeaters use a receive and transmit frequency pair with a standard or non-standard offset (odd-split). In addition, some repeaters must receive a tone from the transceiver in order to gain access to the repeater. For details, consult your local repeater reference.

■ Selecting an Offset Direction

The offset direction allows your transmit frequency to be higher (+) or lower (-) than the receive frequency.

- 1 Select your desired band (A or B).
- 2 Press **[F]**, **[REV]** to select an offset direction.
 - Each time you press **[F]**, **[REV]**, the offset direction changes as follows:

Simplex operation >> + >> - >> Simplex operation

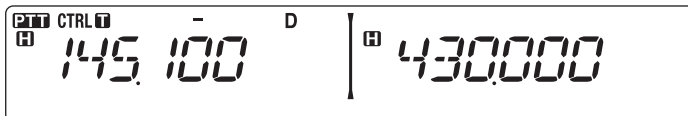
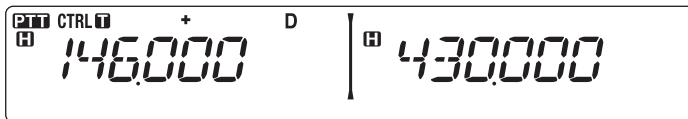

- If you are using an E type transceiver, when operating on the 430 MHz band, the offset direction changes as follows:

Simplex operation >> + >> - >> = (-7.6 MHz) >> Simplex operation

If the offset transmit frequency falls outside the allowable range, transmitting is inhibited. Use one of the following methods to bring the transmit frequency within the band limits:

- Move the receive frequency further inside the band.
- Change the offset direction.

Note: While using an odd-split memory channel or transmitting, you cannot change the offset direction.

■ Selecting an Offset Frequency

The offset frequency is the value which the transmit frequency will be offset from the receive frequency. The default offset frequency on the 144 MHz band is 600 kHz for all type versions. The default on the 430/440 MHz band is 5 MHz.

- 1 Select your desired band (A or B).
- 2 Enter Menu mode and access Menu 400 (OFFSET) {page 20}.



- 3 Set the appropriate offset frequency value.
 - The selectable range is from 00.00 MHz to 29.95 MHz, in steps of 50 kHz.

Note: After changing the offset frequency, the new offset frequency will also be used by Automatic Repeater Offset {page 29}.

■ Activating the Tone Function

To turn the Tone function on:

- 1 Select your desired band (A or B).
- 2 Press [TONE] to turn the Tone function ON.
 - Each time you press [TONE], the selection changes as follows: None >> T (Tone) >> CT (CTCSS) >> DCS (DCS) >> None
 - The  icon appears on the display when the tone function is ON.

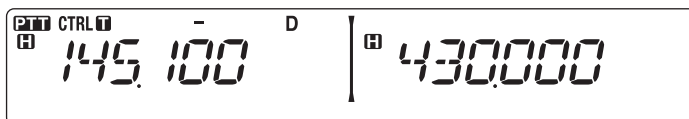

Note: When accessing a repeater that requires a 1750 Hz tone, you do not need to activate the Tone function. Simply press the key assigned to the 1750 Hz tone {page 66} to transmit the tone.

■ Selecting a Tone Frequency

To select the tone frequency required to access your desired repeater:

- 1 Turn the Tone function ON.
- 2 Press **[F]**, **[TONE]**.
 - The current tone frequency appears on the display. The default frequency is 88.5 Hz.

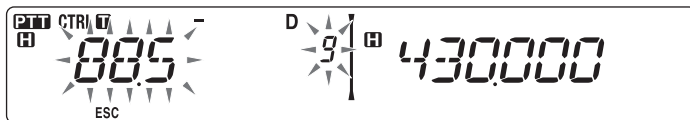

- 3 Rotate the **Tuning** control to select your desired frequency.
 - To exit the tone frequency selection, press **[F]** (**ESC**).
- 4 Press any key other than the **Tuning** control and **[F]** (**ESC**) to set the selected frequency.

Note: If you have set up a Memory channel with a tone setting, simply recall the Memory channel instead of setting up the tone frequency every time.

No.	Frequency (Hz)	No.	Frequency (Hz)	No.	Frequency (Hz)	No.	Frequency (Hz)
01	67.0	12	97.4	23	141.3	34	206.5
02	69.3	13	100.0	24	146.2	35	210.7
03	71.9	14	103.5	25	151.4	36	218.1
04	74.4	15	107.2	26	156.7	37	225.7
05	77.0	16	110.9	27	162.2	38	229.1
06	79.7	17	114.8	28	167.9	39	233.6
07	82.5	18	118.8	29	173.8	40	241.8
08	85.4	19	123.0	30	179.9	41	250.3
09	88.5	20	127.3	31	186.2	42	254.1
10	91.5	21	131.8	32	192.8		
11	94.8	22	136.5	33	203.5		

■ Automatic Repeater Offset (K and E Types Only)

This function automatically selects an offset direction and activates the Tone function, according to the frequency that you have selected. To obtain an up-to-date band plan for repeater offset direction, contact your national Amateur Radio association.

- 1 Enter Menu mode and access Menu 401 (ARO) {page 20}.
- 2 Set the ARO to ON.

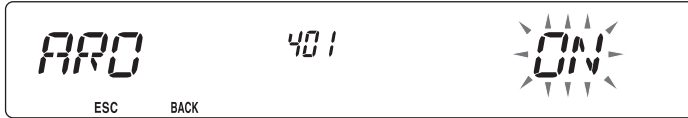

- 3 Press **[BAND SEL A]** to select the A band.
- 4 Press **[VFO]** to select VFO mode.
- 5 Rotate the **Tuning** control to select your desired frequency.

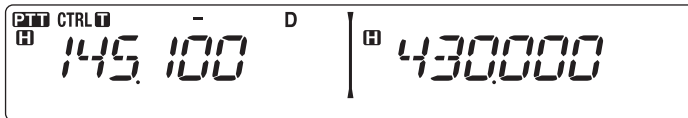

- 6 Press **[PTT]** to start a call.
 - You will be transmitting on an offset frequency value determined from your offset setting value {page 27} and an offset direction depending on your selected frequency. Refer to the settings below for offset directions:

K Type:

- Under 145.100 MHz: No offset (Simplex operation)
- 145.100 ~ 145.499 MHz: Minus (-) offset
- 145.500 ~ 145.999 MHz: No offset (Simplex operation)
- 146.000 ~ 146.399 MHz: Plus (+) offset
- 146.400 ~ 146.599 MHz: No offset (Simplex operation)
- 146.600 ~ 146.999 MHz: Minus (-) offset
- 147.000 ~ 147.399 MHz: Plus (+) offset
- 147.400 ~ 147.599 MHz: No offset (Simplex operation)
- 147.600 ~ 147.999 MHz: Minus (-) offset
- 148.000 MHz and higher: No offset (Simplex operation)

E Type:

- Under 145.000 MHz: No offset (Simplex operation)
- 145.600 ~ 145.799 MHz: Minus (-) offset
- 145.800 MHz and higher: No offset (Simplex operation)

TRANSMITTING A 1750 Hz TONE

Most repeaters in Europe require that a transceiver transmit a 1750 Hz tone. By turning the 1750 Hz tone menu item ON, the transceiver will automatically transmit the 1750 Hz tone for 2 seconds whenever you transmit.

- 1 Enter Menu mode and access Menu 402 (1750.HD) {page 20}.

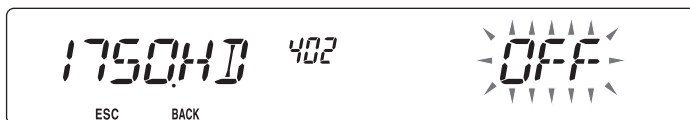

- 2 Set the tone to ON or OFF.

- When set to ON, the 1750 Hz tone will transmit. When set to OFF, the tone will not be transmitted.

REVERSE FUNCTION

After setting a separate receive and transmit frequency, you can exchange these frequencies using the Reverse function. This allows you to manually check the strength of signals you receive directly from other stations, while using a repeater. If the station's signal is strong, move to a simplex frequency to continue the contact and free up the repeater.

Press **[REV]** to turn the Reverse function ON or OFF.

- When the Reverse function is ON, the R icon will appear on the display.

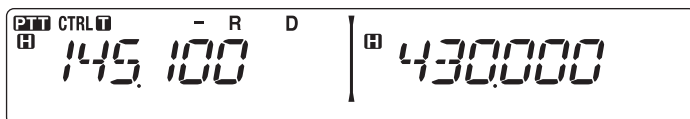

Note:

- ◆ If the transmit frequency is outside the allowable transmit frequency range when using Reverse, pressing **[PTT]** will cause an error tone to sound and transmission will be inhibited.
- ◆ If the receive frequency is outside the receive frequency range when using Reverse, an error tone will sound and Reverse will not operate.
- ◆ The ARO (Automatic Repeater Offset) will not function when Reverse is ON.
- ◆ You cannot switch Reverse ON or OFF while transmitting.

AUTOMATIC SIMPLEX CHECKER (ASC)

While using a repeater, ASC periodically monitors the strength of signals you receive directly from the other stations. If the station's signal is strong enough to allow direct contact without a repeater, the  icon blinks.

Press **[REV] (1s)** to turn the ASC ON.

- When the ASC is ON, the  icon will appear on the display.

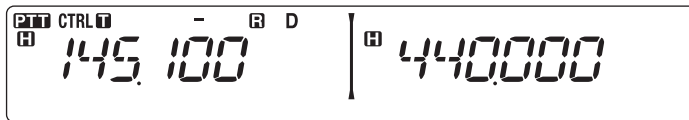



- While direct contact is possible, without the use of a repeater, the  icon will begin blinking.
- To exit ASC, press **[REV]**.

Note:

- ◆ Pressing **[PTT]** will cause the  icon to stop blinking.
- ◆ ASC does not function if you are using simplex operation.
- ◆ ASC does not function while scanning.
- ◆ Activating ASC while using Reverse will switch the Reverse function OFF.
- ◆ If you recall a Memory channel or the Call channel, and those channels are set up with the Reverse function switched ON, the ASC will switch OFF.
- ◆ ASC causes received signals to be momentarily intermitted every 3 seconds.

TONE FREQUENCY ID

This function scans through all tone frequencies to identify the incoming tone frequency on a received signal. You can use this function to find which tone frequency is required by your local repeater.

- 1 Press **[TONE]** to switch the Tone function ON.
 - The  icon appears on the display.
- 2 Press **[F]**, **[TONE]** (1s) to run the Tone Frequency ID scan.
 - The  icon blinks and SCAN appears on the display.

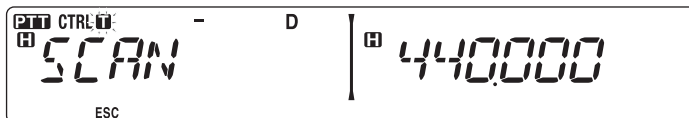

- To reverse the scan direction, turn the **Tuning** control clockwise (upward scan) or counterclockwise (downward scan).
- To quit the function, press **[F]** (**ESC**).
- When the tone frequency is identified, the identified frequency appears on the display and blinks. Press any key other than the **Tuning** control while the identified frequency is blinking, to resume scanning.

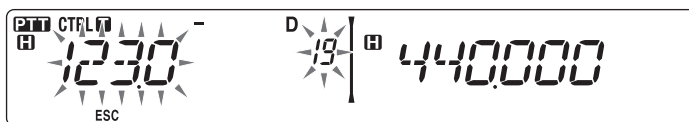

- 3 Press the **Tuning** control to program the identified frequency in place of the currently set tone frequency.
 - The Tone function will remain ON. You can press **[TONE]** to switch the Tone function OFF.
 - Press **[F]** (**ESC**) if you do not want to program the identified frequency.

MEMORY CHANNELS

In Memory channels, you can store frequencies and related data that you often use. Then you need not reprogram the data every time. You can quickly recall a programmed channel by simple operation. A total of 1000 Memory channels are available for bands A and B.

SIMPLEX & REPEATER OR ODD-SPLIT MEMORY CHANNEL?

You can use each memory channel as a simplex & repeater channel or as an odd-split channel. Store only one frequency to use as a simplex & repeater channel or two separate frequencies to use as an odd-split channel. Select either application for each channel depending on the operations you have in mind.

Simplex & repeater channels allow:

- Simplex frequency operation
- Repeater operation with a standard offset (if an offset direction is stored)

Odd-split channels allow:

- Repeater operation with a non-standard offset

The data listed below can be stored in each Memory channel:

Parameter	Simplex & Repeater	Odd-split
Receive frequency	Yes	Yes
Transmit frequency		Yes
Receive frequency step size	Yes	Yes
Transmit frequency step size		Yes
Offset direction	Yes	No
Tone ON/OFF	Yes	Yes
Tone frequency	Yes	Yes
CTCSS ON/OFF	Yes	Yes
CTCSS frequency	Yes	Yes
DCS ON/OFF	Yes	Yes
DCS code	Yes	Yes
Reverse ON/OFF	Yes	No
Memory channel lockout	Yes	Yes
Memory channel name	Yes	Yes
Modulation/Demodulation mode	Yes	Yes

STORING SIMPLEX AND STANDARD REPEATER FREQUENCIES

- 1 Press **[VFO]** to enter VFO mode.
- 2 Rotate the **Tuning** control to select your desired frequency.
 - Additionally, you can press the microphone **[UP]/[DWN]** keys to select a frequency.
- 3 Set up any additional data desired for the frequency.
 - Offset direction, Tone ON/OFF, Tone frequency, CTCSS ON/OFF, CTCSS frequency, DCS ON/OFF, DCS code, etc.
- 4 Press **[F]**.
 - A memory channel number appears.

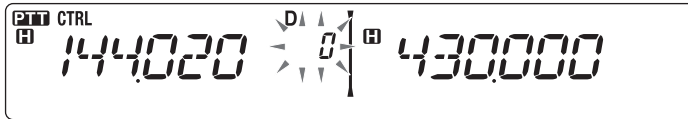

- 5 Rotate the **Tuning** control to select your desired channel number.
 - Additionally, you can press the microphone **[UP]/[DWN]** keys to select a channel.
- 6 Press **[MR]** to store the data in the selected Memory channel.

Note: If you store the data in a Memory channel that already has data stored in it, the old data will be cleared and the new data will be stored.

■ Call Channel Memory (Simplex)

The Call channel can be used to store any frequency and related data that you will recall often. You may want to dedicate the Call channel as an emergency channel within your group.

To store a simplex frequency and related data as the Call channel instead of in a Memory channel, after step 4 (above), press **[CALL]**.

Note: Storing new data in the Call channel will clear the old data. (The Call channel itself cannot be cleared, but data can be replaced with new data.)

STORING ODD-SPLIT REPEATER FREQUENCIES

Some repeaters use a receive and transmit frequency pair with a non-standard offset. To access those repeaters, store two separate frequencies in a memory channel. You can then operate on those repeaters without changing the offset frequency you stored in the menu.

- 1 Set up a simplex channel by following steps 1 to 6 of “STORING SIMPLEX AND STANDARD REPEATER FREQUENCIES”, above.
- 2 Press **[VFO]** to enter VFO mode.
- 3 Rotate the **Tuning** control to select your desired transmit frequency.
 - Additionally, you can press the microphone **[UP]/[DWN]** keys to select a frequency.

- 4 Set up any additional data desired for the transmit frequency.
 - Tone ON/OFF, Tone frequency, CTCSS ON/OFF, CTCSS frequency, DCS ON/OFF, DCS code, etc.
- 5 Press **[F]**.
 - A memory channel number appears.
- 6 Rotate the **Tuning** control to select your desired channel number.
 - Additionally, you can press the microphone **[UP]/[DWN]** keys to select a channel.

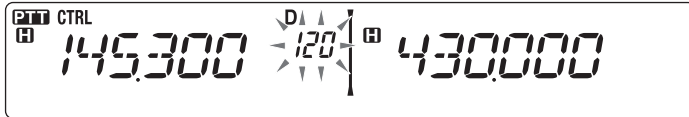

- 7 Press **[PTT]**, **[MR]** to store the data in the selected Memory channel.

■ Call Channel Memory (Odd-Split)

The Call channel can be used to store any frequency and related data that you will recall often. You may want to dedicate the Call channel as an emergency channel within your group.

To store an odd-split frequency and related data as the Call channel instead of in a Memory channel, after step 6 (above), press **[PTT]**, **[CALL]**.

Note: You cannot store the transmit offset status and Reverse status in an odd-split Call channel.

RECALLING A MEMORY CHANNEL

- 1 Press **[MR]** to enter Memory Recall mode.
- 2 Rotate the **Tuning** control to select your desired Memory channel.
 - Additionally, you can press the microphone **[UP]/[DWN]** keys to select a channel, or you can enter a channel number using the microphone keypad.

■ Memory Recall Method

The transceiver Menu also provides you with the option to recall Memory channels with stored frequencies in your current band, or all Memory channels:

- 1 Enter Menu mode and access Menu 201 (RECALL) {page 20}.



- 2 Set the recall method to CURENT (current band) or ALL (all bands).
 - CURENT allows you to recall only those memory channels that have stored frequencies within the current band {page 17}. ALL allows you to recall all programmed memory channels.
 - When the recalled memory channel is an AM channel, you cannot recall on the B band.

CLEARING A MEMORY CHANNEL

- 1 Press **[MR]** to enter Memory Recall mode.
- 2 Rotate the **Tuning** control to select your desired Memory channel.
 - Additionally, you can press the microphone **[UP]/[DOWN]** keys to select a channel, or you can enter a channel number using the microphone keypad.

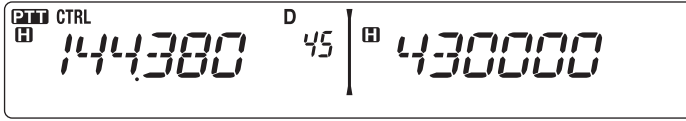

- 3 Turn the transceiver power OFF.
- 4 Press **[MR] + Power ON**.
 - A confirmation message appears on the display.



- 5 Press the **Tuning** control to clear the Memory channel.
 - To exit without clearing the channel, press **[F] (ESC)**.

NAMING A MEMORY CHANNEL

You can name Memory channels using up to 6 alphanumeric characters. When you recall a named Memory channel, its name appears on the display instead of the stored frequency. Names can be call signs, repeater names, cities, people, etc.

- 1 Press **[MR]** to enter Memory Recall mode.
- 2 Rotate the **Tuning** control to select your desired Memory channel.
- 3 Enter Menu mode and access Menu 200 (M.NAME) {page 20}.



- 4 Enter your desired name for the channel {page 24}.

Note: You can overwrite a Memory channel name by performing the steps above. You can also clear a Memory channel name by clearing the Memory channel.

SWITCHING THE MEMORY NAME/ FREQUENCY DISPLAY

After storing memory names, you can switch the display between the memory name and the stored frequency. This can be useful if you need to confirm the frequency stored in named Memory channels.

- 1 Press **[MR]** to enter Memory Recall mode.
- 2 Press the **Tuning** control to toggle between the memory name and the stored frequency.

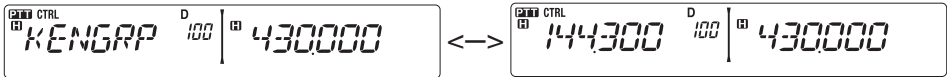

MEMORY-TO-VFO TRANSFER

Transferring the contents of a Memory channel or the Call channel to the VFO can be useful if you want to search for other stations or a clear frequency, near the selected Memory channel or Call channel frequency.

- 1 Press **[MR]** or **[CALL]** to enter Memory Recall mode or select the Call channel.
- 2 Rotate the **Tuning** control to select your desired channel. (This step is not necessary when selecting the Call channel.)
- 3 Press **[F]**, **[VFO]**.
 - The entire contents of the Memory channel or Call channel are copied to the VFO, and VFO mode is selected after the transfer is complete.
 - When copying a transmit frequency from an odd-split Memory or Call channel, you must first turn the Reverse function ON before pressing **[F]**, **[VFO]**.

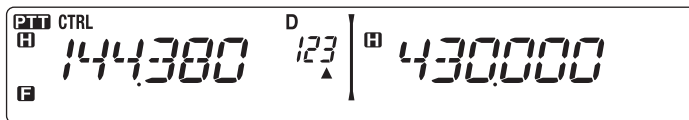

CHANNEL DISPLAY FUNCTION

Use this function when you want to use only Memory channels. When this function is switched ON, the transceiver displays only a Memory channel number instead of a frequency.

- 1 Turn the transceiver power OFF.
- 2 Press **[LOW] + Power ON** to turn the channel display ON or OFF.

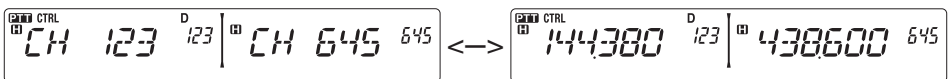

Note:

- ◆ If no Memory channels have saved data in them, channel display will not function.
- ◆ If a channel has a stored name, the name will appear on the display in place of the channel number.
- ◆ When using Channel Display, you cannot reset the transceiver.

While in Channel Display mode, the transceiver keys function as shown below:

Key Name	[KEY]	[F], [KEY]	[KEY] (1s)	While Transmitting	[KEY] + Power ON
	Power ON/ OFF	Power ON/ OFF	Power ON/ OFF	Power ON/ OFF	X
PM	–	–	–	–	–
VFO	–	–	–	–	–
MR	MR mode	–	Memory Scan	–	–
CALL	Call mode	Store in Call channel	Call Scan	–	–
F	Function mode	Exit Function mode	Key Lock	–	–
TONE	–	–	–	–	–
REV	Reverse ON/OFF	–	–	–	–
LOW	Change output power	Mute	–	Change output power	Change channel display
PF1	Select the Weather channel (K type)	–	–	–	–
PF2	Change control band	–	–	–	–
Tuning control	Change between the CH number and the channel name	–	Group Scan	–	–
BAND SEL A	A band	–	Change Single/Dual	–	–
BAND SEL B	B band	–	Change Single/Dual	–	–

PROGRAMMABLE MEMORY (PM)

Programmable Memory (PM) stores virtually all settings currently set on the transceiver. This transceiver provides 5 PM channels to store 5 sets of transceiver configurations. Later, you can quickly recall any one of these channels, depending on the operations you have in mind or the operating environment.

The following programmable settings cannot be stored:

- Memory name
- Memory channel lockout
- Channel Display mode
- Locked-band/ Cross-band Repeater ON/OFF ¹
- Repeater mode ¹
- Repeater hold ¹
- Repeater ID transmit ¹
- Registered repeater ID ¹
- Wireless remote control ¹
- Answer back ¹
- Remote control ID ¹
- Key lock
- Power on password ²
- Memory channel/ Call channel/ Program scan memory
- Weather channel ¹
- DTMF memory
- EchoLink memory
- PC port speed
- 10 MHz mode ²
- Mic sensitivity ²
- SQC data output logic ²

¹ K type only

² Can be set only by using the MCP-2A software.

APPLICATION EXAMPLES

The following are examples of how you might use Programmable Memory. These examples may not represent applications useful to you, but you will understand the flexibility of this function.

Situation: You share your transceiver with other members in your family or club. However, each individual has personal preferences for how they like to set various functions. You have to keep changing many settings each time you use the transceiver.

Solution: Because 5 PM channels are available, up to 5 persons can separately program the transceiver and store their customized environment. Then each person can quickly change to his or her favorite settings, simply by recalling a PM channel. It is too much trouble to change back the settings after somebody else has reconfigured them. So this application may avoid having a feature-rich transceiver but never using many useful features.

Situation: While operating mobile on the way to work every morning, you prefer a silent transceiver that does not interrupt the morning calm. In addition, you feel that a bright display is useless in the sunlight. At night when driving home, you realize the Beep function truly does serve a purpose and you acknowledge it is nice to see a bright display after dark.

Solution: In 2 PM channels, store the same operating data such as frequency, offset, tone, etcl, and store different settings for the Display brightness and Beep functions. Then you can quickly recall the best settings for day or night operation.

Situation: You cannot figure out how to exit the current transceiver mode.

Solution: Simply recall PM channel 1, which contains an exact copy of the transceiver default environment. You will not lose the contents of any memory channels.

STORING DATA IN PM CHANNELS

- 1 Confirm that the following conditions have been satisfied:
 - The transceiver is in receive mode.
 - Scan is not being used.
 - Microphone Control is OFF.
- 2 Configure the transceiver with your desired settings.
- 3 Press **[F]**, **[PM]**.
 - PM channel numbers 1 to 5 appear and blink at the bottom of the display.

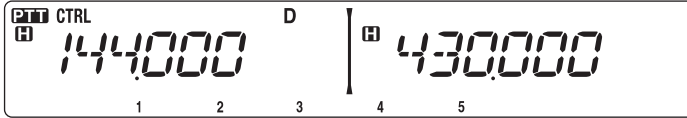

- 4 Enter a channel number (**[1]** to **[5]**) corresponding to your desired PM channel.
 - The settings are stored in the PM channel.

RECALLING PM CHANNELS

- 1 Press **[PM]**.
 - PM channel numbers 1 to 5 and OFF appear on the bottom of the display.

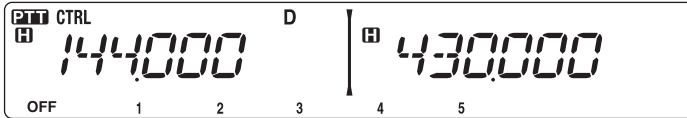

- 2 Enter a channel number (**[1]** to **[5]**) corresponding to your desired PM channel.
 - The settings stored in the PM channel are recalled.
 - The selected channel number appears on the display.
 - When selecting **[OFF]**, the PM channels turn off.

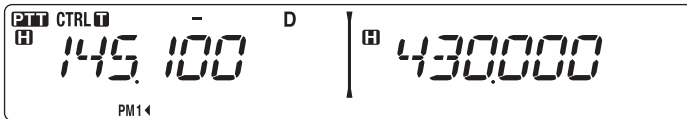

AUTO PM CHANNEL STORE

After you recall a PM channel, this function automatically overwrites the current PM channel with the present operating environment when:

- You recall another PM channel.
- You press **[PM]**.
- You switch the transceiver power OFF.

Follow the steps below to activate the Auto PM storage function.

- 1 Enter Menu mode and access Menu 521 (AUTO.PM) {page 20}.



- 2 Set AUTO.PM to ON.

PM CHANNEL RESET

To reset the PM channels to their default settings:

- 1 Turn the transceiver power OFF.
- 2 Press **[F] + Power ON**.
- 3 Release **[F]**.
- 4 Rotate the **Tuning** control and select PM.



- 5 Press the **Tuning** control.
 - A confirmation message appears on the display.



- 6 Press the **Tuning** control again to reset the PM channels.
 - Press **[TONE] (BACK)** to return to the previous display.
 - To exit without resetting the PM channels, press **[F] (ESC)**.

SCAN

Scan is a useful feature for hands-off monitoring of your favorite frequencies. Becoming comfortable with all types of Scan will increase your operating efficiency.

This transceiver provides the following types of scans:

Scan Type	Scan Range
VFO Scan	Scans all frequencies on the current band.
Memory Scan	Scans all frequencies stored in the Memory channels.
Group Scan	Scans the frequencies in the Memory channels which belong to the group you have specified.
Program Scan	Scans all frequencies within the programmed range, on the current band.
MHz Scan	Scans all frequencies within a 1 MHz range from the originating frequency.
Call Scan	Scans the Call channel as well as the currently selected VFO frequency or Memory channel.

Note:

- ◆ Adjust the squelch level before using Scan. Selecting a squelch level too low could cause Scan to stop immediately.
 - ◆ While using CTCSS or DCS, Scan stops for any signal received; however, you will hear audio only when the signal contains the same CTCSS tone or DCS code that you selected.
 - ◆ When using S-meter Squelch, Scan stops when the received signal strength matches or exceeds the S-meter setting. Scan resumes 2 seconds after the signal level drops below the S-meter setting.
 - ◆ Pressing and holding **[PTT]** causes Scan to temporarily stop if it is functioning on a non TX band.
 - ◆ Starting Scan switches the Automatic Simplex Checker OFF.
-

SELECTING A SCAN RESUME METHOD

The transceiver stops scanning at a frequency or Memory channel on which a signal is detected. It then continues scanning according to which resume mode you have selected. You can choose one of the following modes. The default is Time-operated mode.

- **Time-Operated mode**

The transceiver remains on a busy frequency or Memory channel for approximately 5 seconds, and then continues to scan even if the signal is still present.

- **Carrier-Operated mode**

The transceiver remains on a busy frequency or Memory channel until the signal drops out. There is a 2 second delay between signal drop-out and scan resumption.

- **Seek mode**

The transceiver remains on a busy frequency or Memory channel even after the signal drops out and does not automatically resume scanning.

Note: To temporarily stop scanning and monitor weak signals, press the microphone PF key assigned to the Monitor function {page 66}. Press the PF key again to resume scanning.

- 1 Enter Menu mode and access Menu 514 (SC.RESM) {page 20}.

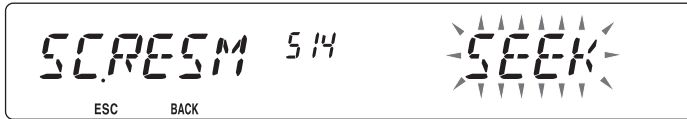

- 2 Set the Scan Resume mode to TO (Time-Operated), CO (Carrier-Operated) or SEEK.

VFO SCAN

VFO Scan monitors all frequencies tunable on the band, using the current frequency step size.

- 1 Select your desired band.

- 2 Press **[VFO] (1s)**.

- Scan starts at the current frequency.
- The 1 MHz decimal blinks while scanning is in progress.
- To reverse the scan direction, turn the **Tuning** control clockwise (upward scan) or counterclockwise (downward scan). You can also press microphone **[UP]/ [DWN]**.

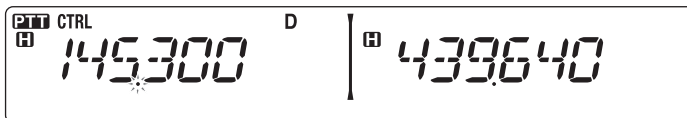

- 3 To quit VFO Scan, press **[VFO]** again.

MEMORY SCAN

Use Memory Scan to monitor all Memory channels programmed with frequency data.

- 1 Select your desired band.
- 2 Press **[MR]** (1s).
 - Scan starts at the current frequency.
 - The 1 MHz decimal blinks while scanning is in progress.
 - To reverse the scan direction, turn the **Tuning** control clockwise (upward scan) or counterclockwise (downward scan). You can also press microphone **[UP]**/ **[DWN]**.
- 3 To quit Memory Scan, press **[MR]** again.

Note:

- ◆ At least 2 Memory channels must contain data and must not be locked out of scan.
 - ◆ The L0/U0 to L9/U9 Memory channels will not be scanned.
 - ◆ You can also start Memory Scan when in Channel Display mode. While Scan is paused on a channel, the channel number blinks.
-

■ Locking Out a Memory Channel

You can select Memory channels that you prefer not to monitor while scanning.

- 1 Press **[MR]**, then rotate the **Tuning** control to select your desired channel.
- 2 Enter Menu mode and access Menu 202 (L.OUT) {page 20}.



- 3 Set the lockout to ON to lock the channel out of the scanning sequence.
 - To cancel lockout, set the lockout to OFF.
 - The ★ icon appears on the display for a channel that has been locked out.

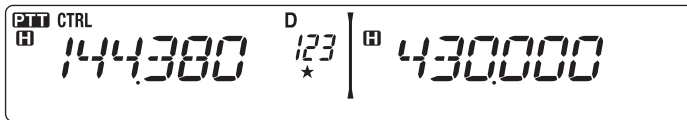

Note: The L0/U0 to L9/U9 Memory channels cannot be locked out.

GROUP SCAN

For the purpose of Group Scan, the 1000 Memory channels are divided into 10 groups, with each group containing 100 channels. Group Scan monitors only the 100 channels which belong to the specific group you are scanning. The channels are grouped as follows:

Memory Group	Channel Range	Memory Group	Channel Range
0	0 ~ 99	5	500 ~ 599
1	100 ~ 199	6	600 ~ 699
2	200 ~ 299	7	700 ~ 799
3	300 ~ 399	8	800 ~ 899
4	400 ~ 499	9	900 ~ 999

- 1 Press **[MR]**, then rotate the **Tuning** control to select a channel in your desired group.
- 2 Press the **Tuning** control (1s).
 - Scan starts at the current channel.
 - The 1 MHz decimal blinks while scanning is in progress.
 - To reverse the scan direction, turn the **Tuning** control clockwise (upward scan) or counterclockwise (downward scan). You can also press microphone **[UP]/ [DWN]**.
- 3 To quit Group Scan, press the **Tuning** control again.

Note:

- ◆ At least 2 Memory channels in the selected group must contain data and must not be locked out of scan.
 - ◆ You can also start Memory Scan when in Channel Display mode. While Scan is paused on a channel, the channel number blinks.
-

■ Memory Group Link

Memory Group Link provides you with the ability to link 2 or more Memory channel groups together to act as a single group when scanning. You can link up to 6 separate groups together, or even add multiple instances of the same group to the group link, to ensure that one group is scanned more often than the other groups.

- 1 Enter Menu mode and access Menu 203 (GR.LINK) {page 20}.
- 2 Press the **Tuning** control.
 - The cursor will begin blinking.



- 3 Rotate the **Tuning** control to select a group to link.
- 4 Press the **Tuning** control to set the group and move the cursor to the right.
 - Press **[REV]** (←) to move the cursor back or **[LOW]** (→) to move the cursor to the right.
- 5 Repeat steps 3 and 4 to link additional groups together.

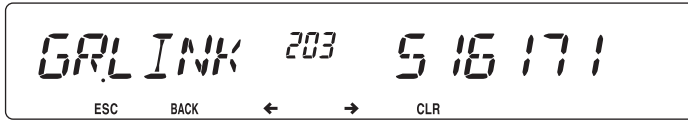

- 6 When you have entered your desired groups, press **[LOW]** (→) to move the cursor to the right, then press the **Tuning** control to complete the entry and exit Menu mode.
 - If you have entered the maximum of 6 groups, simply press the **Tuning** control to complete the entry and exit Menu mode.

PROGRAM SCAN

Program Scan is identical to VFO Scan except that you select a frequency range for the scan.

■ Setting Scan Limits

You can store up to 10 scan ranges in Memory channels L0/U0 to L9/U9.

- 1 Select your desired band.
- 2 Press **[VFO]**.
- 3 Rotate the **Tuning** control to select your desired frequency for the lower limit.

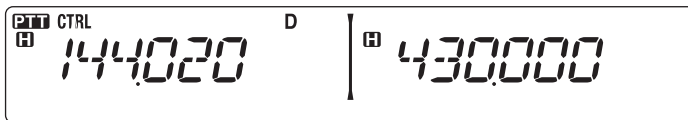

- 4 Press **[F]**.
 - A memory channel number appears and blinks.
- 5 Rotate the **Tuning** control to select a channel from L0 to L9.



- 6 Press **[MR]** to set the channel number.
 - The lower limit is stored in the channel.
- 7 Rotate the **Tuning** control to select your desired frequency for the lower limit.

- 8 Press **[F]**.
 - 9 Rotate the **Tuning** control to select a matching channel number from U0 to U9.
 - For example, if you select channel L3 in step 5, select channel U3 here.
 - 10 Press **[MR]** to set the channel number.
 - The upper limit is stored in the channel.
 - To confirm the stored scan limits, press **[MR]**, then select the L and U channels.
-

Note:

- ◆ The lower limit must be lower in frequency than the upper limit.
 - ◆ The lower and upper frequency step sizes must be equal.
 - ◆ The lower and upper limits must be selected on the same band.
-

■ Using Program Scan

- 1 Select your desired band.
 - 2 Press **[VFO]**.
 - 3 Rotate the **Tuning** control to select a frequency within your desired scan range.
 - 4 Press **[VFO] (1s)**.
 - Scan starts at the current frequency.
 - The 1 MHz decimal blinks while scanning is in progress.
 - To reverse the scan direction, turn the **Tuning** control clockwise (upward scan) or counterclockwise (downward scan). You can also press microphone **[UP]/[DWN]**.
 - 5 To quit Program Scan, press **[VFO]** again.
-

Note:

- ◆ If the step size differs between the lower limit and upper limit, VFO scan will begin instead of Program Scan.
 - ◆ If the current VFO frequency is within more than one Program Scan range, the range stored in the smallest channel number is used.
-

MHz SCAN

MHz Scan monitors a 1 MHz segment of the band, using the current frequency step size. The current 1 MHz digit determines the limits of the scan. For example, if the current frequency is 145.400 MHz, then the scan range would be from 145.000 MHz to 145.995 MHz (the exact upper limit depends on the current frequency step size).

- 1 Select your desired band.
- 2 Press **[VFO]**.
- 3 Rotate the **Tuning** control to select a frequency within your desired 1 MHz range.
- 4 Press and hold the **Tuning** control for 1 second to start scanning.
 - Scan starts at the current frequency.
 - The 1 MHz decimal blinks while scanning is in progress.
 - To reverse the scan direction, turn the **Tuning** control clockwise (upward scan) or counterclockwise (downward scan). You can also press microphone **[UP]/ [DWN]**.
- 5 To quit MHz Scan, press the **Tuning** control again.

CALL SCAN

Use Call Scan to monitor both the Call channel and either the currently selected VFO frequency or the currently selected Memory channel.

- 1 Select your desired VFO frequency or Memory channel.
- 2 Press **[CALL] (1s)** to start Call Scan.
 - The 1 MHz decimal blinks while scanning is in progress.
 - When scanning a Memory channel, the Call channel on the same band as the selected Memory channel is used for scan.
- 3 To quit Call Scan, press **[CALL]** again.

Note: The Memory channel selected is scanned even if it has been locked out of scan.

CONTINUOUS TONE CODED SQUELCH SYSTEM (CTCSS)

You may sometimes want to hear calls only from specific persons. The Continuous Tone Coded Squelch System (CTCSS) allows you to ignore (not hear) unwanted calls from other persons who are using the same frequency. To do so, select the same CTCSS tone as selected by the other persons in your group. A CTCSS tone is subaudible and is selectable from among 42 tone frequencies.

Note: CTCSS does not cause your conversation to be private. It only relieves you from listening to unwanted conversations.

USING CTCSS

- 1 Select your desired band.
- 2 Press **[TONE]** 2 times to activate the CTCSS function.
 - The **CT** icon appears on the display when the CTCSS function is ON.
 - Each press of **[TONE]** changes the selection as follows:
Tone (T) → CTCSS (CT) → DCS (DCS) → Off (no display).

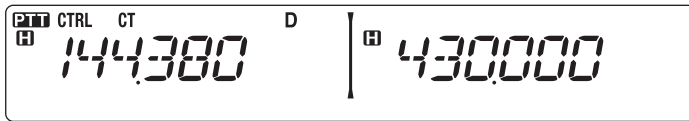

- 3 Press **[F]**, **[TONE]**.
 - The current CTCSS frequency appears on the display and blinks.

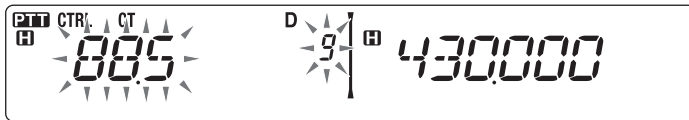

- 4 Rotate the **Tuning** control to select your desired CTCSS frequency.
 - Refer to the table below for the available frequencies.
 - To exit the CTCSS frequency selection, press **[F]** (**ESC**).
- 5 Press any key other than the **Tuning** control and **[F]** (**ESC**) to complete the setting.
- 6 **When you are called:** The transceiver squelch opens only when the selected CTCSS tone is received.
When you make a call: Press and hold **[PTT]**, then speak into the microphone.
 - To cancel CTCSS, press **[TONE]** until CT no longer appears on the display.

You can also select a CTCSS frequency by using the microphone:

- 1 Select your desired band.
- 2 Press **[TONE]** 2 times to activate the CTCSS function.
 - The **CT** icon appears on the display when the CTCSS function is ON.
 - Each press of **[TONE]** changes the selection as follows:
Tone (T) → CTCSS (CT) → DCS (DCS) → Off (no display).
- 3 Press **[F]**, **[TONE]**.
 - The current CTCSS frequency appears on the display and blinks.
- 4 Press the key programmed as **[ENTER]**.

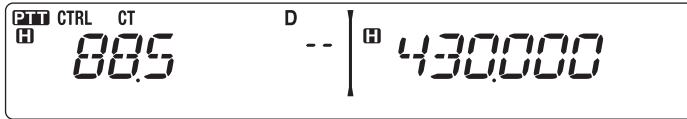

- 5 Enter a frequency reference number (01 ~ 42) using the microphone keypad.
 - Refer to the table below for frequencies and their reference numbers.
- 6 Press **[ENTER]** again to complete the setting.

No.	Frequency (Hz)	No.	Frequency (Hz)	No.	Frequency (Hz)	No.	Frequency (Hz)
01	67.0	12	97.4	23	141.3	34	206.5
02	69.3	13	100.0	24	146.2	35	210.7
03	71.9	14	103.5	25	151.4	36	218.1
04	74.4	15	107.2	26	156.7	37	225.7
05	77.0	16	110.9	27	162.2	38	229.1
06	79.7	17	114.8	28	167.9	39	233.6
07	82.5	18	118.8	29	173.8	40	241.8
08	85.4	19	123.0	30	179.9	41	250.3
09	88.5	20	127.3	31	186.2	42	254.1
10	91.5	21	131.8	32	192.8		
11	94.8	22	136.5	33	203.5		

CTCSS FREQUENCY ID

This function scans through all CTCSS frequencies to identify the incoming CTCSS frequency on a received signal. You may find this useful when you cannot recall the CTCSS frequency that the other persons in your group are using.

1 Press **[TONE]** 2 times to activate the CTCSS function.

- The **CT** icon appears on the display when the CTCSS function is ON.
- Each press of **[TONE]** changes the selection as follows:
Tone (T) → CTCSS (CT) → DCS (DCS) → Off (no display).

2 Press **[F]**, **[TONE]** (1s).

- The **CT** icon blinks and “SCAN” appears on the display.
- Scan starts when a signal is received.

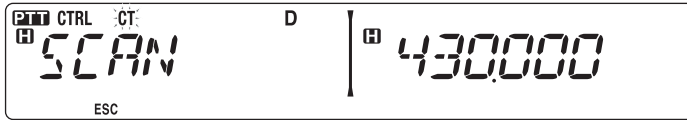

- To reverse the scan direction, turn the **Tuning** control clockwise (upward scan) or counterclockwise (downward scan). You can also press microphone **[UP]**/ **[DWN]**.
- To quit the scan, press **[F]** (**ESC**).
- When a CTCSS frequency is identified, the identified frequency appears on the display and blinks.

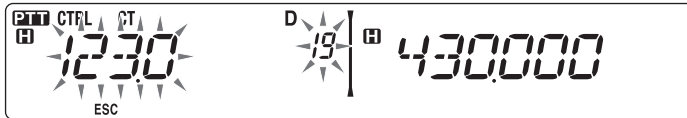

3 Press the **Tuning** control to program the identified frequency in place of the currently set CTCSS frequency.

- The CTCSS function will remain ON. To cancel CTCSS, press **[TONE]** until CT no longer appears on the display.
- Press **[F]** (**ESC**) if you do not want to program the identified frequency.
- Rotate the **Tuning** control while an identified frequency is blinking, to resume scanning.

DIGITAL CODED SQUELCH (DCS)

Digital Code Squelch (DCS) is another application which allows you to ignore (not hear) unwanted calls. It functions the same way as CTCSS. The only differences are the encode/ decode method and the number of selectable codes. For DCS, you can select from 104 different codes.

USING DCS

- 1 Select your desired band.
- 2 Press **[TONE]** 3 times to activate the DCS function.
 - The **DCS** icon appears on the display when the DCS function is ON.
 - Each press of **[TONE]** changes the selection as follows:
Tone (T) → CTCSS (CT) → DCS (DCS) → Off (no display).

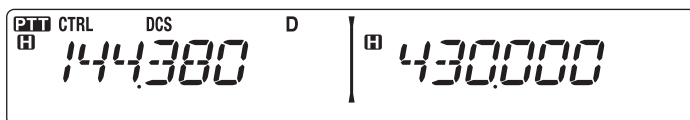

- 3 Press **[F]**, **[TONE]**.
 - The current DCS code appears on the display and blinks.

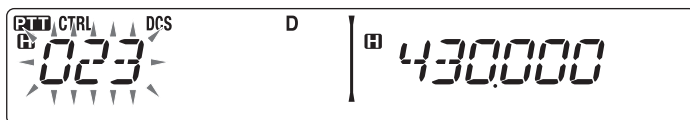

- 4 Rotate the **Tuning** control to select your desired DCS code.
 - Refer to the table below for the available codes.
 - To exit the DCS code selection, press **[F]** (**ESC**).
- 5 Press any key other than the **Tuning** control and **[F]** (**ESC**) to complete the setting.
- 6 **When you are called:** The transceiver squelch opens only when the selected DCS code is received.
When you make a call: Press and hold **[PTT]**, then speak into the microphone.
 - To cancel DCS, press **[TONE]** until DCS no longer appears on the display.

You can also select a DCS code by using the microphone:

- 1 Select your desired band.
- 2 Press **[TONE]** 3 times to activate the DCS function.
 - The **DCS** icon appears on the display when the DCS function is ON.
 - Each press of **[TONE]** changes the selection as follows:
Tone (T) → CTCSS (CT) → DCS (DCS) → Off (no display).
- 3 Press **[F]**, **[TONE]**.
 - The current DCS code appears on the display and blinks.
- 4 Press the key programmed as **[ENTER]**.

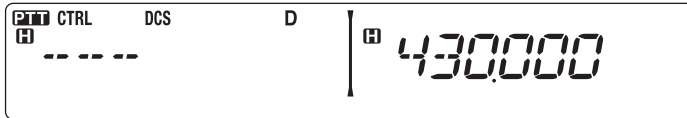

- 5 Enter your desired DCS code using the microphone keypad.
 - Refer to the table below for DCS codes.
- 6 Press **[ENTER]** again to complete the setting.

DCS Code							
023	025	026	031	032	036	043	047
051	053	054	065	071	072	073	074
114	115	116	122	125	131	132	134
143	145	152	155	156	162	165	172
174	205	212	223	225	226	243	244
245	246	251	252	255	261	263	265
266	271	274	306	311	315	325	331
332	343	346	351	356	364	365	371
411	412	413	423	431	432	445	446
452	454	455	462	624	465	466	503
506	516	523	565	532	546	565	606
612	624	627	631	632	654	662	664
703	712	723	731	732	734	743	754

DCS CODE ID

This function scans through all DCS codes to identify the incoming DCS code on a received signal. You may find it useful when you cannot recall the DCS code that the other persons in your group are using.

1 Press **[TONE]** 3 times to activate the DCS function.

- The **DCS** icon appears on the display when the DCS function is ON.
- Each press of **[TONE]** changes the selection as follows:
Tone (T) → CTCSS (CT) → DCS (DCS) → Off (no display).

2 Press **[F]**, **[TONE]** (1s).

- The **DCS** icon blinks and “SCAN” appears on the display.
- Scan starts when a signal is received.

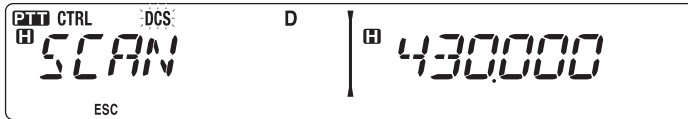

- To reverse the scan direction, turn the **Tuning** control clockwise (upward scan) or counterclockwise (downward scan). You can also press microphone **[UP]**/ **[DWN]**.
- To quit the scan, press **[F]** (**ESC**).
- When a DCS code is identified, the identified code appears on the display and blinks.

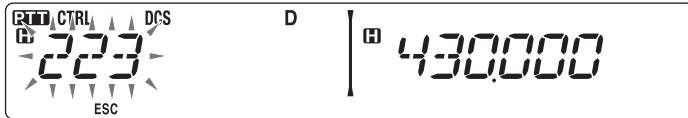

3 Press the **Tuning** control to program the identified code in place of the currently set DCS code.

- The DCS function will remain ON. To cancel DCS, press **[TONE]** until DCS no longer appears on the display.
- Press **[F]** (**ESC**) if you do not want to program the identified code.
- Rotate the **Tuning** control while an identified code is blinking, to resume scanning.

DUAL TONE MULTI-FREQUENCY (DTMF)

The keys on the microphone keypad function as DTMF keys; the 12 keys found on a push-button telephone plus 4 additional keys (A, B, C, D). This transceiver provides 10 dedicated memory channels. You can store a DTMF code with up to 16 digits.

Some repeaters in the U.S.A. and Canada offer a service called Autopatch. You can access the public telephone network via such a repeater by sending DTMF tones. For further information, consult your local repeater reference.

MANUAL DIALING

Manual Dialing requires only two steps to send DTMF tones.

- 1 Press and hold the microphone **[PTT]**.
- 2 Press the keys in sequence on the keypad to send DTMF tones.
 - The corresponding DTMF tones are transmitted.
 - If the DTMF Hold function is activated, you need not hold down **[PTT]** while pressing keys. After transmitting the first tone (by pressing **[PTT]** and the first key), pressing additional keys will keep the transceiver in transmit mode for 2 seconds.

Frequency (Hz)	1209	1336	1447	1633
697	[1]	[2]	[3]	[A]
770	[4]	[5]	[6]	[B]
852	[7]	[8]	[9]	[C]
941	[*]	[0]	[#]	[D]

■ DTMF Hold

Activate this function to remain in transmit mode, after beginning to press keys when making a call.

- 1 Enter Menu mode and access Menu 300 (DT.HOLD) {page 20}.



- 2 Set DTMF Hold to ON to continue transmitting when pressing keys.
 - Set this menu to OFF to stop the 2 second continuous transmission.

AUTOMATIC DIALER

There are 10 dedicated DTMF Memory channels available to store DTMF codes. You can store up to 16 digits in each channel.

■ Storing a DTMF Code in Memory

- 1 Enter Menu mode and access Menu 301 (DT.MEM) {page 20}.



- 2 Rotate the **Tuning** control to select a channel number.
- 3 Press the **Tuning** control to set the selected channel number.
 - The name entry display appears.



- 4 Enter a name for the channel {page 24}, then press the **Tuning** control to set it.
 - The code entry display appears.



- 5 Enter a DTMF code for the channel {page 24}, then press the **Tuning** control to set it.

■ Transmitting Stored DTMF Codes

- 1 Press and hold the microphone [PTT].
- 2 While transmitting, press the **Tuning** control.
 - The last called DTMF Memory channel name and number appear on the display. If no name has been saved for the channel, the DTMF code appears.

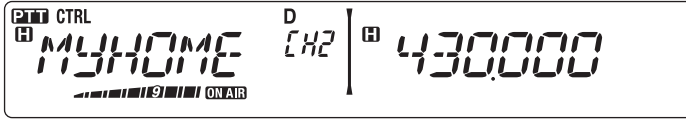

- 3 While still transmitting, rotate the **Tuning** control to select your desired DTMF Memory channel, then press the **Tuning** control to set the channel.
 - Additionally, you can press a DTMF key corresponding to your desired channel ([0] ~ [9]) to select the channel and begin transmission.
 - The stored DTMF code scrolls across the display and is transmitted.
 - The code will be transmitted even if you release [PTT] before the entire code has scrolled across the display.
 - If no DTMF code is stored in the selected channel, the frequency display is restored.

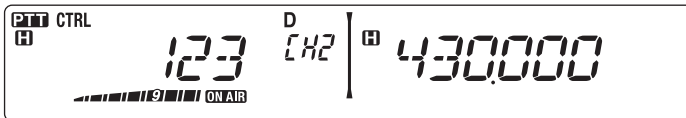
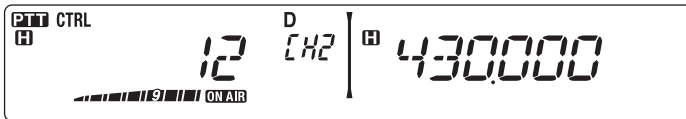
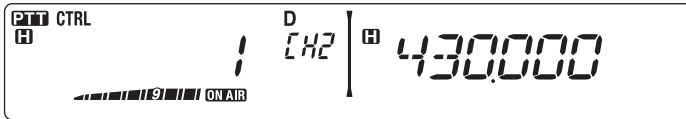

■ Selecting a Transmit Speed

Some repeaters may not respond correctly if a DTMF code is transmitted at fast speed. If this happens, change the DTMF code transmission speed from FAST (default) to SLOW.

- 1 Enter Menu mode and access Menu 302 (DT.SPD) {page 20}.

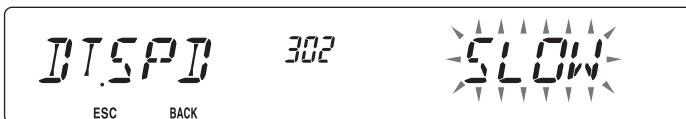

- 2 Set the speed to FAST or SLOW.

■ Selecting a Pause Duration

You can change the pause duration stored in DTMF Memory channels; the default is 500 msec.

- 1 Enter Menu mode and access Menu 303 (DT.PAUS) {page 20}.



- 2 Select a speed (in msec) from the available list: 100/ 250/ 500/ 750/ 1000/ 1500/ 2000.

DTMF KEY LOCK

This function will lock the DTMF transmission keys so that they will not transmit if they are accidentally pressed. To lock the DTMF keys, turn this function ON.

- 1 Enter Menu mode and access Menu 304 (DT.LOCK) {page 20}.



- 2 Set the key lock to ON or OFF.

WHAT IS EchoLink?

EchoLink allows you to communicate with other amateur radio stations over the internet, using VoIP (voice-over-IP) technology. The EchoLink software program allows worldwide connections to be made between stations, or from computer to station, greatly enhancing your communications capabilities.

To use EchoLink, you must register using your call sign on their website and download the EchoLink software program (free of charge). Refer to the website for PC hardware and other requirements.

Official EchoLink Website: <http://www.echolink.org>

Note: EchoLink is a registered trademark of Synergenics, LLC.

STORING EchoLink MEMORY

There are 10 dedicated EchoLink DTMF Memory channels available to store DTMF codes. You can store up to 8 digits in each channel.

- 1 Enter Menu mode and access Menu 204 (ELK.MEM) {page 20}.

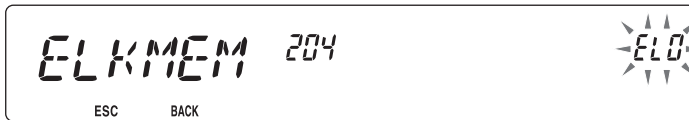

- 2 Rotate the **Tuning** control to select an EchoLink channel number from EL0 ~ EL9.
- 3 Press the **Tuning** control to set the selected channel number.
 - The name entry display appears.



- 4 Enter the name for the channel {page 24}, then press the **Tuning** control to set it.
 - The code entry display appears.



- 5 Enter a DTMF code for the channel {page 24}, then press the **Tuning** control to set it.

■ Transmitting EchoLink Memory

- 1 Select the band and frequency of the node to which you want to connect.
- 2 Press and hold the microphone [PTT].
- 3 While transmitting, press the **Tuning** control.
 - The last called EchoLink DTMF Memory channel name and number appears on the display.

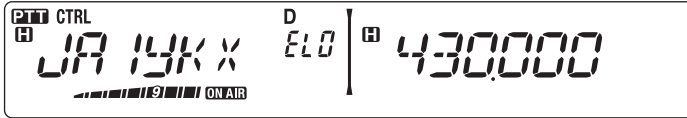

- 4 While still transmitting, rotate the **Tuning** control to select your desired EchoLink Memory channel, then press the **Tuning** control to set the channel.
 - The stored code scrolls across the display and is transmitted.
 - The code will be transmitted even if you release [PTT] before the entire code has scrolled across the display.
 - When only a name has been stored, the DTMF code for that name appears on the display. The Call Sign code is automatically preceded with a "C" and ends with a "#". DTMF values are listed in the following table:

	1	2	3	4	5	6	7	8	9	0
0	1	2	3	4	5	6	7	8	9	0
1	Q	A	D	G	J	M	P	T	W	
2	Z	B	E	H	K	N	R	U	X	
3		C	F	I	L	O	S	V	Y	

So, for example, if the Call Sign being transmitted was JA1YKX, the display would read: C 51 21 10 93 52 92 #

However, if characters other than letters or numbers are used (such as a hyphen of a space), only the DTMF code for characters before that non-regular character are displayed. All subsequent characters will not appear on the display.

- If no data is stored in the selected channel, the frequency display is restored.

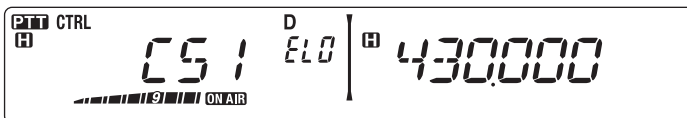
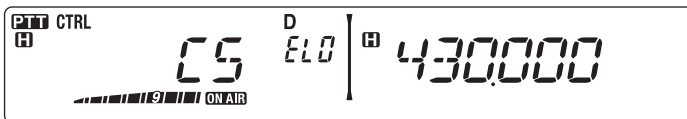
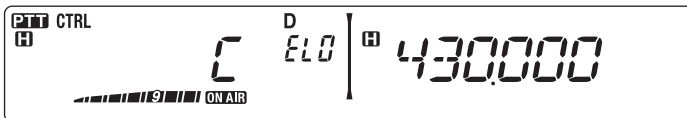

■ Selecting a Transmit Speed

Some repeaters may not respond correctly if a code is transmitted at fast speed. If this happens, change the EchoLink transmission speed from FAST (default) to SLOW.

- 1 Enter Menu mode and access Menu 205 (ELK.SPD) {page 20}.



- 2 Set the speed to FAST or SLOW.

SETTING UP EchoLink Sysop MODE

When connected to a PC, you can set whether or not to use the RTS and CTS terminals for hard flow control, or the SQC and PKS terminals for EchoLink. The action band is the data band (Menu 517(DAT.BND)).

- 1 Turn the transceiver power OFF.
- 2 Press **[PF2] + Power ON** to turn EchoLink Sysop Mode ON.
 - The  icon appears on the display when EchoLink Sysop mode is ON.

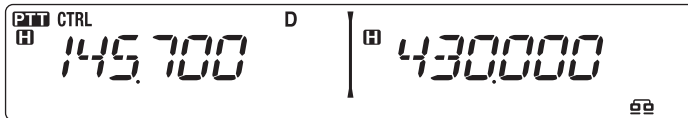

- To turn EchoLink Sysop Mode OFF, press **[PF2] + Power ON** again.

EchoLink Sysop Mode ON		
TM-V71		PC
TxD	→	RxD
RxD	←	TxD
SQC	→	CTS
PKS	←	RTS
GND	↔	GND

EchoLink Sysop Mode OFF		
TM-V71		PC
TxD	→	RxD
RxD	←	TxD
RTS	→	CTS
CTS	←	RTS
GND	↔	GND

Note:

- ◆ When in EchoLink Sysop mode, you cannot change to Repeater mode or Remote Control mode. Additionally, you cannot use the MCP-2A (memory control program) software.
- ◆ We recommend you set Menu 520's SQC output setting to SQL when using EchoLink Sysop mode.

AUXILIARY FUNCTIONS

POWER-ON MESSAGE

Each time you switch the transceiver ON, "HELLO" (default) appears on the display for approximately 2 seconds. You can program your favorite message in place of the default message.

- 1 Enter Menu mode and access Menu 500 (P.ON.MSG) {page 20}.



- 2 Enter your desired message {page 24}.
 - Press [PF1] (CLR) to clear the entire message, if necessary.

DISPLAY BRIGHTNESS

You can manually change the display illumination to suit the lighting conditions where you are operating.

- 1 Enter Menu mode and access Menu 501 (BRIGHT) {page 20}.

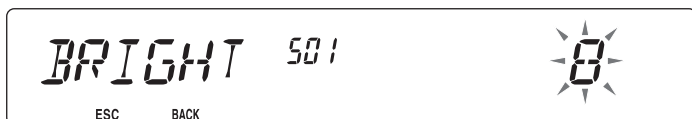

- 2 Set your desired brightness level from 1 to 8, or OFF.

■ Auto Display Brightness

When Auto Brightness is activated, the display will light up every time a key is pressed.

- 1 Enter Menu mode and access Menu 502 (AUTO.BR) {page 20}.

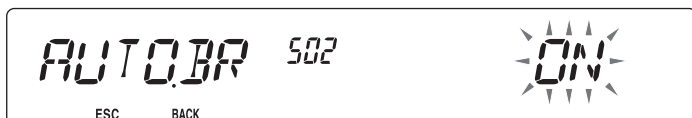

- 2 Set the Auto Brightness function to ON or OFF.

■ Backlight Color

You can manually change the display illumination to suit the lighting conditions where you are operating.

- 1 Enter Menu mode and access Menu 503 (COLOR) {page 20}.



- 2 Set the backlight color to AMBER or GREEN.

KEY LOCK

The Key Lock function ensures that your transceiver settings will remain unchanged if you accidentally press a key. When activated, the following functions can still be used:

- [P] [O]
- [PTT]

To turn Key Lock ON or OFF, press [F] (1s).

- When Key Lock is activated, the  icon will appear on the display.

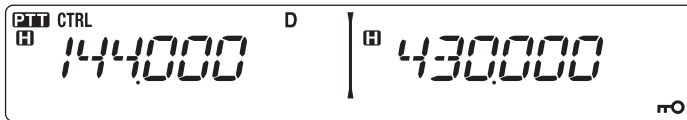

■ Microphone Key Lock

The Microphone Key Lock function will lock the microphone PF (Programmable Function) keys.

- 1 Enter Menu mode and access Menu 513 (MIC.LCK) {page 20}.

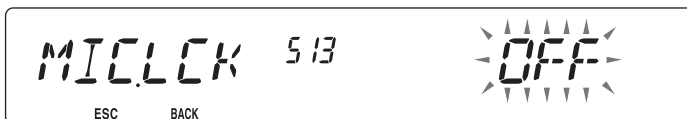

- 2 Turn the Microphone Key Lock function ON or OFF.

KEY BEEP

You can turn the transceiver beep function ON or OFF as desired.

- 1 Enter Menu mode and access Menu 000 (BEEP) {page 20}.



- 2 Turn the beep function ON or OFF.

- Even with the beep function turned OFF, the transceiver will emit a beep tone under the following conditions:
 - 1) When Auto Power Off is activated, the transceiver will beep 1 minute before the power turns off.
 - 2) After transmitting for the maximum time duration according to the Time-out Timer, the transceiver will beep

■ Beep Volume

Each time you press a key, the beep tone will sound. If you have left the beep function turned ON, you may wish to adjust the volume level of the beep.

- 1 Enter Menu mode and access Menu 001 (BP.VOL) {page 20}.

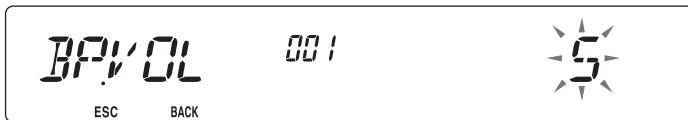

- 2 Set the beep volume to a level from 1 to 7.
 - The default is level 5.

PROGRAMMABLE VFO

If you always check frequencies within a certain range, you can set upper and lower limits for frequencies that are selectable. For example, if you select 144 MHz for the lower limit and 145 MHz for the upper limit, the tunable range will be from 145.000 MHz to 146.995 MHz.

- 1 Press the left or right **[BAND SEL]** to set band A or B as the operating band, then press **[VFO]**.
- 2 Enter Menu mode and access Menu 100 (PRG.VFO) {page 20}.
(Example: E type)



- 3 Press the **Tuning** control.
 - The lower frequency limit blinks.



- 4 Rotate the **Tuning** control to select your desired lower frequency limit, then press the **Tuning** control to set the selected value.
 - The upper frequency limit blinks.

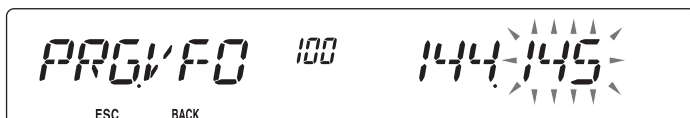

- When setting the limit for the 1200 MHz band, the 1 MHz digit appears on the 7-segment display to the right of the main display.



- 5 Rotate the **Tuning** control to select your desired upper frequency limit, then press the **Tuning** control to set the selected value.
- 6 Press **[CALL] (ESC)** to exit Menu mode.

Note: You cannot program the 100 kHz and subsequent digits. The exact 100 kHz and subsequent digits of the upper limit depend on the frequency step size you are using.

CHANGING THE FREQUENCY STEP SIZE

Choosing the correct frequency step size is essential in selecting your exact frequency. The default step size on the 144 MHz band is 5 kHz (K type) or 12.5 kHz (E, M4 types). The default on the 430/440 MHz band is 25 kHz. For K type models, the default on the 118, 220, or 300 MHz band is 12.5 kHz and the default on the 1200 MHz band is 25 kHz.

- 1 Press the left or right **[BAND SEL]** to select band A or B, then press **[VFO]**.
- 2 Enter Menu mode and access Menu 101 (STEP) {page 20}.

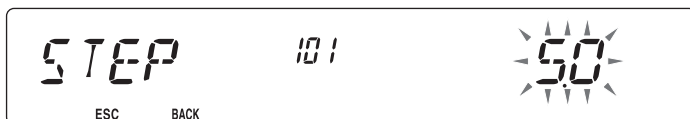

- 3 Set the step size to 5.0*, 6.25*, or 8.33 kHz (118 MHz band only) or to 10.0, 12.5, 15.0*, 20.0, 25.0, 30.0, 50.0, or 100.0 kHz.

* These step sizes are not available for the 1200 MHz band.

Note: Changing between step sizes may correct the displayed frequency. For example, if 144.995 MHz is displayed with a 5 kHz step size selected, changing to a 12.5 kHz step size corrects the displayed frequency to 144.9875 MHz.

PROGRAMMABLE FUNCTION KEYS

■ Transceiver Front Panel

There are 2 PF (Programmable Function) keys on the transceiver front panel: PF1 and PF2. You can assign your own desired functions to these 2 keys.

- 1 Enter Menu mode and access Menu 507 (PF1) and/or Menu 508 (PF2) {page 20}.



- 2 Set your desired function for the key. Programmable functions available are: WX CH (Weather Channel)/ FR.BAND (Frequency bands)/ CTRL (Control)/ MONI (Monitor)/ VGS (Voice recorder)/ VOICE (Voice announcement)/ GRP.UP (Memory group up)/ MENU (Menu mode)/ MUTE (Speaker Mute)/ SHIFT (Shift)/ DUAL (Dual Mode)/ M>V (Memory to VFO Copy)/ 1750 (1750 Hz Tone).

■ Microphone Keys

There are 4 microphone PF (Programmable Function) keys: [PF] (PF1), [MR] (PF2), [VFO] (PF3) and [CALL] (PF4). You can assign your own desired functions to these 4 keys.

- 1 Enter Menu mode and access Menu 509 (MIC.PF1) and/or Menu 510 (MIC. PF2) and/or Menu 511 (MIC. PF3) and/or Menu 512 (MIC. PF4) {page 20}.

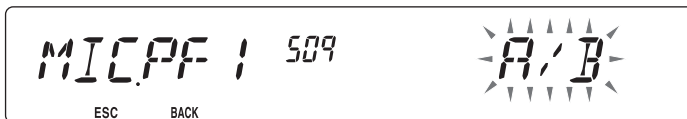

- 2 Set your desired function for the key. Programmable functions available are: WX CH (Weather Channel)/ FR.BAND (Frequency bands)/ CTRL (Control)/ MONI (Monitor)/ VGS (Voice recorder)/ VOICE (Voice announcement)/ GRP.UP (Memory group up)/ MENU (Menu mode)/ MUTE (Speaker Mute)/ SHIFT (Shift)/ DUAL (Dual Mode)/ M>V (Memory to VFO Copy)/ VFO/ MR/ CALL/ MHz/ TONE/ REV (Reverse)/ LOW/ LOCK/ A/B (Band Select A/ Band Select B)/ ENTER/ 1750 (1750 Hz Tone).

FREQUENCY DIRECT ENTRY

If the desired operating frequency is far from the current frequency, using the microphone keypad is the quickest way to change the frequency. One of the microphone PF keys must first be programmed as ENTER {page 66},

- 1 Press the left or right [**BAND SEL**] to select band A or B, then press [**VFO**] or [**CALL**].
- 2 Press the key programmed as [**ENTER**].
 - The Direct Frequency Entry display appears.

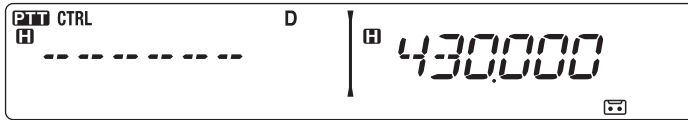

- 3 Press the microphone keys ([0] ~ [9]) to enter your desired frequency.
- 4 To set the entered frequency, press [**ENTER**] or [**VFO**].
 - Pressing [**ENTER**] before entering all of the digits will set the remaining digits to 0.
 - Pressing [**VFO**] before entering all of the digits will leave the remaining digits at their previous values.
 - Entering all digits for a frequency will automatically set the frequency without pressing [**ENTER**] or [**VFO**].
 - If you need to only change the MHz digit, press the **Tuning** control, then enter the new value.

AUTOMATIC POWER OFF (APO)

Automatic Power Off is a background function that monitors whether or not any operations have been performed (keys pressed, **Tuning** control turned, etc.), and turns the transceiver power OFF if it has not been in use.

- 1 Enter Menu mode and access Menu 516 (APO) {page 20}.

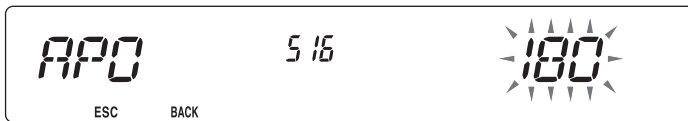

- 2 Set the APO time limit to 30, 60, 90, 120, 180 minutes, or OFF.
 - After the time limit passes with no operations (default is 180 minutes), APO turns the transceiver power OFF. However, 1 minute before the power turns OFF, "APO" appears on the display and blinks, and a warning tone sounds.

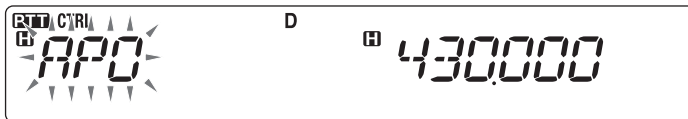

Note: If any settings are changed during while APO is ON, the timer resets. When you stop changing the settings, the timer begins counting again from 0.

S-METER SQUELCH

S-meter Squelch causes the squelch to open only when a signal with the same or greater strength than the S-meter setting is received. This function relieves you from constantly resetting the squelch when receiving weak stations that you have no interest in.

- 1 Enter Menu mode and access Menu 105 (S.SQL) {page 20}.



- 2 Set the S-Meter squelch to ON or OFF.
- 3 To select the desired S-meter setting, rotate the left (band A) or right (band B) SQL control depending on which band you have selected.
 - The squelch will open only at the level you have selected (for example, level 9).

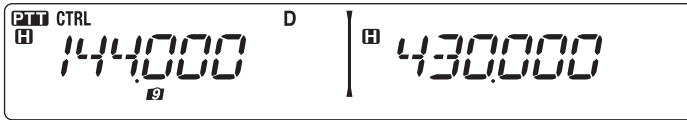

■ Squelch Hang Time

When using S-meter Squelch, you may want to adjust the time interval between when the received signals drop and when the squelch closes.

- 1 Enter Menu mode and access Menu 106 (S.SQ.HNG) {page 20}.



- 2 Set the hang time to 125 or 500 ms, or OFF.

ADVANCED INTERCEPT POINT (AIP)

The VHF/UHF band is often crowded in urban areas. AIP helps eliminate interference and reduce audio distortion caused by intermodulation. You can use this function only while operating on the VHF/UHF band.

- 1 Enter Menu mode and access Menu 103 (VHF.AIP) and/or Menu 104 (UHF.AIP) {page 20}.

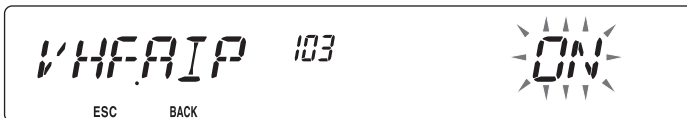

- 2 Set the AIP to ON or OFF.

SWITCHING FM/AM MODE

This transceiver is also capable of receiving (not transmitting) in AM on band A. The default mode on the 118 MHz band is AM while the default on the 144, 220, 300, or 430/440 MHz band is FM.

- 1 Enter Menu mode and access Menu 102 (MODLAT) {page 20}.



- 2 Set the mode to AM, FM, or NFM.

Note: You cannot switch between FM and AM to receive on band B.

BEAT SHIFT

Since the transceiver uses a microprocessor to control various transceiver functions, the CPU clock oscillator's harmonics or image may appear on some spots of the reception frequencies. In this case, we recommend you turn the Beat Shift function ON.

- 1 Enter Menu mode and access Menu 108 (B.SHIFT) {page 20}.

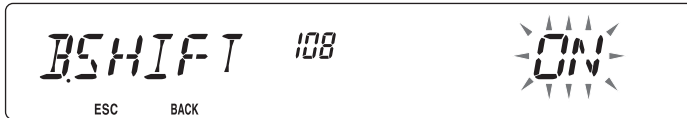

- 2 Set the Beat Shift to ON or OFF.

SPEAKER MUTE

While receiving or transmitting on the TX band, you may not want to hear audio received on the other band. Use this function to mute the speaker allocated to that band (not the TX band).

While receiving, press [F], [LOW] to switch the mute function ON or OFF.

- The MUTE icon appears on the display when the function is ON.

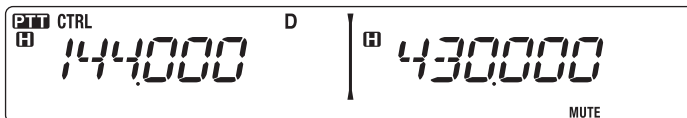

■ Mute Hang Time

When using Speaker Mute, you may want to adjust the time interval between when you receive a signal and when the speaker is muted.

- 1 Enter Menu mode and access Menu 107 (MUT.HNG) {page 20}.



- 2 Set the hang time to 125, 250, 500, 750, or 1000 ms.

SELECTING AN OUTPUT POWER

It is a good idea to select lower transmit power if communications is still reliable. This lowers the risk of interfering with others on the band. When operating from battery power, you will enjoy more operating time before a recharge is necessary.

Press **[LOW]** to select high (H) (K, E types only), medium (M), or low (L) power. .

- You can program different power settings for bands A and B.

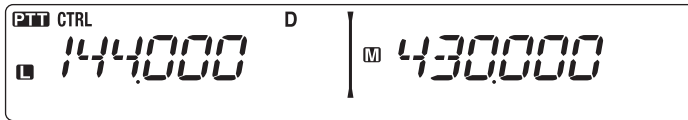

Note: When the transceiver overheats because of ambient high temperature or continuous transmission, the protective circuit may function to lower transmit output power.

TIME-OUT TIMER (TOT)

It is sometimes necessary or desirable to restrict a single transmission to a specific maximum time. You may use this function to prevent repeater time-outs when accessing repeaters, or to conserve battery power.

When TOT times out (default is 10 minutes), the transceiver generates beeps and automatically returns to receive mode. To resume transmitting, release and then press the microphone **[PTT]** again.

- 1 Enter Menu mode and access Menu 109 (TOT) {page 20}.

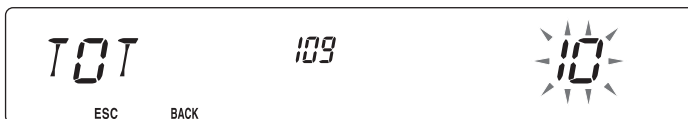

- 2 Set the timer to 3, 5, or 10 minutes.

EXTERNAL SPEAKER CONFIGURATION

This transceiver has two speaker jacks for external speakers, as well as an internal speaker. You can enjoy a variety of speaker configurations by using one or two external speakers. Received signals on bands A and B are output depending on how you want the internal and/or external speakers to function.

- 1 Enter Menu mode and access Menu 002 (EXT.SP) {page 20}.



- 2 Set the speaker mode to MODE 1 or MODE 2.
 - Refer to the table below for configurations based on the mode selected.

Mode	Speaker Setup	Band Output		
		Internal Speaker	External SP1	External SP2
MODE 1	None	A, B	–	–
	SP1 only	x	A, B	–
	SP2 only	A	–	B
	SP1, SP2	x	A	B
MODE 2	None	A, B	–	–
	SP1 only	x	A, B	–
	SP2 only	B	–	A
	SP1, SP2	x	B	A

MASKING A BAND

If you have no plans to use band A or B, you can hide the frequency display on the unused band. This saves power consumption and makes it simpler to read the information you need.

- 1 Turn the transceiver power OFF.
- 2 Press the left or right **[BAND SEL] + Power ON**.
 - The band mask display appears.



- 3 Rotate the **Tuning** control to select the band you want to hide (or return to normal).

- 4 Press the **Tuning** control to set the selected band.
- 5 Rotate the **Tuning** control to set the band to select USE or MASK.
 - USE allows you to see and use the band as normal. MASK hides the band on the display.



- 6 Press the **Tuning** control to set the selection.
- 7 Press the **[CALL] (ESC)** to exit.

Note: You cannot operate the masked band nor use it to receive or transmit.

DISPLAY PARTITION BAR

The partition bar that appears between bands A and B can be removed if desired.

- 1 Enter Menu mode and access Menu 527 (DP.BAR) {page 20}.

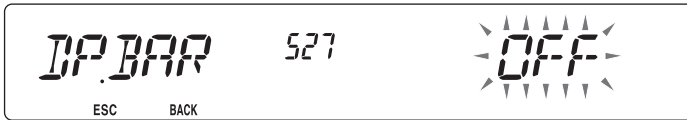

- 2 Set the partition bar display to ON or OFF.

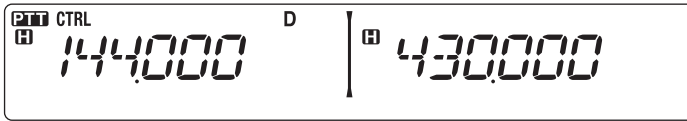

WEATHER ALERT (K TYPE MODELS ONLY)

The Weather Alert is available only in the USA and Canada. When activated, this function will check for a received NOAA 1050 Hz tone. When the tone is received, the weather alert tone will sound.

- 1 Enter Menu mode and access Menu 110 (WX.ALT) {page 20}.

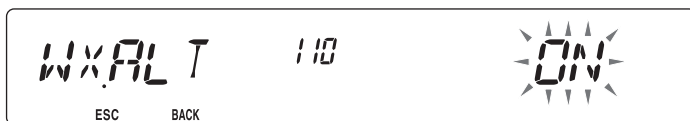

- 2 Set the Weather Alert to ON or OFF.
 - When activated, the **WX** icon appears on the display.
 - When a signal is being received, the **WX** icon blinks.

■ Weather Channel

Whether or not the Weather Alert is activated, you can still access the weather channels. The Weather Alert simply notifies you of activity on the weather channels.

- 1 Press the key programmed with the **WX** function.
- 2 Rotate the **Tuning** control to select your desired channel.

Channel No.	Frequency (MHz)	Memory Name	Location
A1	162.550	WX 1	NOAA/ Canada
A2	162.400	WX 2	NOAA/ Canada
A3	162.475	WX 3	NOAA/ Canada
A4	162.425	WX 4	NOAA
A5	162.450	WX 5	NOAA
A6	162.500	WX 6	NOAA
A7	162.525	WX 7	NOAA
A8	161.650	WX 8	Canada
A9	161.775	WX 9	Canada
A10	163.275	WX 10	—

POWER ON PASSWORD

If power on password is activated, you cannot operate the transceiver without first entering your password, after turning the transceiver power ON. Your password can be changed using the MCP-2A software, and can contain up to 6 digits.

- 1 Enter Menu mode and access Menu 998 (PASSWD) {page 20}.



- 2 Set the power on password to ON or OFF.
 - When set to ON, "PASSWD" appears on the display.

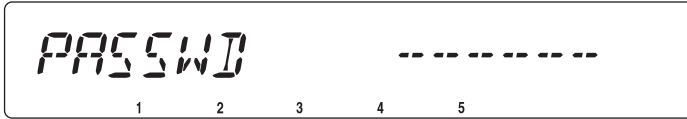

- 3 Enter your password.

[F]: 1
[TONE]: 2
[REV]: 3
[LOW]: 4
[PF1]: 5

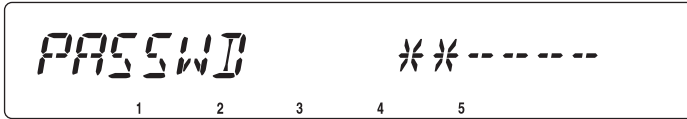

- 4 After entering up to 6 digits, press the **Tuning** control to set the password.

Note: Even with Menu 998 turned ON, the power on password function will not be activated unless you first program a password using the MCP-2A software.

VGS-1 OPTIONAL VOICE GUIDE & STORAGE UNIT

When using the optional VGS-1 voice guide & storage unit, you gain access to the voice recorder and voice announcement functions.

VOICE ANNOUNCEMENTS

When changing modes, frequencies, settings, etc., an audio voice will announce the new information.

- 1 Enter Menu mode and access Menu 003 (ANN) {page 20}.



- 2 Set the announcement function to MANUAL, AUTO, or OFF.
 - Refer to the tables below for announcements based on settings.

MANUAL: A microphone PF key must be programmed as [VOICE] to use MANUAL voice announcement.	
Operation	Announcement
While in VFO mode	Press [VOICE] : Operating band frequency
While in MR mode	Press [VOICE] : "Channel" + Channel number + operating band frequency
While in Call mode	Press [VOICE] : "Call channel" + operating band frequency
While in Menu mode	Press [VOICE] : Menu number or setting value (some selections have no voice announcement)
While setting up Tone/CTCSS/DCS	Press [VOICE] : Current frequency/code

AUTO:

Announcements are made automatically when changing a mode/frequency/setting.

Operation	Announcement
Press [VFO]	"VFO"
Press [MR]	"MR"
Press [CALL]	"Call"
Press [MENU]	"Menu" + menu number
Press [PM]	"PM"
Press [ENT]	"Enter"
Change the operating band/ turn the power ON	"A"/"B" + "Channel" (for MR only) + "Call"/channel number + "Channel" (for CALL only) + operating band frequency + output power level
Change the frequency band	New receive frequency
Setting up the PM	Channel number/"Off"
Frequency direct entry	Entered key number
Memory Direct Entry mode	Channel number
Press [F] in VFO mode	"Memory in" + channel number + frequency
Press [F], [M.IN] in VFO mode	"Memory in" + channel number + "Blank"
Press [A/B] in VFO mode	"A"/"B" + frequency + output power level
Press [F] and then the Tuning control in VFO mode	"Menu" + menu number
Press the Tuning control in Menu mode	Setting value
Perform a Full Reset	"Full reset?"
Perform a Partial Reset	"Partial reset?"
Perform a VFO Reset	"VFO reset?"
Perform a PM Reset	"PM reset?"
Press [LOCK] (to turn the Lock function ON)	"Lock on"
Press [LOCK] (to turn the Lock function OFF)	"Lock off"
Tone frequency setup	"Tone frequency" + frequency value
CTCSS frequency setup	"CTCSS frequency" + frequency value
DCS code setup	"DCS" + code value
MHz step frequency setup	"MHz Step" + frequency value
10 MHz setup	"10" + "MHz setup" + frequency value
Output power setup	"TX Power" + power level

■ Voice Announcement Language

- 1 Enter Menu mode and access Menu 004 (ANN.LNG) {page 20}.



- 2 Set the language to ENG (English) or JPN (Japanese).

■ Voice Announcement Volume

- 1 Enter Menu mode and access Menu 005 (ANN.VOL) {page 20}.



- 2 Set the announcement volume level from 1 to 7.
 - To turn the volume OFF, turn the announcement function OFF.

■ Voice Announcement Speed

- 1 Enter Menu mode and access Menu 006 (ANN.SPD) {page 20}.



- 2 Set the announcement speed level from 0 to 4.
 - The speed settings are as follows:
 - 0: 0.85 times normal speed
 - 1: Normal speed
 - 2: 1.15 times normal speed
 - 3: 1.30 times normal speed
 - 4: 1.45 times normal speed

VOICE RECORDER

The voice recorder provides you with 3 VGS channels for recording voice memos, along with a single VGS channel for recording conversations. You can also prepare automated message responses to received calls.

Each recording can last for up to 30 seconds.

■ Voice Memos

To record a voice memo, for later playback:

- 1 Press the PF key programmed as **[VGS]**.

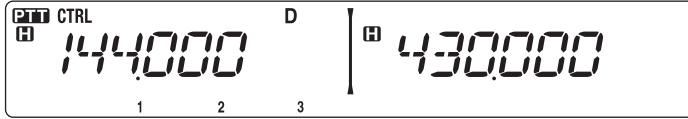

- 2 Press and hold the key for the VGS channel number you want to store the memo in: **[F]** (1), **[TONE]** (2), or **[REV]** (3).

- A beep will sound and the transceiver will enter Recording mode.

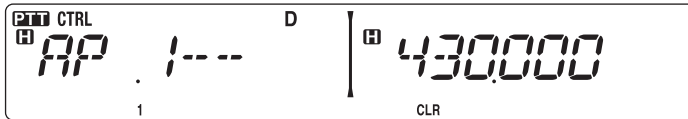

- 3 Press and hold the VGS channel number key again (the same key you pressed in the previous step), then speak into the microphone to record your memo.

- Recording begins as soon as you press the VGS channel number key, and a timer appears on the display.
- Pressing the microphone **PTT** switch at this time will transmit your message as well as record it. Do not press the microphone **PTT** switch if you do not want to transmit your message.

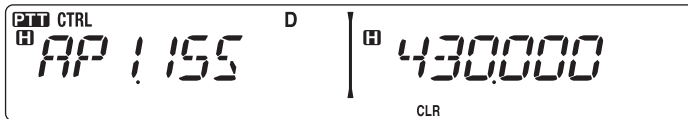

- 4 Release the VGS channel number key to end the recording at any time and store it into the selected VGS channel.

- If the memory becomes full, recording will stop automatically and store the voice memo to memory.
- "WRITING" appears on the display while the recording is being stored to memory.

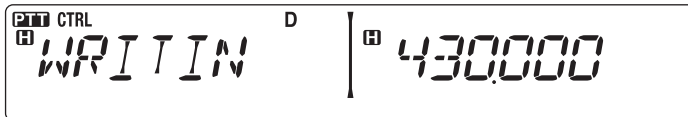



■ Conversation Recorder

To record a 30 second conversation:

- 1 Enter Menu mode and access Menu 009 (CON.REC) {page 20}.



- 2 Set the Conversation Recorder to ON (or OFF).
 - The  icon appears on the display when this function is activated. The  icon does not appear during playback, in Repeater mode, or in Remote Control mode.

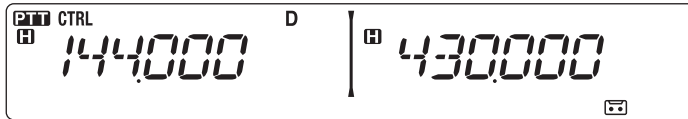

- 3 Press the PF key programmed as [VGS].

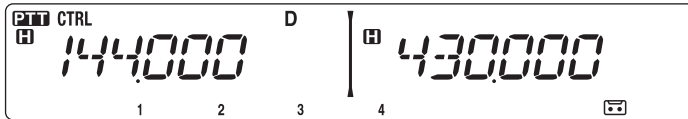

- 4 Press [LOW] (4) (1s) to store the conversation in VGS channel 4.

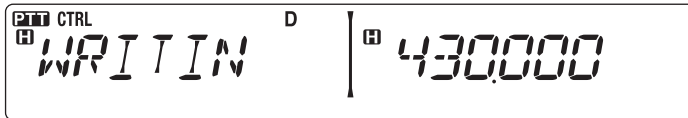

■ Playback

- 1 Press the PF key programmed as **[VGS]**.

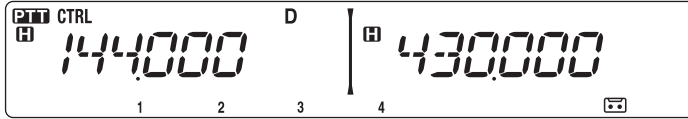

- 2 Press the key for the VGS channel number you want to play back: **[F] (1)**, **[TONE] (2)**, **[REV] (3)**, or **[LOW] (4)** (when the Conversation Recorder is ON.)

- The recording saved in the channel you selected is played back.

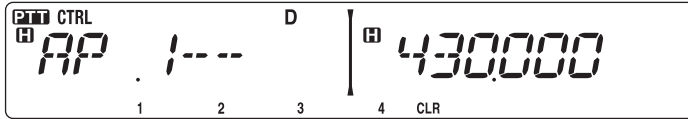

- To end playback at any time, press **[PF1] (CLR)**.
- To exit, press **[VGS]** again.
- During playback, you can switch to any of recordings 1, 2, 3, or 4 by pressing the appropriate key.
- While playing a recording, you can transmit the recording by pressing the **[PTT]** switch. (Continue holding the **[PTT]** switch until the entire recording is transmitted.)

■ Playback Repeat

You can set messages to be repeatedly played back.

- 1 Enter Menu mode and access Menu 007 (PLAY.BK) {page 20}.

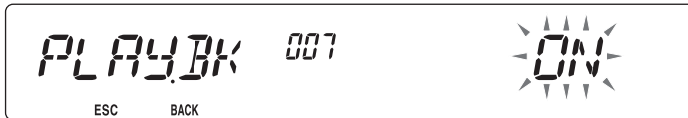

- 2 Set the the Playback Repeat function to ON or OFF.

■ Playback Repeat Interval

If the Playback Repeat function is activated, you can set a time interval for how often the memo/message is played back.

- 1 Enter Menu mode and access Menu 008 (P.BK.INT) {page 20}.



- 2 Set the interval from 0 to 60 seconds.

CROSS-BAND/ LOCKED-BAND OPERATION (K TYPE MODELS ONLY)



This transceiver is capable of receiving signals on one band and retransmitting signals on the other band. This function repeats signals originating from one band, using the other band. For example, a signal received on band A (VHF) is retransmitted on band B (UHF). Similarly, a signal received on band B (UHF) is retransmitted on band A (VHF).

Locked-band Repeater: The transceiver uses the same band to receive or transmit a signal. You can set either the A band (A-TX) or B band (B-TX) as the transmit band.

Cross-band Repeater: If receiving a signal on the TX band, the transceiver switches the current RX only band to the TX band. This is useful when joining in a group talk. Participants in a group talk need to set a receive and transmit frequency on different bands so as not to miss any conversation within the group.

- 1 Enter Menu mode and access Menu 403 (RPT.MOD) {page 20}.



- 2 Set the Repeater operation mode to CROSS (cross-band), A-TX (A band), or B-TX (B band).
- 3 Turn the transceiver power OFF.
- 4 Press **[TONE] + Power ON**.
 - The Repeater mode is ON and the  and  icons blink on the display.
 - You are unable to perform any transceiver functions while in Repeater mode.
 - To return to normal operation, turn the transceiver power OFF, then press **[TONE] + Power ON**.

Note:

- ◆ You cannot activate the Repeater function while in single band operating mode or Weather Channel mode.
 - ◆ Activating the Repeater function switches OFF the Automatic Simplex Checker (ASC).
 - ◆ The Time-Out Timer is locked at 3 minutes.
 - ◆ Resetting the transceiver {page 88} will not cancel the Repeater mode.
-

REPEATER HOLD

If necessary, you can set the transceiver to remain in the transmit mode for 500 ms after a signal drops.

- 1 Enter Menu mode and access Menu 404 (RPT.HLD) {page 20}.



- 2 Set the Repeater Hold function to ON or OFF.

REPEATER ID

If necessary, you can set the transceiver to transmit your call sign every 10 minutes.

- 1 Enter Menu mode and access Menu 406 (ID.TX) {page 20}.



- 2 Set the ID Transmit function to OFF, MORSE, or VOICE.
 - To use VOICE transmission, you must have the VGS-1 option installed. When using the VGS-1 option, the ID Transmit function will use VGS channel 3 as the call sign {page 78}.
 - When selecting MORSE, the call sign stored in Menu 405 {see below} will be transmitted at 20 wpm (words per minute).

■ Entering your Repeater ID

- 1 Enter Menu mode and access Menu 405 (RPT.ID) {page 20}.



- 2 Enter your call sign {page 24}.

PACKET OPERATION

Connect this transceiver to your personal computer via a Terminal Node Controller (TNC). You can send messages or commands to far away stations, obtain a variety of information via your local bulletin boards, or enjoy other Packet applications. Reference material for starting Packet operation should be available at any store that handles Amateur Radio equipment.

Note:

- ◆ When the distance between the radio antenna and your personal computer is too close, interference may occur.
- ◆ Do not share a power source between the transceiver and the TNC. When the distance between the TNC and your personal computer is too close, interference may occur.

Data terminal pins:

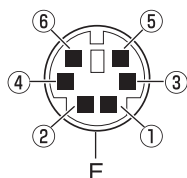

No.	Name	I/O	Function
①	PKD	Input	Audio signal for packet transmission
②	DE	—	PKD terminal ground
③	PKS	Input	'L' is transmitted and the microphone is muted
④	PR9	Output	9600 (bps) repeat signal
⑤	PR1	Output	1200 (bps) repeat signal
⑥	SQC	Output	Squelch control signal; Closed: 'H', Open: 'L' (The default settings can be changed in Menu 520)
	E	—	Common ground

DATA BAND

Select how data will be transmitted and received on your transceiver.

- 1 Enter Menu mode and access Menu 517 (DAT.BND) {page 20}.

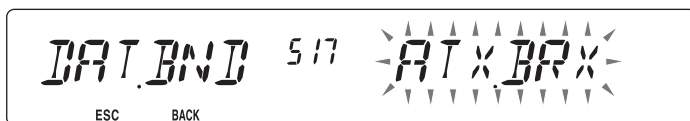

- 2 Set the data band to A (A band receives and transmits), B (B band receives and transmits), ATX.BRX (A band transmits and B band receives), or ARX.BTX (A band receives and B band transmits).

DATA TERMINAL SPEED

Select 1200 or 9600 bps for the data transfer rate, depending on your TNC.

1200 bps: Transmit data input (PKD) sensitivity is 40 mV_{p-p}, and input impedance is 10 kΩ.

9600 bps: Transmit data input (PKD) sensitivity is 2 V_{p-p}, input impedance is 10 kΩ, and the TNC has dual speed capability with a 2 V_{p-p} output.

- 1 Enter Menu mode and access Menu 518 (DAT.SPD) {page 20}.



- 2 Set the data speed to 1200 or 9600 bps.

PC PORT SPEED

You can adjust the speed at which the computer and transceiver exchange information, when the transceiver is connected to your computer.

- 1 Enter Menu mode and access Menu 519 (PC.SPD) {page 20}.

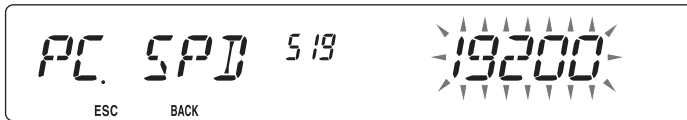

- 2 Set the PC port speed to 9600, 19200, 38400, or 57600 bps.
 - Turning the power ON/OFF will change the port speed setting.

SQC OUTPUT SETTING

You can set the condition for which the SQC output terminal becomes active.

- 1 Enter Menu mode and access Menu 520 (SQC.SRC) {page 20}.

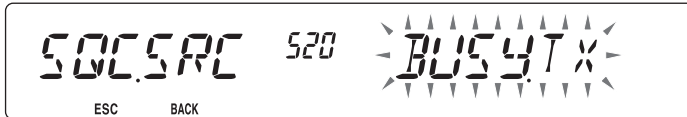

- 2 Set the SQC output activation method to one of the following:
 - OFF: SQC output remains inactive.
 - BUSY: When a signal is received on the data band, the SQC output becomes active.
 - SQL: While CTCSS/DCS is ON and a matching signal is received, the SQC output becomes active. While CTCSS/DCS is OFF, the SQC output becomes active when a busy signal is received.
 - TX: While transmitting, the SQC output becomes active.
 - BUSY.TX: When the conditions of BUSY and TX (above) are met, the SQC output becomes active.
 - SQL.TX: When the conditions of SQL and TX (above) are met, the SQC output becomes active.

Note: The activation type (logic) can be changed using the MCP-2A software.

WIRELESS OPERATION (K TYPE MODELS ONLY)

If you also have a compatible **Kenwood** handy transceiver, you may use it as a remote control for this mobile transceiver. You will control one band on the mobile while sending DTMF tones to the other band from the handheld. This function is useful, for example, when you want to control the mobile from a location outside your vehicle.

Note:

- ◆ As a remote control, you can also use a handy transceiver which does not have a remote control function but a DTMF function. However, you must manually send DTMF tones for control code strings. Skip steps 1 and 3 in "PREPARATION".
- ◆ The FCC rules permit you to send control codes only on the 440 MHz band.

PREPARATION

Let us assume band A (VHF) of the mobile transceiver will be controlled.

On the handy transceiver:

- 1 Program a 3-digit secret number.
 - For the programming method, see the instruction manual for the handheld.
- 2 Select the transmit frequency on the UHF band.
- 3 Make the handheld enter Remote Control mode.
 - For the method, see the instruction manual for the handheld. If not described, consult your dealer.

On the mobile transceiver:

- 4 Enter Menu mode and access Menu 522 (REM.ID) {page 20}.



- 5 Set the ID code to the same secret number you set on the handy transceiver.
- 6 Select the receive frequency on band B (UHF).
 - Match this frequency with the transmit frequency on the handheld.
- 7 Select band A (VHF) as the TX band or Control band.
- 8 To cause the mobile to send a control acknowledgment to the handheld, enter Menu 523 (ANS.BK) and set it to ON.
 - DTMF tones which represent the secret number will be used as an acknowledgment.

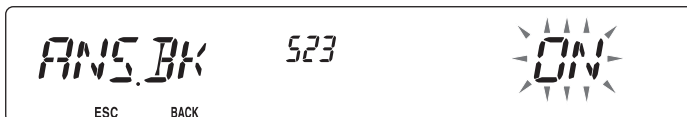

- 9 Turn the transceiver power OFF.

10 Press [REV] + Power ON to enter Remote Control mode.

- The CTRL and  icons appear on the display.
- To exit Remote Control operation, turn the transceiver power OFF, then press [REV] + Power ON again.

CONTROL OPERATION

While in Remote Control mode, the DTMF keys of the handheld will function as shown in the table below. Each time you press the desired key, the handheld will automatically enter transmit mode and send the corresponding command to the mobile.

Operation	DTMF Command
Access your mobile via the remote unit (where *** is your 3-digit secret number)	A *** #
End access of your mobile via the remote unit	A #
DCS ON	1
Tone ON	2
CTCSS ON	3
DCS OFF (all signalling OFF)	4
Tone OFF (all signalling OFF)	5
CTCSS OFF (all signalling OFF)	6
Call mode ON	7
VFO mode ON	8
Memory mode ON	9
Transmit power (press to toggle between High, Medium, and Low)	0
Frequency (in VFO mode) or Memory channel (in Memory mode) directy entry	A XXXXXXXX
DCS code (when DCS is ON), Tone frequency (when Tone is ON), or CTCSS frequency (when CTCSS is ON) setup	B XXX
Repeater (Cross-band or Locked-band) ON	C
Repeater OFF	D
Step the frequency or Memory channel down	*
Step the frequency or Memory channel up	#

TRANSCIVER RESET

There are 4 types of transceiver reset available:

VFO Reset

Use to initialize the VFO and accompanying settings.

PART (Partial) Reset

Use to initialize all settings other than the Memory channels, the DTMF memory, and the PM channels.

PM Reset

Use to reset only the Programmable Memory channels to their default values.

FULL Reset

Use to initialize all transceiver settings that you have customized.

There are 2 ways to perform a reset on the transceiver: by key operation and by accessing Menu mode.

Key Operation:

- 1 Turn the transceiver power OFF.
- 2 Press **[F] + Power ON**.
- 3 Rotate the **Tuning** control and select your desired reset type: VFO, PART, PM, or FULL.



- 4 Press the **Tuning** control to set the reset type.
 - A confirmation message appears on the display.



- Press **[TONE] (BACK)** to return to the previous display or **[F] (ESC)** to cancel the reset.
- 5 Press the **Tuning** control again to perform the reset.



Note: When in Remote Control or Repeater mode, you cannot reset the transceiver using the Key Operation method.

Menu Mode:

- 1 Enter Menu mode and access Menu 999 (RESET) {page 20}.



- 2 Set the reset type to VFO, PART, PM, or FULL.
- 3 Press the **Tuning** control to set the reset type.
 - A confirmation message appears on the display.



- Press **[TONE] (BACK)** to return to the previous display or **[F] (ESC)** to cancel the reset.
- 4 Press the **Tuning** control again to perform the reset.



Note: When the Channel Display function or Key Lock function is ON, the transceiver reset cannot be performed.

OPTIONS

The following options are available for use with this transceiver:

- | | | | |
|----------|--|----------|-----------------------------------|
| • DFK-3D | Detachable Front Panel Kit (3 m) | • PG-3B | Noise Filter |
| • MC-45 | Microphone | • PG-5A | Data Cable |
| • MC-59 | Microphone with keypad | • PG-5G | Programming Interface Cable (2 m) |
| • MCP-2A | Memory Control Program (web download software) | • PG-5H | PC Interface Cable Kit (2 m) |
| • MJ-88 | Microphone Plug Adapter | • PG-5F | Extension Cable Kit (4 m) |
| • MJ-89 | Modular Plug Microphone Switch | • PS-33 | DC Power Supply |
| • PG-2N | DC Cable (2 m) | • PS-53 | DC Power Supply |
| • PG-20 | DC Cable (7 m) | • SP-50B | External Speaker |
| | | • VGS-1 | Voice Guide & Storage Unit |

Note: Optional accessories for use with this transceiver may change, post-production. (New options may become available and/or current options may be discontinued.) Please refer to the options catalog(s) for applicable transceivers.

MEMORY CONTROL PROGRAM MCP-2A

The following functions can be set only by using the MCP-2A software:

- SQC active condition
- Microphone sensitivity level
- 10 MHz mode selection
- Power on password value

Using the MCP-2A software, you can:

- View memory channel groups
- Name memory groups
- Name PM channels
- Save/load settings
- Read exported TravelPlus for Repeaters™ files issued from the ARRL™
- Print/export memory and various settings in html

(TravelPlus for Repeaters is a trademark of ARRL.)

To download the MCP-2A software, go to:

<http://www.kenwood.com/i/products/info/amateur.html>

Note: This URL may change without notice.

■ Using the MCP-2A Software

- 1 Follow the directions of the installer to install the software.
- 2 Set up the PC COM port and baud rate.
- 3 The transceiver data is read from the MCP-2A software.
- 4 Select your desired settings, then write the data to the transceiver.

CONNECTING THE PG-5G/ PG-5H INTERFACE CABLES

The PG-5G package comes with cable ② (below).

The PG-5H packages comes with cables ① and ② (below).

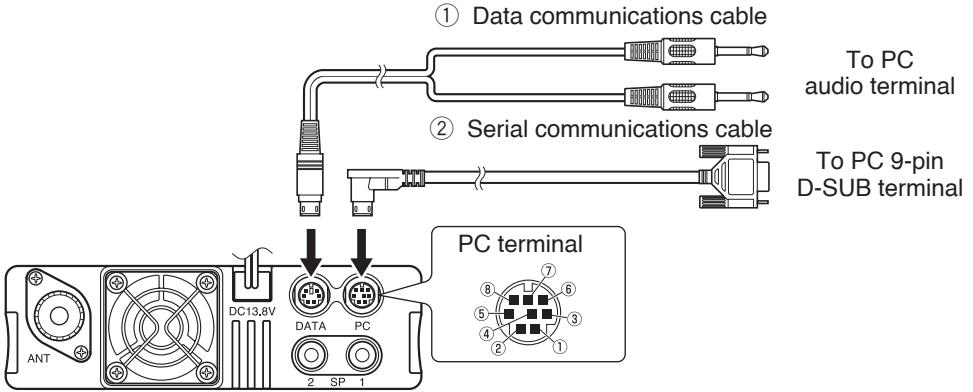

PC terminal pins:

No.	Name	I/O	Function
①	RTS	O	Request to Send
②	CTS	I	Clear to Send
③	TXD	O	Transmit Data
④	GND	—	GND
⑤	RXD	I	Receive Data
⑥	NC	—	—
⑦	NC	—	—
⑧	NC	—	—

Data communications cable pin configuration

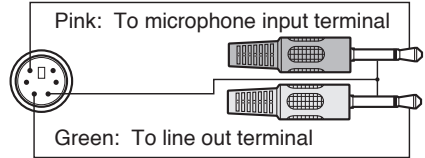

Serial communications cable pin configuration

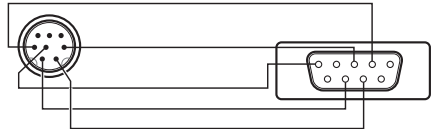

- For DATA terminal, refer to page 83.

INSTALLING THE DFK-3D PANEL KIT

■ Installing the Sub-Panel

- 1 Detach the front operation panel from the base unit, then remove the modular cable from both sides.
- 2 Connect the 4-pin connector of the supplied modular cable to the operation panel.
 - Align the cable with the cable guide.

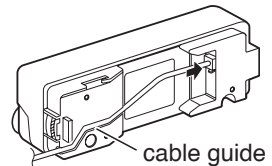
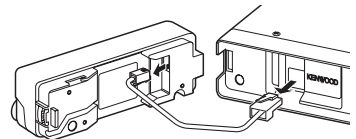

3 Connect the supplied sub-panel to the operation panel.

- Install the sub-panel in a manner so as not to disrupt the cable.

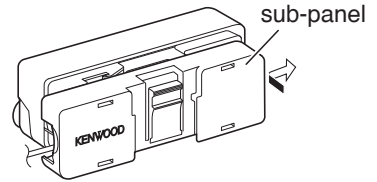

4 Connect the 8-pin connector of the supplied modular cable to the base unit.

- The line filter is pre-installed onto the cable.

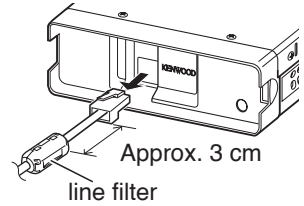

■ Installing the Panel Bracket

1 Clean and dry the installation location.



CAUTION

Do not install the bracket close to an air bag.

2 Remove the release paper from the base of the panel bracket, then secure it in place using the 3 supplied self-tapping screws.

- Allow the panel to set for a while, to ensure it remains fast. Otherwise, vibrations may occur.
- After removing the release paper, it cannot be reused.

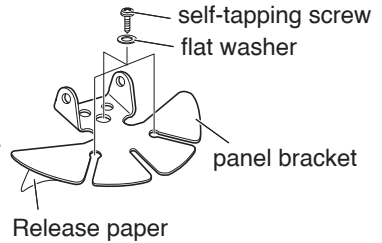

3 Attach the panel holder to the base bracket using the 2 supplied SEMS screws.

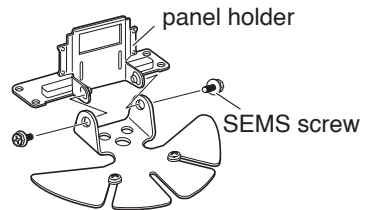

4 Attach the operation panel to the panel holder so that it locks in place.

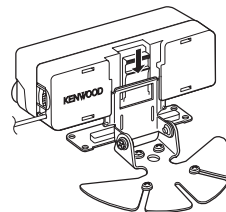

CONNECTING THE PG-5F EXTENSION CABLE

If necessary, the PG-5F extension cable kit can be used with the DFK-3D panel kit. Using two PG-5F kits, you can extend the cables to the maximum length. (Components marked with an asterisk * are included in the PG-5F kit.)

■ Connecting Using a Single Extension Kit

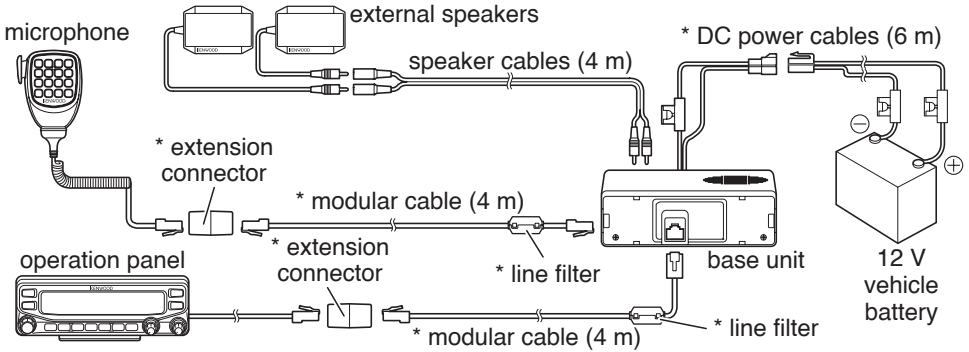

■ Connecting Using Two Extension Kits

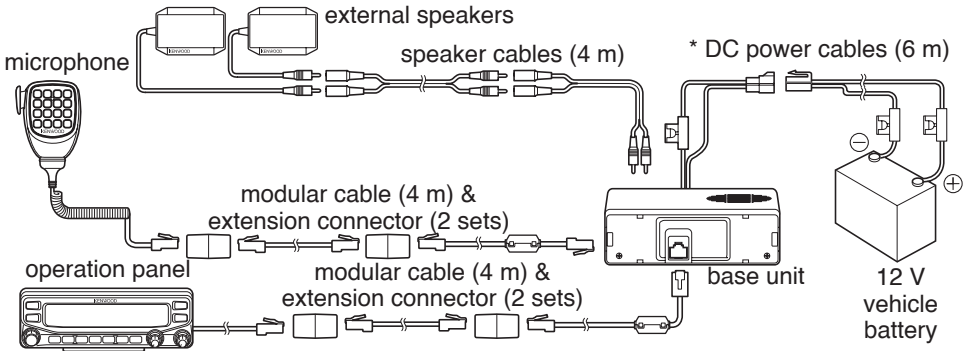

■ Installing the Line Filter

Install the line filter approximately 3 cm from the connector which attaches to the base unit.

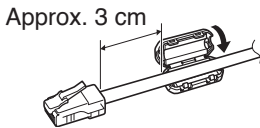

■ Affixing the Microphone Cable

Lock the microphone cable down as shown in the illustration.

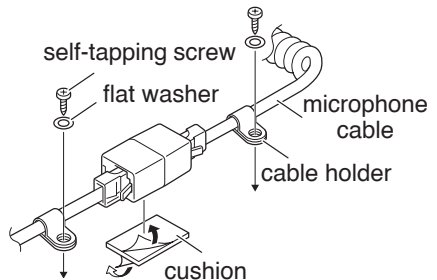

INSTALLING THE VGS-1 UNIT

Follow the instructions below to install the VGS-1 unit.

- 1 Remove the 8 screws from the cover of the base unit, then remove the cover itself from the unit.

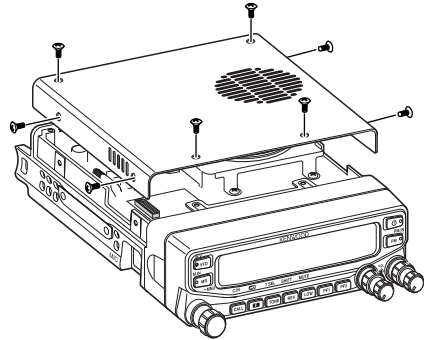

- 2 From the 5 black cushions supplied with the VGS-1, select the thickest rectangular cushion (20 x 30 x 12 mm) and attach it to the top surface of the VGS-1 unit.
 - To prevent interference to the terminal of the VGS-1, ensure that you attach the thick square cushion to the baseplate surface.

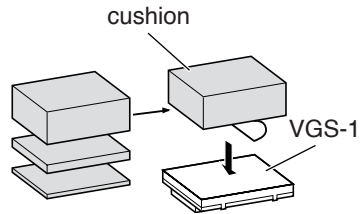

- 3 From the remaining cushions, select the thickest square cushion (21 x 21 x 2.5 mm) and attach it to the printed circuit board.
 - The remaining cushions are not used with this transceiver.
 - Ensure that the cushion is placed within the guidelines on the PCB.

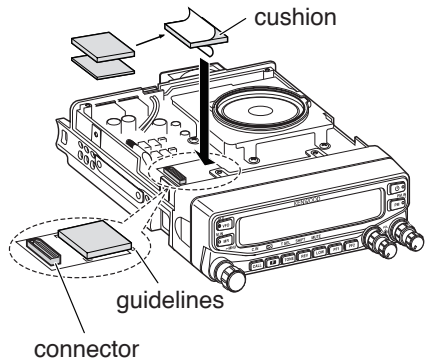

- 4 Insert the VGS-1 unit into the connector on the transceiver.
 - Press down on the top of the VGS-1 unit to ensure that it is securely attached to the connector.

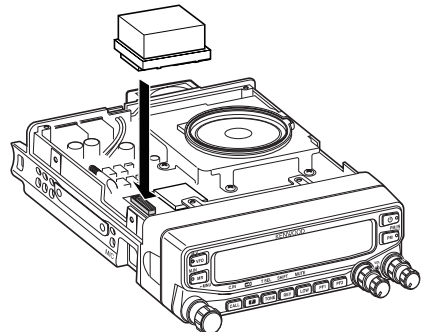

- 5 Replace the cover on the base unit and secure it using the 8 screws.

MAINTENANCE

GENERAL INFORMATION

This product has been factory aligned and tested to specification before shipment. Attempting service or alignment without factory authorization can void the product warranty.

SERVICE

When returning this product to your dealer or service center for repair, pack it in its original box and packing material. Include a full description of the problem(s) experienced. Include your telephone number along with your name and address in case the service technician needs to contact you; if available, also include your fax number and e-mail address. Don't return accessory items unless you feel they are directly related to the service problem.

You may return this product for service to the authorized **Kenwood** dealer from whom you purchased it, or any authorized **Kenwood** service center. Please do not send subassemblies or printed circuit boards; send the complete product. A copy of the service report will be returned with the product.

SERVICE NOTE

If you desire to correspond on a technical or operational problem, please make your note legible, short, complete, and to the point. Help us help you by providing the following:

- Model and serial number of equipment
- Question or problem you are having
- Other equipment in your station pertaining to the problem



CAUTION

Do not pack the equipment in crushed newspapers for shipment! Extensive damage may result during rough handling or shipping.

Note:

- ◆ Record the date of purchase, serial number and dealer from whom this product was purchased.
- ◆ For your own information, retain a written record of any maintenance performed on this product.
- ◆ When claiming warranty service, please include a photocopy of the bill of sale or other proof-of-purchase showing the date of sale.

CLEANING

To clean the case of this product, use a neutral detergent (no strong chemicals) and a damp cloth.

TROUBLESHOOTING

The problems described in this table are commonly encountered operational malfunctions and are usually not caused by circuit failure.

Problem	Probable Cause	Corrective Action
The transceiver will not power up after connecting a 13.8 V DC power supply and pressing [⏻]. Nothing appears on the display.	<ol style="list-style-type: none"> 1 The power cable was connected backwards. 2 One or more of the power cable fuses are open. 	<ol style="list-style-type: none"> 1 Connect the supplied DC power cable correctly (red to + terminal and black to – terminal). 2 Look for the cause of the blown fuse(s). After inspecting and correcting any problems, install a new fuse(s) with the same ratings.
The frequency cannot be selected by turning the Tuning control or by pressing microphone [UP]/[DWN].	Memory Recall was selected.	Press [VFO].
Most keys and the Tuning control do not function.	<ol style="list-style-type: none"> 1 One of the Lock functions is ON. 2 The transceiver is in Channel Display mode. 	<ol style="list-style-type: none"> 1 Unlock all of the Lock functions. 2 With the transceiver power OFF, press [REV] + Power ON to exit Channel Display mode.
Memory channels cannot be selected by turning the Tuning control or by pressing microphone [UP]/[DWN].	No data has been stored in any Memory channel.	Store data in some Memory channels.
You cannot transmit even though you are pressing [PTT].	<ol style="list-style-type: none"> 1 The microphone plug was not inserted completely into the transceiver. 2 You selected a transmit offset that places the transmit frequency outside the allowable range. 3 The external TNC is transmitting. 	<ol style="list-style-type: none"> 1 Switch the power OFF, then insert the microphone plug until the locking tab clicks in place. 2 Turn the offset shift function OFF. 3 Press [PTT] after the TNC has finished transmitting.

SPECIFICATIONS

Specifications are subject to change without notice due to advancements in technology.

General			TM-V71A	TM-V71E	TM-V71A
			K Type	E Type	M4 Type
Guaranteed range	Band A & B	TX & RX	144 ~ 148 MHz	144 ~ 146 MHz	
			438 ~ 450 MHz	430 ~ 440 MHz	
Frequency range	Band A	RX	118 ~ 524 MHz		—
	Band B		136 ~ 524 MHz		—
			800 ~ 1300 MHz (excluding cellular band)		—
Mode			F2D/ F3E		
Antenna impedance			50 Ω		
Operating temperature range			-20°C ~ +60°C (-4°F ~ +140°F)		
Power requirement			13.8 V DC ±15% (Negative ground)		
Frequency stability			Within ±5 ppm (-10°C ~ +50°C)		
Current	TX	VHF	Hi	Less than 13.0 A	
			Mid	Less than 5.5 A	
			Low	Less than 4.0 A	
		UHF	Hi	Less than 13.0 A	
			Mid	Less than 6.5 A	
			Low	Less than 5.0 A	
	RX		Less than 1.2 A (at 2W audio output)		
Dimensions (W x H x D)	Without projections		Panel: 140 x 43 x 38.2 mm (5.51" x 1.69" x 1.50") Body (with Panel): 140 x 43 x 180.7 mm (5.51" x 1.69" x 7.11")		
	With projections		Panel: 140 x 43 x 55.4 mm (5.51" x 1.69" x 2.18") Body (with Panel): 140 x 43 x 213.1 mm (5.51" x 1.69" x 8.39")		
Weight (approx.)			Body (with Panel): 1.5 kg (3.3 lbs)		

Transmitter		TM-V71A	TM-V71E	TM-V71A
		K Type	E Type	M4 Type
RF power output	Hi	50 W		—
	Mid	Approx. 10 W		25W
	Low	Approx. 5 W		
Modulation		Reactance modulation		
Maximum frequency deviation		Within ± 5 kHz		
Spurious radiation		Less than -60 dB		
Modulation distortion (300 Hz ~ 3 kHz)		Less than 3%		
Microphone impedance		600 Ω		

Receiver		TM-V71A	TM-V71E	TM-V71A
		K Type	E Type	M4 Type
Circuitry		Double super heterodyne		
Intermediate frequency	1st (Band A/ Band B)	45.05 MHz/ 49.95 MHz		
	2nd (Band A/ Band B)	455 kHz/ 450 kHz		
Sensitivity		Less than 0.16 μV		
Squelch sensitivity		Less than 0.1 μV		
Selectivity	-6 dB	More than 11 kHz		
	-50 dB	Less than 30 kHz		
Low frequency output (8 Ω)		More than 2 W (at 5% distortion)		

Concerning the received frequency display, an unmodulated signal may be received. This is according to the set intrinsic frequency form.

	<A band>	<B band>	
VxU reception	$(144 \text{ MHz} + 45.05 \text{ MHz}) \times 2$	$(430 \text{ MHz} - 49.95 \text{ MHz})$	$= 45.05 \text{ MHz}, 49.95 \text{ MHz}$
	$(144 \text{ MHz} + 45.05 \text{ MHz}) \times 4$	$(430 \text{ MHz} - 49.95 \text{ MHz}) \times 2$	$= 45.05 \text{ MHz}, 49.95 \text{ MHz}$
UxV reception	$(430 \text{ MHz} - 45.05 \text{ MHz})$	$(144 \text{ MHz} + 49.95 \text{ MHz}) \times 2$	$= 45.05 \text{ MHz}, 49.95 \text{ MHz}$
	$(430 \text{ MHz} - 45.05 \text{ MHz}) \times 2$	$(144 \text{ MHz} + 49.95 \text{ MHz}) \times 4$	$= 45.05 \text{ MHz}, 49.95 \text{ MHz}$

KENWOOD